

STAIR & RAILING PRODUCTS BY



HOUSE OF
FORGINGS



353 Greens Landing Dr.
Houston, Texas 77038

Toll Free 866.443.4848

Fax 281.443.1133

www.houseofforgings.net

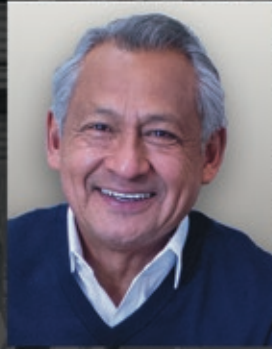

MANUEL VELA
PRESIDENT



BOB GREEN
VICE PRESIDENT



BOYD WINKLER
PRESIDENT OF SALES & MARKETING



JUSTIN PALAZZO
DIRECTOR OF MARKETING
& PRODUCT DEVELOPMENT



LACEY ENLOE
WA, OR, CA, AK, HI, ID, UT,
AZ, NM, CO, WY, MT, NV



CASSIE LUCHENE
SC, NC, VA, MD, WV, PA, NY, NJ,
RI, MA, CT, VT, NH, ME, CN, UK



MARGIE MELGAR
TX, OK, AR, LA, MS, TN, AL, GA, FL



SHELBY CARRANZA
ND, SD, NE, KS, MN, IA, MO,
WI, IL, IN, KY, OH

Please contact us for more
detailed information or for a
listing of suppliers near you.

Front cover photo:
ForestKraft blank newel with cove cap
6084 Handrail
Harmony Collection balusters

Edition 001-D

enloe@houseofforgings.net

cluchene@houseofforgings.net

mmelgar@hofllc.com

scarranza@houseofforgings.net

Whether your customer is a homeowner, retailer, or homebuilder, the timeless design and quality craftsmanship of House of Forgings' stair and railing products will attract the attention of the most discerning eye.

Our impeccably crafted styles are originally designed in partnership with our Italian studio and created with the sense of pride in workmanship that can only be found in an employee owned company. We fashion stairs and railings from the finest materials available so that what you provide to your clients is unsurpassed in style, uncompromising in quality, and unmatched in elegance.

We manufacture over 2,000 active SKUs in over 200,000 square feet of warehouse space with a national distribution network that ships to you in under 24 hours. No one else comes close to the brilliantly executed design, construction, and service you'll experience only at House of Forgings.



Table of Contents

POWDER COATED & STAINLESS STEEL	3-63
Finishes & Patinas	4-5
Stainless Steel Cable Railing	6-9
Horizontal Bar Railing	10-15
Harmony	16-17
Soho	18-19
Foundation	20-21
Mega	22-23
Wentworth	24-27
Aalto	28-31
Tuscan	32-37
Designer	38-39
Monte Carlo	40-41
Stainless	42-43
Gothic	44-45
Round	46-49
Versatile	50-53
Ribbon	54-57
Twist	58-61
Accessories	62-63
FORGED PANELS	64-85
Rebecca	65-67
Tuscany	68-71
Seville	72-73
Milano	74-76
Bordeaux	78-81
Regency	82-85
WOOD	86-100
Newels & Balusters	88-93
Handrail & Fittings	94-95
Treads	96-97
Starter Steps	98
Lumber & Plywood	98
Moulding	99
Accessories	100
AXIA STAIR & RAILING SYSTEMS	101
SALES & MARKETING SUPPORT	102-103
CUSTOM IRON FABRICATION & FINISHING	104

Powder Coated & Stainless Steel

**House of Forgings
is the benchmark in
the stair and railing
industry, offering an
unsurpassed
selection of quality
products and
expert service.**

Our vast selection of products will meet the needs of even the most discerning customers. Whether selecting a powder coated finish or stainless steel, our newels, balusters and accessories will compliment a broad range of architectural styles.

STAIR & RAILING PRODUCTS BY



Finishes & Patinas



SATIN BLACK (STB)



ASH GREY (AG)



COPPER VEIN (CV)



OIL RUBBED COPPER (ORC)



OIL RUBBED BRONZE (ORB)

House of Forgings provides an unsurpassed selection of designs in the highest quality powder coated finishes available. Our hand applied patinas enhance the lines and hammered detail of each unique piece. As interior design trends move forward, count on us to carry the latest styles & finishes.

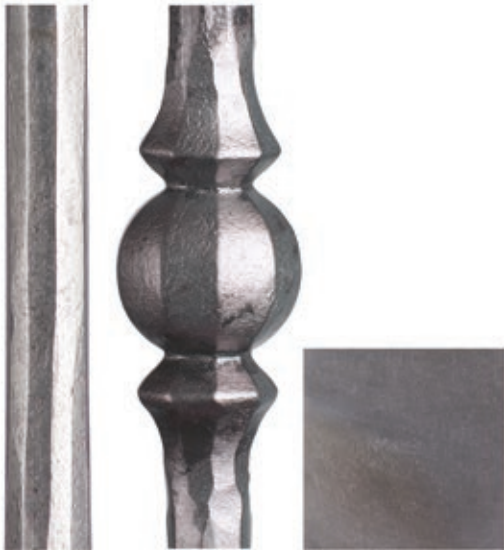

SATIN CLEAR (SC)

This is a clear finish over RAW/unfinished iron, variations in surface color may occur.



DORADO GOLD (GD)



STAINLESS STEEL (Satin Polish)



BRASS (Satin Polish)

Passivated to minimize tarnishing, use gloves when handling.



BRUSHED CHROME (BC)



NICKEL (NL)



POLISHED BRASS (PB)

THESE FINISHES HAVE BEEN PROFESSIONALLY PHOTOGRAPHED WITH THE HIGHEST INTEGRITY. OUR GOAL IS TO PRODUCE THE MOST REALISTIC MATCH TO THE ACTUAL FINISHES, HOWEVER SOME SLIGHT VARIANCES MAY OCCUR. All images are the sole property of House of Forgings, LLC, and cannot be copied or reproduced without written permission.

— Stainless Steel —
Cable Railing



Red Oak 4000 Newels, 6084 Handrail with stainless round bar bracket (shown)

Create the ideal modern aesthetic by combining stainless steel cable and rich oak. The expansive views allowed for by cable make it ideal for balconies as well as staircases.



SWAGED CABLE INFILL KITS FOR WOOD OR METAL POSTS

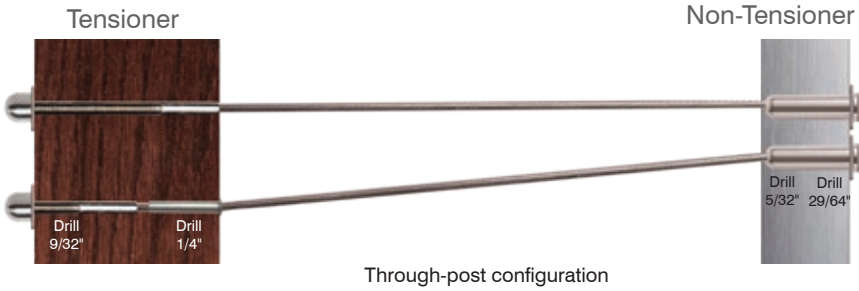

Through-post configuration

Outside to outside
Level/balcony or angle/stair
Steel or wood posts

HFC18.102-5	5'	.15 kgs (.331 lbs)
HFC18.102-10	10'	.227 kgs (.5 lbs)
HFC18.102-15	15'	.303 kgs (.669 lbs)
HFC18.102-20	20'	.383 kgs (.844 lbs)

Pre-assembled kit includes fittings and factory swaged cable in lengths 5'-20'

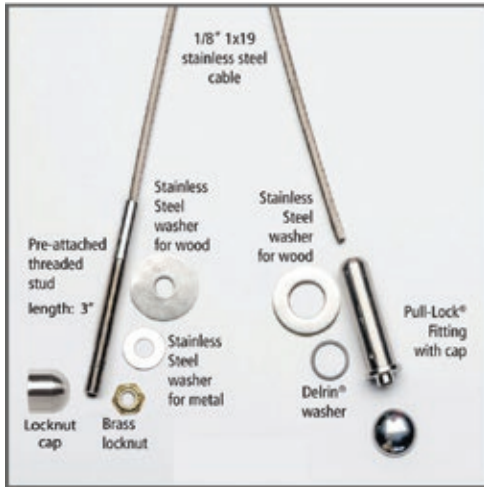

Included in kit



MINIMUM BREAKING STRENGTH - Cable Diameter 1/8" = 1,780 lbs.
1X19 STRAND TYPE 316 STAINLESS STEEL CABLE

1 x 19 Cable - 1/8" Diameter



AISI 316

Cable Cutter



HFC18.CUTTER

Cable cut-off wheel



HFC18.WHEEL

Drill Kit
Metal Post



AX00.070.635

Drill Kit
Wood Post



AX00.070.630

EASY AS 1-2-3

- 1. What posts are you using? Wood or metal?**
- 2. Measure your level and stair runs, calculate number of level and stair fittings.**
- 3. Add up tensioners and non-tensioners, then calculate total cable footage (plus 5%).**

Push-Lock® Fittings

Push-Lock fittings do not require any special tools for installation. Simply push the cable into the fitting and it locks.



Tension each row of cable equally to 225 lbs making sure not to over tighten. Use tension gauge to accurately measure tension.

Tension Gauge

HFC18.TENSION.GAUGE

Recommended Tensioning Sequence

SWAGELESS CABLE INFILL FOR WOOD OR METAL POSTS

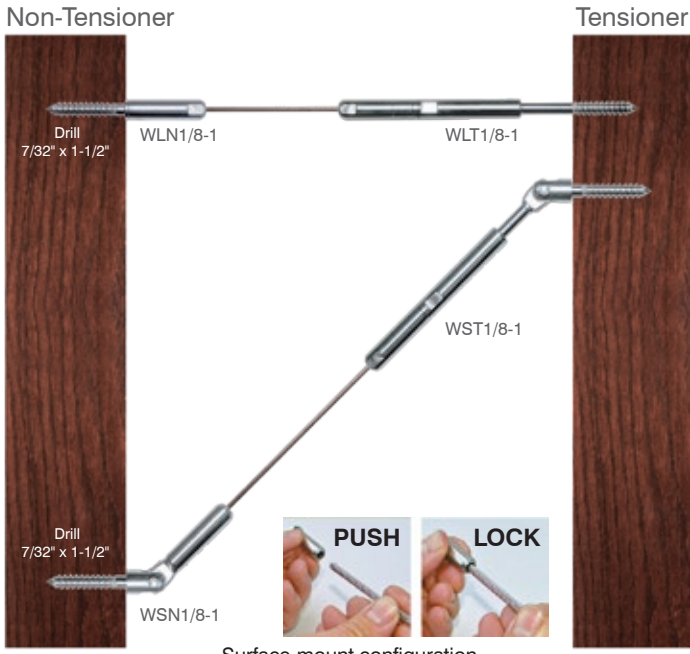

Inside to inside
Level/balcony or angle/stair
Wood posts

For use with 1/8" cable

WLN1/8-1	Wood Level Non Tensioner	.04 kgs (.092 lbs)
WLN1/8-10	Wood Level Non Tensioner(10 pack)	.31 kgs (.693 lbs)
WLT1/8-1	Wood Level Tensioner	.07 kgs (.173 lbs)
WLT1/8-10	Wood Level Tensioner(10 pack)	.68 kgs (1.5lbs)
WSN1/8-1	Wood Stair Non Tensioner	.06 kgs (.135 lbs)
WSN1/8-10	Wood Stair Non Tensioner(10 pack)	.5 kgs (1.12 lbs)
WST1/8-1	Wood Stair Tensioner	.09 kgs (.217 lbs)
WST1/8-10	Wood Stair Tensioner(10 pack)	.88 kgs (1.94 lbs)

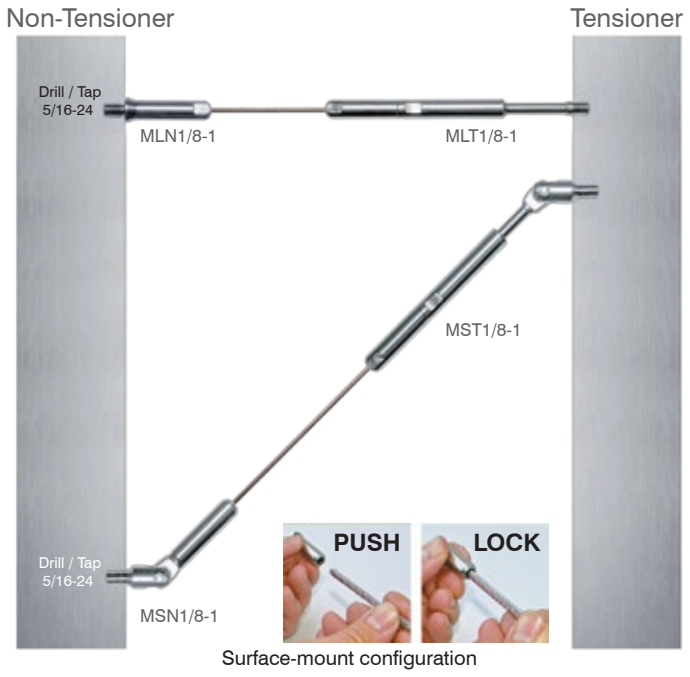
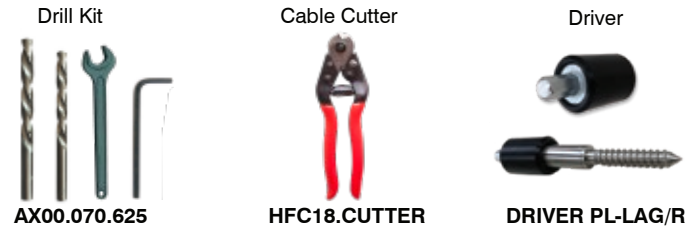

Inside to inside
Level/balcony or angle/stair
Metal posts

For use with 1/8" cable

MLN1/8-1	Metal Level Non Tensioner	.04 kgs (.087 lbs)
MLN1/8-10	Metal Level Non Tensioner(10 pack)	.29 kgs (.638lbs)
MLT1/8-1	Metal Level Tensioner	.07 kgs (.158 lbs)
MLT1/8-10	Metal Level Tensioner(10 pack)	.61 kgs (1.349 lbs)
MSN1/8-1	Metal Stair Non Tensioner	.05 kgs (.118 lbs)
MSN1/8-10	Metal Stair Non Tensioner(10 pack)	.6 kgs (1.349 lbs)
MST1/8-1	Metal Stair Tensioner	.09 kgs (.202 lbs)
MST1/8-10	Metal Stair Tensioner(10 pack)	.81 kgs (1.793 lbs)

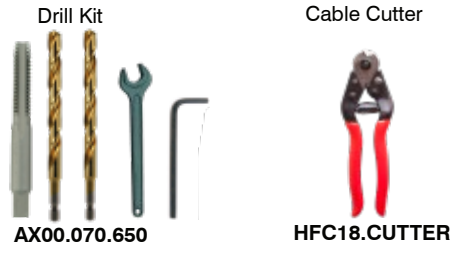

UTCABLE100-4	100' coil - 1/8" 1X19 type 316 S/S cable	2.07 kgs (4.56 lbs)
UTCABLE500-4	500' spool - 1/8" 1X19 type 316 S/S cable	10.02 kgs (22.1 lbs)

AISI 316



1x19 Cable(1/8" 316)

**MINIMUM BREAKING STRENGTH - Cable Diameter 1/8" = 1,780 lbs.
1X19 STRAND TYPE 316 STAINLESS STEEL CABLE**



HEAVY DUTY 8FT	SATIN BLACK	HFSTB5.1.1 (.078" - 2mm)	Powder Coated Tubular Round Bar 5/8" Dia. x 8'
HEAVY DUTY 5FT	SATIN BLACK	HFSTB5.1.1-5 (.078" - 2mm)	Powder Coated Tubular Round Bar 5/8" Dia. x 5'
STANDARD 8FT	SATIN BLACK	HFSTB7.1.1 (.039" - 1mm)	Powder Coated Tubular Round Bar 5/8" Dia. x 8'
STANDARD 5FT	SATIN BLACK	HFSTB7.1.1-5 (.039" - 1mm)	Powder Coated Tubular Round Bar 5/8" Dia. x 5'
EXTERIOR 6FT	SATIN BLACK	HFSTB8.1.1 (.059" - 1.5mm)	Powder Coated Tubular Round Bar 5/8" Dia. x 6'

Aluminum Exterior Powder Coating - A6063 - ISO11341:2004 - ISO2813:1994

HEAVY DUTY 8FT	OIL RUBBED BRONZE	HFORB5.1.1 (.078" - 2mm)	Powder Coated Tubular Round Bar 5/8" Dia. x 8'
-----------------------	--------------------------	---------------------------------	--

HEAVY DUTY 8FT	ASH GREY	HFAG5.1.1 (.078" - 2mm)	Powder Coated Tubular Round Bar 5/8" Dia. x 8'
-----------------------	-----------------	--------------------------------	--

HEAVY DUTY 8FT	STAINLESS STEEL	HFSS5.1.1 (.078" - 2mm)	304 Grade Stainless Steel Round Bar 5/8" Dia. x 8'
HEAVY DUTY 5FT	STAINLESS STEEL	HFSS5.1.1-5 (.078" - 2mm)	304 Grade Stainless Steel Round Bar 5/8" Dia. x 5'

Satin Polish Finish

Our tubular bar is made with superior 12 gauge(2 mm / 5/56") stock for minimal deflection

HORIZONTAL

R A I L I N G

Now available exclusively from House of Forgings, powder coated and stainless steel tubular round bars. These sleek 5/8" bars are available in a convenient 8' length, ideal for installation and affordable shipping. Mix and match them with our exclusive components for a look that is completely custom and uniquely you.



Satin Black (shown)

Photo courtesy of Mark Anderson Construction - Kennewick, WA



Stainless Steel (shown)

Photo courtesy of MJB Stairs - Shelby Township, MI



Stainless Steel (shown)



Ash Grey (shown)



Satin Black (shown)

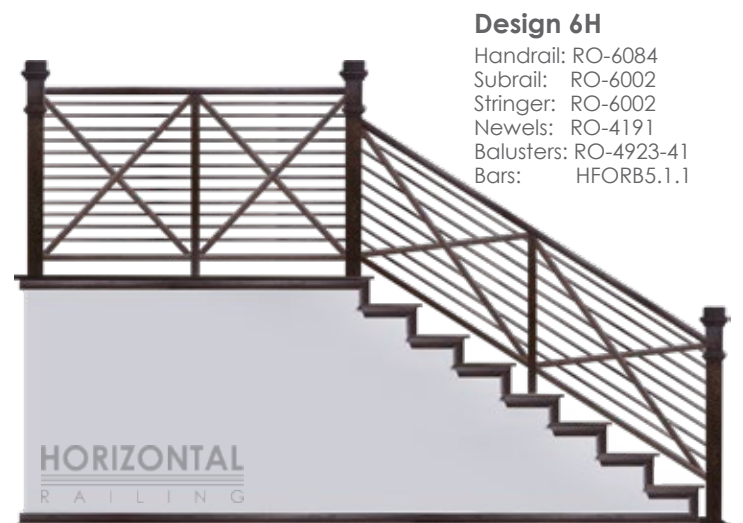
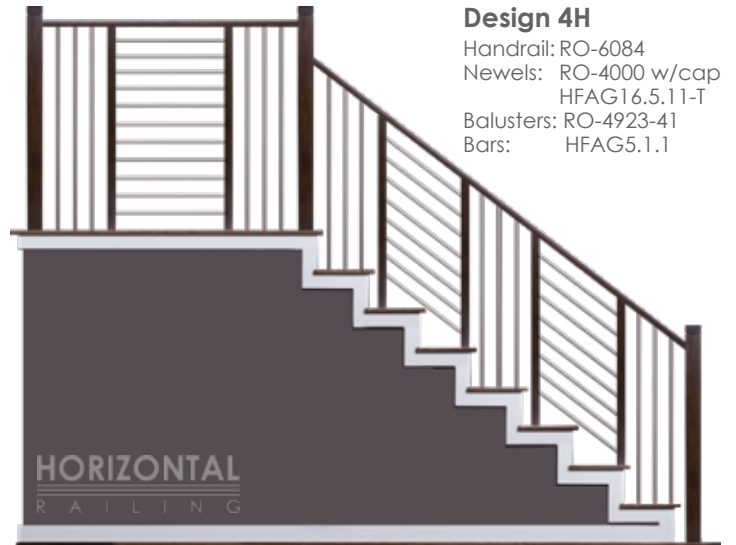
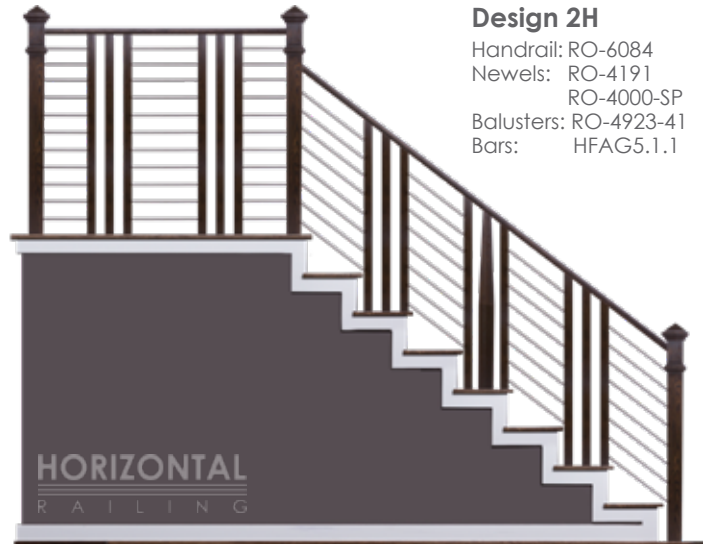
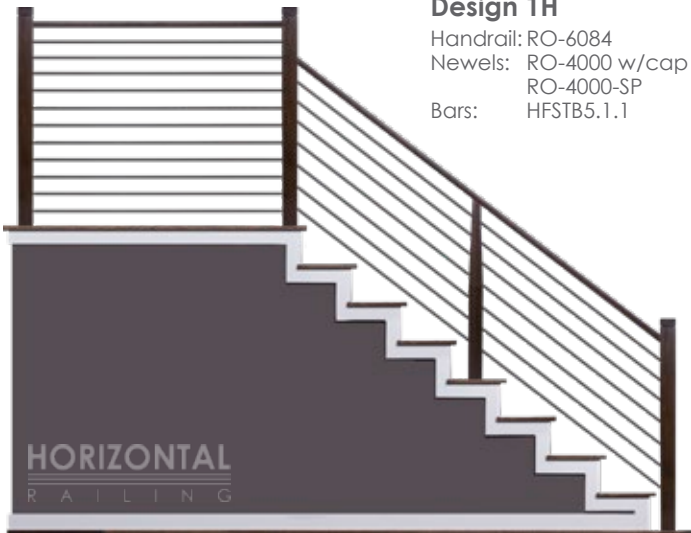



Design 1FK

Handrail: RO-6084

Newels:

Starting: RO-5400

Intermediate: RO-4400

Bars: HFSTB5.1.1

Design 2FK

Handrail: RO-6084

Newels:

Starting: RO-5900

Intermediate: RO-4900

Bars: HFSTB5.1.1



Design 3FK

Handrail: RO-6084

Newels:

Starting: RO-5000

Shown w/ optional COVE CAP-5000

Intermediate: RO-4000

Shown w/ optional COVE CAP-4000

Bars: HFSTB5.1.1



— Stainless Steel —
Cable Railing

HORIZONTAL
 R A I L I N G

ACCESSORIES



Box Newels

Non removable caps
 Stocked in Red Oak and White Oak



Routed Newels

Non removable caps
 Stocked in Red Oak and White Oak



Blank Newels

Optional caps available
 Stocked in Red Oak and White Oak



Blank Newel Caps

Available for : 3-1/4" and 5-1/2" blank newels
 Stocked in Red Oak and White Oak - Sold separately



Newel Bases

Stocked in Red Oak and White Oak
 Sold separately



Modern Handrail

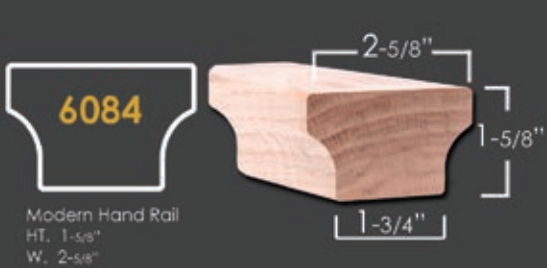

6084

Modern Hand Rail
HT. 1-5/8"
W. 2-5/8"

6084 Straight Rail
6084-B Bending Rail
fittings available. pg. 94-95

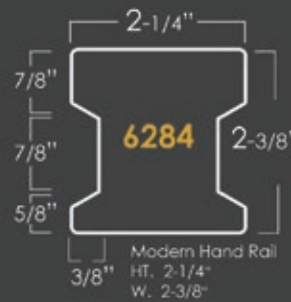

6284

Modern Hand Rail
HT. 2-1/4"
W. 2-3/8"



6284 Straight Rail
no fittings available

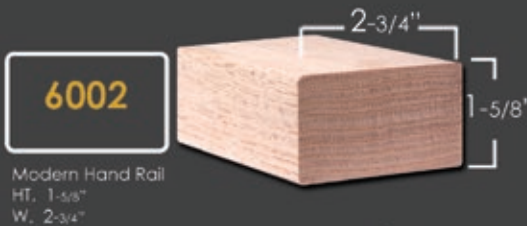

6002

Modern Hand Rail
HT. 1-5/8"
W. 2-3/4"

6002 Straight Rail
6002-B Bending Rail
no fittings available

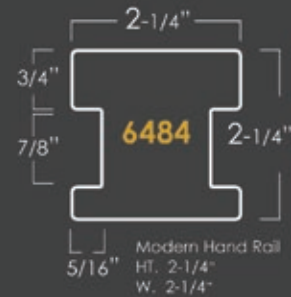

6484

Modern Hand Rail
HT. 2-1/4"
W. 2-1/4"



6484 Straight Rail
no fittings available



6060

Modern Hand Rail
HT. 1-1/16"
W. 2"

6060 Straight Rail
no fittings available

* All wood parts stocked in Red Oak and White Oak

ROUND STAINLESS NEWEL

ROUND NEWEL



(Newels or bars can be cut to length for handrail brackets)

HF 16.5.11
Ends: 1-3/16" Rd.
Height: 48"
Wt. 19 lbs.
SOLID

HF 16.5.11-T
Ends: 1-3/16" Rd.
Height: 48"
Wt. 5.7 lbs.
TUBULAR

HF17.1.2-T
Ends: 1-3/16" Rd.
Height: 47"
Wt. 5.7 lbs.
TUBULAR

Newel Mount Handrail Bracket



mounting hardware included



HF17.4001
Stainless Steel(304)
HT. 1-3/4"
Base = 1-1/2" sq.
ADJUSTABLE

HFSTB17.4001
Satin Black
HT. 1-3/4"
Base = 1-1/2" sq.
ADJUSTABLE

Wall Mount Handrail Bracket



mounting hardware included



HF17.4002
Stainless Steel(304)
HT. 2-1/2"
Base = 1-1/2" x 2"
Extends 3-1/4" off wall
ADJUSTABLE

HFSTB17.4002
Satin Black
HT. 2-1/2"
Base = 1-1/2" x 2"
Extends 3-1/4" off wall
ADJUSTABLE

Cable Gripping Pliers



HFC18.PLIERS

Cable Cutter



HFC18.CUTTER

Insert Tube



Length: 1-1/2"
HFC18.TUBE

Release Key



HFC18.KEY

Cable Cut-off Wheel



HFC18.WHEEL

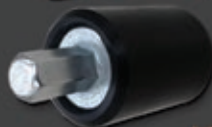

Lag Bolt Driver

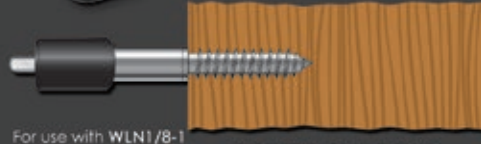

For use with WLN1/8-1 swageless cable fitting

DRIVER PL-LAG/R

Stainless Cleaner-Protectant



HFC18.CLEAN



Ash Grey (shown)



Ash Grey (shown)



16 Satin Black (shown)



Satin Black (shown)

CURATED TRANSITIONAL STYLE

HARMONY™

COLLECTION

AVAILABLE EXCLUSIVELY FROM HOF
ACCEPT NO IMITATIONS

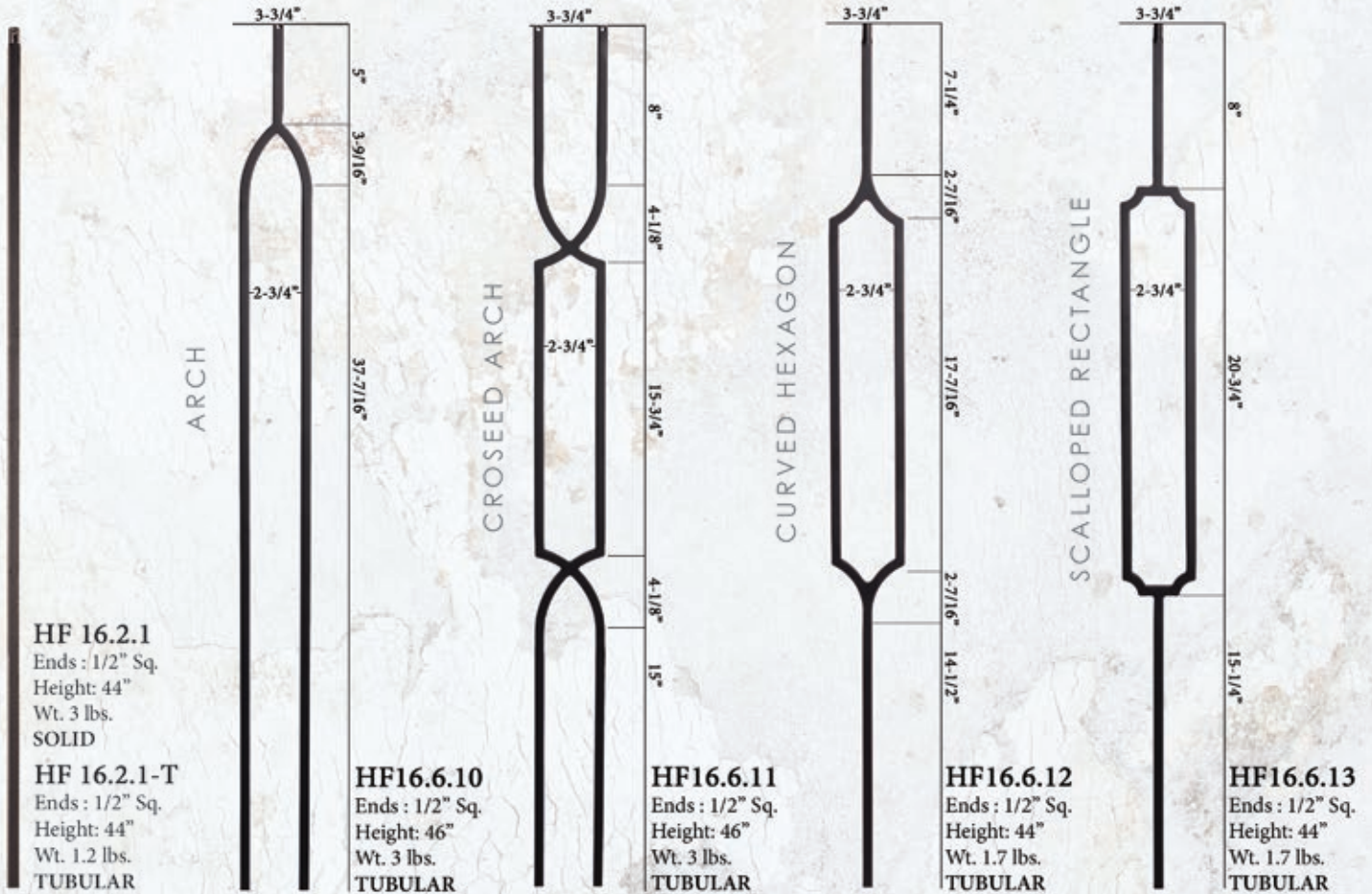

EXCLUSIVE



HF16.3.9
Level Base Collar - CAST IRON
Base : 1-9/16" Rd. - Height: 3/8" - Wt. .15 lbs.

HF16.3.60
Level Base Collar - ALUMINUM
Base : 1-9/16" Rd. - Height: 3/8" - Wt. .1 lbs.

EXCLUSIVE



HF16.3.70
Level Base Collar - ALUMINUM
Base : 1.33" Sq. - Height: .35" - Wt. .1 lbs.



HF16.3.19
Level Base Shoe w/Set Screw - ALUMINUM
Base : 1-5/16" Sq. - Height: 1" - Wt. .1 lbs.

EXCLUSIVE



HF16.3.61 Fits angles up to 40°
Angled Base Collar - ALUMINUM
Base : 1-9/16" Rd. - Height: 3/8" - Wt. .1 lbs.

EXCLUSIVE



HF16.3.71 Fits angles up to 40°
Angled Base Collar - ALUMINUM
Base : 1.33" Sq. - Height: .35" - Wt. .1 lbs.



HF16.3.2
Angle Base Shoe w/Set Screw - ALUMINUM
Base : 1-5/16" Sq. - Height: 1-7/8" - Wt. .15 lbs.

Photo courtesy of
Out Of The Woodworks - Arvada, CO

BALUSTRADE

SOHO™

AVAILABLE EXCLUSIVELY
FROM HOF
ACCEPT NO IMITATIONS

ITALY·USA
DESIGN COLLABORATIVE

PATENT PENDING

SOHO™ | BALUSTRADE

Customize your style like never before with the latest offering from HOF. Luxurious brass and stainless steel paired with black iron makes a bold statement.

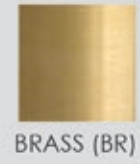

configuration options for your style



sleeves



newel mounting kit flange covers

Fits 1-3/16" Round Newels
 Diameter: 4.13" Height: .7"



Also available in Ash Grey.
 See page 62.



NEWEL MOUNTING KIT
 Fits 1-3/16" Round Newels
HF16.2.9



balusters/newels





AVAILABLE
EXCLUSIVELY
FROM HOF

ACCEPT
NO IMITATIONS

Photo courtesy of Homes by Sal Cohen - Bellevue, WA

Satin Black (shown)

ITALY · USA
DESIGN COLLABORATIVE

PATENT PENDING

FOUNDATION™

B A L U S T E R S

- TUBULAR
- NO COLLARS OR SHOES REQUIRED
- AFFORDABLE STYLE

SATIN BLACK

HFSTB16.7.5

1" Square (Tubular)

Weight: 1.15 lbs.
1/2" Square (Tubular)



ASH GREY

HFAG16.7.5



OIL RUBBED BRONZE

HFORB16.7.5



Bottom pin for quick installation!



Ash Grey (shown)



Photo courtesy of Home Lumber
New Haven, IN

Satin Black (shown)



Satin Black (shown)

MEGA_{COLLECTION}

Our most popular designs in a grand size



SIZE COMPARISON: Mega 3/4" vs. Standard 1/2"

MEGA_{COLLECTION}

Our most popular designs in a grand size

PERFECT FOR NEW CONSTRUCTION OR REMODEL
Create mega impact with these grand balusters

- Ideal for large or small staircases
- Perfect for replacing old wood balusters
- Traditional or modern base shoe/collar options

MEGA SQUARE



Finishes & Patinas



SATIN BLACK (STB)



ASH GREY (AG)











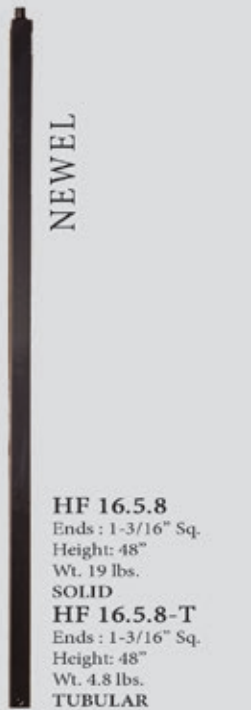

OIL RUBBED BRONZE (ORB)



Pintop
Diameter : 5/8"
Height : 3/4"

Tubular Bar Specifications
Superior 18 gauge wall thickness
(1/20" / 1.27mm)

 <p style="writing-mode: vertical-rl; transform: rotate(180deg);">NEWEL</p> <p>HF 16.5.8 Ends : 1-3/16" Sq. Height: 48" Wt. 19 lbs. SOLID</p> <p>HF 16.5.8-T Ends : 1-3/16" Sq. Height: 48" Wt. 4.8 lbs. TUBULAR</p>	 <p>HF 34.2.1-T Ends : 3/4" Sq. Height: 44" Wt. 1.5 lbs. TUBULAR</p>	 <p>HF 34.1.1-T Ends : 3/4" Sq. Height: 44" Wt. 1.5 lbs. TUBULAR</p>	 <p>HF 34.1.2-T Ends : 3/4" Sq. Height: 44" Wt. 1.5 lbs. TUBULAR</p>	 <p>HF 34.1.3-T Ends : 3/4" Sq. Height: 44" Wt. 2.45 lbs. TUBULAR</p>	 <p>HF 34.1.4-T Ends : 3/4" Sq. Height: 44" Wt. 3.35 lbs. TUBULAR</p>	 <p>HF 34.1.25-T Ends : 3/4" Sq. Height: 44" Wt. 5.05 lbs. TUBULAR</p>
---	--	--	--	--	---	--

 <p>HF 34.1.34-T Ends : 3/4" Sq. Height: 44" Wt. 1.75 lbs. TUBULAR</p>	 <p>HF 34.1.35-T Ends : 3/4" Sq. Height: 44" Wt. 2 lbs. TUBULAR</p>	<p style="text-align: center;">EXCLUSIVE</p>  <p>HF 34.6.1 Ends : 3/4" Sq. Height: 44" Wt. 3.25 lbs. TUBULAR</p> <p style="text-align: center;">Not available in ORB</p>	<p style="text-align: center;">EXCLUSIVE</p>  <p>HF 34.6.3 Ends : 3/4" Sq. Height: 44" Wt. 2.35 lbs. TUBULAR</p> <p style="text-align: center;">Not available in ORB</p>
---	--	---	---

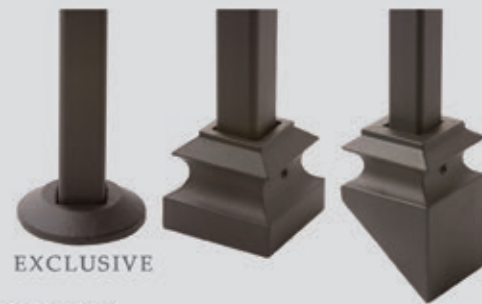

EXCLUSIVE

HF34.3.16
Level Base Collar - CAST IRON
Base : 2" Rd. - Height: 3/8" - Wt. .15 lbs.

HF34.3.19
Level Base Shoe w/Set Screw - ALUMINUM
Base : 1-7/8" Sq. - Height: 1-9/16" - Wt. .1 lbs.

HF34.3.2
Angle Base Shoe w/Set Screw - ALUMINUM
Base : 1-7/8" Sq. - Height: 2-7/8" - Wt. .15 lbs.

HF16.2.3
Newel Mounting Kit

For photos and full accessory details see pages 62-63





Oil Rubbed Bronze (shown)

WENTWORTH | COLLECTION

Inspired by old world English design, Wentworth Collection is an ode to an era of simple craftsmanship and metalsmithing. Hand forged design available in our most popular finishes & patinas.



Satin Clear (shown)



Satin Clear (shown)



Satin Black (shown)



Oil Rubbed Bronze (shown)

WENTWORTH

ROUND HAND FORGED SQUARE RUSTIC HAMMERED



Finishes & Patinas

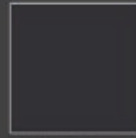

SATIN BLACK
(STB)



OIL RUBBED
BRONZE
(ORB)



SATIN CLEAR
(SC)

ACCESSORIES

Round level base shoes **HF16.3.35**
 Round angled base shoes **HF16.3.36**
 Round level base collar(modern) **HF16.3.12**

Photos: J.
 Photos: N.
 Photos: Q.

Square level base shoes **HF16.3.38**
 Square angled base shoes **HF16.3.39**
 Square level base collar(modern) **HF16.3.15**

Photos: C.
 Photos: G.
 Photos: P.

Round newel mounting kit **HF16.3.33**
 Square newel mounting kit **HF16.3.31**

Photos: U.
 Photos: T.

For photos and full accessory details see pages 62-63

<p style="text-align: center;">NEWEL</p> <p style="text-align: center;">47"</p>	<p style="text-align: center;">44"</p>	<p style="text-align: center;">9-1/2"</p> <p style="text-align: center;">2"</p> <p style="text-align: center;">7"</p> <p style="text-align: center;">2"</p> <p style="text-align: center;">7"</p> <p style="text-align: center;">2"</p> <p style="text-align: center;">14-1/2"</p>	<p style="text-align: center;">NEWEL</p> <p style="text-align: center;">47"</p>	<p style="text-align: center;">44"</p>	<p style="text-align: center;">9-1/2"</p> <p style="text-align: center;">1-1/2"</p> <p style="text-align: center;">7-3/4"</p> <p style="text-align: center;">1-1/2"</p> <p style="text-align: center;">7-3/4"</p> <p style="text-align: center;">1-1/2"</p> <p style="text-align: center;">14-1/2"</p>
<p>HF 1.1.22 Ends : 1" Rd. Height: 47" Wt. 18 lbs. SOLID</p>	<p>HF 3.1.1 Ends : 5/8" Rd. Height: 44" Wt. 3.6 lbs. SOLID</p>	<p>HF 3.1.2 Ends : 5/8" Rd. Height: 44" Wt. 3.58 lbs. SOLID</p>	<p>HF 1.1.23 Ends : 1" Sq. Height: 47" Wt. 18 lbs. SOLID</p>	<p>HF 3.2.1 Ends : 5/8" Sq. Height: 44" Wt. 4.28 lbs. SOLID</p>	<p>HF 3.2.2 Ends : 5/8" Sq. Height: 44" Wt. 5.2 lbs. SOLID</p>

Hand forged product, variance in specifications may occur.



Satin Black (shown)



Oil Rubbed Bronze (shown)

AALTO



Ash Grey (shown)

Satin Black (shown)

Our Aalto collection is a compliment to the modern design aesthetic. Adorn any space with the clean lines and open detail of these modern balusters and panels.



Satin Black (shown)



Ash Grey (shown)



Satin Black (shown)



Ash Grey (shown)



Satin Black (shown)



Ash Grey (shown)

AALTO

SQUARE



Finishes & Patinas

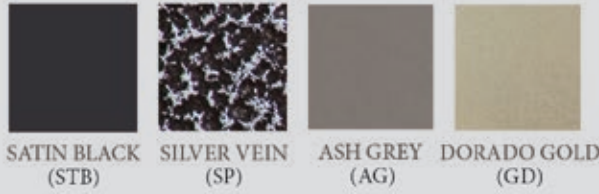

SATIN BLACK (STB) SILVER VEIN (SP) ASH GREY (AG) DORADO GOLD (GD)

	NEWELS	HF16.5.8	HF16.5.8-T	BALUSTERS	HF16.2.1	HF16.2.1-T	HF16.2.1-50	HF16.1.30	HF16.1.30-T	HF16.1.31	HF16.1.31-T	HF16.1.32	HF16.1.32-T	HF16.6.1	HF16.6.2	HF16.6.3	HF16.6.4	HF16.6.5	HF16.6.7	HF16.6.8	HF16.6.9	HF9.4.11	
STB		•			•	•	•	•		•		•		•	•	•	•	•	•	•	•	•	•
SP		•			•	•																	
AG			•			•			•	•		•	•	•	•	•	•	•	•	•	•	•	•
GD		•			•									•		•			•				

ACCESSORIES

- Level base shoes **HF16.3.1, HF16.3.19**
- Level base collars **HF16.3.4, HF16.3.5,**
- Angled base shoes **HF16.3.2, HF16.3.30**
- Adjustable level base shoes **HF16.3.44, HF16.3.46**
- Adjustable angle base shoes **HF16.3.45, HF16.3.47**
- Level base collars(modern) **HF16.3.9, HF16.3.60, HF16.3.70**
- Angled base collars(modern) **HF16.3.61, HF16.3.71**
- Newel mounting kit **HF16.2.3**

- Photos: A. A.
- Photos: D. H.
- Photos: E. G.
- Photos: R.
- Photos: S.
- Photos: P. O2. Q2
- Photos: O3. Q3
- Photos: T.

For photos and full accessory details see pages 62-63



Satin Black (shown)



NEWEL

HF 16.5.8
Ends : 1-3/16" Sq.
Height: 48"
Wt. 19 lbs.
SOLID

HF 16.5.8-T
Ends : 1-3/16" Sq.
Height: 48"
Wt. 4.8 lbs.
TUBULAR

HF 16.2.1
Ends : 1/2" Sq.
Height: 44"
Wt. 3 lbs.
SOLID

HF 16.2.1-T
Ends : 1/2" Sq.
Height: 44"
Wt. 1.2 lbs.
TUBULAR

HF 16.2.1-50
Ends : 1/2" Sq.
Height: 50"
Wt. 3.2 lbs.
SOLID



HF 16.1.30
Ends : 1/2" Sq.
Height: 44"
Wt. 3.4 lbs.
SOLID

HF 16.1.30-T
Ends : 1/2" Sq.
Height: 44"
Wt. 1.6 lbs.
TUBULAR



HF 16.1.31
Ends : 1/2" Sq.
Height: 44"
Wt. 3.6 lbs.
SOLID

HF 16.1.31-T
Ends : 1/2" Sq.
Height: 44"
Wt. 1.75 lbs.
TUBULAR



HF 16.1.32
Ends : 1/2" Sq.
Height: 44"
Wt. 10 lbs.
SOLID

HF 16.1.32-T
Ends : 1/2" Sq.
Height: 44"
Wt. 5 lbs.
TUBULAR



HF 16.6.1
Ends : 1/2" Sq.
Height: 44"
Wt. 2.5 lbs.
TUBULAR



HF 16.6.8
Ends : 1/2" Sq.
Height: 44"
Wt. 1.75 lbs.
TUBULAR



HF 16.6.9
Ends : 1/2" Sq.
Height: 44"
Wt. 1.6 lbs.
TUBULAR



HF 16.6.7
Ends : 1/2" Sq.
Height: 44"
Wt. 1.6 lbs.
TUBULAR



HF 16.6.2
Ends : 1/2" Sq.
Height: 44"
Wt. 1.6 lbs.
TUBULAR



HF 16.6.3
Ends : 1/2" Sq.
Height: 44"
Wt. 1.7 lbs.
TUBULAR



HF 16.6.4
Ends : 1/2" Sq.
Height: 44"
Wt. 1.7 lbs.
TUBULAR



HF 16.6.5
Ends : 1/2" Sq.
Height: 44"
Wt. 1.8 lbs.
TUBULAR

fits all angles up to 40 degrees



HF 9.4.11
Ends : 1/2" Sq.
Height: 46"
Wt. 4.5 lbs.
TUBULAR (Rake)



Satin Clear (shown)

Oil Rubbed Bronze (shown)

The craftsmanship in these hand-forged balusters exude character and beauty nearly impossible to duplicate. Our Tuscan series is available in both round forged and square hammered profiles. Bring the rustic charm of old world Italy into your home with this unique series.

TUSCAN



Satin Clear (shown)



Oil Rubbed Bronze (shown)

TUSCAN

ROUND HAND FORGED



Finishes & Patinas

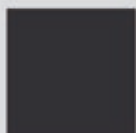

SATIN BLACK (STB)

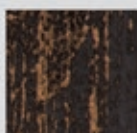

OIL RUBBED BRONZE (ORB)

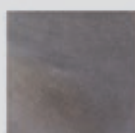

SATIN CLEAR (SC)

	NEWELS	HF1.1.22	HF1.1.9	HF1.1.21	BALUSTERS	HF2.9.21	HF2.1.5	HF2.1.6	HF2.1.7	HF2.1.9	HF2.1.8	HF2.1.11	HF2.6.8	HF2.6.9	HF2.6.7	HF2.10.2	HF2.10.4	HF2.10.3
STB		•	•	•		•	•	•	•	•	•	•	•	•	•	•	•	•
ORB						•	•	•	•	•	•	•	•	•	•	•	•	•
SC		•		•		•							•	•	•	•	•	•

ACCESSORIES

- Level base shoes
- Level base collars
- Angled base shoes
- Adjustable level base shoes
- Adjustable angle base shoes
- Level base collars(modern)

- HF16.3.26
- HF16.3.40, HF16.3.43
- HF16.3.27
- HF16.3.44, HF16.3.46
- HF16.3.45, HF16.3.47
- HF16.3.10

- Photos: J.
- Photos: K. O.
- Photos: N.
- Photos: R.
- Photos: S.
- Photos: Q.

For photos and full accessory details see pages 62-63





HF 2.1.9
 Ends : 9/16" Rd.
 Height: 44"
 Wt. 2.4 lbs.
SOLID



HF 2.1.8
 Ends : 9/16" Rd.
 Height: 44"
 Wt. 4.2 lbs.
SOLID



HF 2.1.11
 Ends : 9/16" Rd.
 Height: 44"
 Wt. 3 lbs.
SOLID



HF 2.6.8
 Ends : 9/16" Rd.
 Tapered
 Height: 44"
 Wt. 3.2 lbs.
SOLID



HF 2.6.9
 Ends : 9/16" Rd.
 Height: 44"
 Wt. 4.2 lbs.
SOLID



HF 2.6.7
 Ends : 9/16" Rd.
 Tapered
 Height: 44"
 Wt. 3.8 lbs.
SOLID



HF 2.9.21
 Ends : 9/16" Rd.
 Height: 44"
 Wt. 2.4 lbs.



HF 2.10.2
 Ends : 9/16" Rd.
 Height: 44"
 Wt. 3.2 lbs.
SOLID



HF 2.10.4
 Ends : 9/16" Rd.
 Height: 44"
 Wt. 4.2 lbs.
SOLID



HF 2.10.3
 Ends : 9/16" Rd.
 Height: 44"
 Wt. 3.6 lbs.
SOLID

TUSCAN

SQUARE HAND HAMMERED



Finishes & Patinas



SATIN BLACK (STB)



OIL RUBBED BRONZE (ORB)

	NEWELS	HF1.1.14-T	BALUSTERS	HF2.9.12	HF2.9.11	HF2.9.13	HF2.9.3	HF2.9.4	HF2.9.8	HF2.9.5	HF2.9.6	HF2.1.2	HF2.1.1	HF2.9.20	HF2.9.20-T	HF2.9.28	HF2.9.28-T	HF2.9.27	HF2.9.26	HF2.9.26-T	HF2.9.29	HF2.9.36	HF2.9.37
STB		•		•	•	•	•	•	•	•	•	•	•	•	•	•	•	•	•	•	•	•	•
ORB				•	•	•	•	•	•	•	•	•	•	•	•	•	•	•	•	•	•	•	•

ACCESSORIES

Level base shoes

Level base collars

Angled base shoes

Adjustable level base shoes

Adjustable angle base shoes

Level base collars(modern)

Newel mounting kit

HF16.3.25

HF16.3.41, HF16.3.42

HF16.3.28

HF16.3.44, HF16.3.46

HF16.3.45, HF16.3.47

HF16.3.11

HF16.3.31

Photos: C.

Photos: D. H.

Photos: G.

Photos: R.

Photos: S.

Photos: P.

Photos: T.

For photos and full accessory details see pages 62-63



NEWEL

47-1/4"

HF 1.1.14-T

Ends : 1" Sq.
Height: 47-1/4"
Wt. 2.30 lbs.
TUBULAR



HF 2.9.20

Ends : 9/16" Sq.
Height: 44"
Wt. 3 lbs.

SOLID

HF 2.9.20-T

Ends : 9/16" Sq.
Height: 44"
Wt. 1.05 lbs.
TUBULAR



17-1/2"

4-1/2"

22"

HF 2.9.12

Ends : 9/16" Sq.
Tapered
Height: 44"
Wt. 3.8 lbs.
SOLID



5"

12-1/2"

14-1/2"

17"

HF 2.9.11

Ends : 9/16" Sq.
Height: 44"
Wt. 5 lbs.
SOLID



10"

4-1/2"

10-1/2"

4-1/2"

14-1/2"

HF 2.9.13

Ends : 9/16" Sq.
Tapered
Height: 44"
Wt. 5.5 lbs.
SOLID

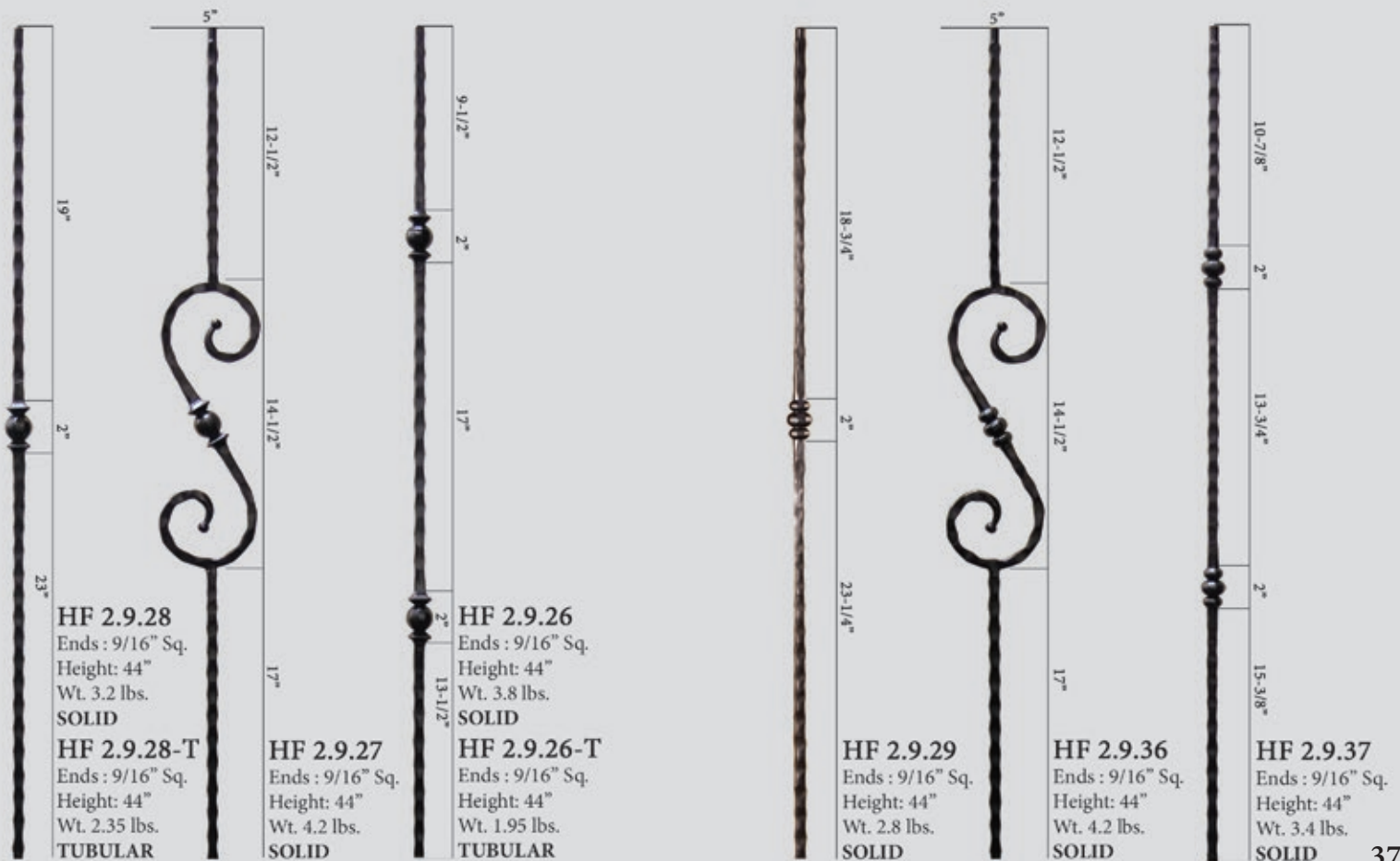

MONTE CARLO



Oil Rubbed Bronze (shown)

Drawing inspiration from the great Roman columns, the Monte Carlo series stands alone in style and elegance. The robust designs compliment the prominence of even the grandest estates. The intricately cast components are highlighted by the Oil Rubbed Bronze patina.

Satin Black (shown)



MONTE CARLO

ROUND



Finishes & Patinas

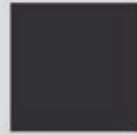

SATIN BLACK
(STB)



OIL RUBBED
BRONZE
(ORB)



NEWEL

HF 18.1.1-T
Ends : 1-3/16" Rd.
Height: 48"
Wt. 18.55 lbs.
TUBULAR

*Middle section is hollow cast iron,
ends are hollow cast steel



HF 18.2.1-T
Ends : 5/8" Rd.
Height: 44"
Wt. 1.75 lbs.
TUBULAR

*Middle section is hollow cast aluminum, ends are hollow cast steel



HF 18.2.2-T
Ends : 5/8" Rd.
Height: 44"
Wt. 1.50 lbs.
TUBULAR

ACCESSORIES

- Level base shoes
- Angled base shoes
- Level base collars(modern)
- Newel mounting kit

- HF16.3.50**
- HF16.3.51**
- HF16.3.12**
- HF16.3.14**

- Photos: I.
- Photos: M.
- Photos: Q.
- Photos: U.

For photos and full accessory details see pages 62-63



DESIGNER



Photo courtesy of Fix Carpentry - Parker, CO

Satin Black (shown)

The designer series offers an upgraded look at an affordable price for homebuilders and homeowners alike. These hollow balusters are offered in square bar stock and compliment a wide range of architectural styles.

Oil Rubbed Bronze (shown)



Satin Black (shown)

DESIGNER TUBULAR

SQUARE



Finishes & Patinas



SATIN BLACK
(STB)



OIL RUBBED
BRONZE
(ORB)



HF 16.8.6
Ends : 5/8" Sq.
Height: 44"
Wt. 2 lbs.
TUBULAR



HF 16.8.10
Ends : 5/8" Sq.
Height: 44"
Wt. 2 lbs.
TUBULAR



HF 16.8.11
Ends : 5/8" Sq.
Height: 44"
Wt. 2 lbs.
TUBULAR



HF 16.8.8
Ends : 5/8" Sq.
Height: 44"
Wt. 3 lbs.
TUBULAR



HF 16.8.9
Ends : 5/8" Sq.
Height: 44"
Wt. 4 lbs.
TUBULAR

ACCESSORIES

- Level base shoes
- Angled base shoes
- Level base collars(modern)

HF16.3.38
HF16.3.39
HF16.3.15

Photos: J. C.
Photos: N. G.
Photos: P.

For photos and full accessory details see pages 62-63



STAINLESS STEEL



Stainless steel is a mainstay in the modern and contemporary home decor market. The simple, honest lines of this profile is the perfect compliment to your urban dwelling. Now, offered in a more affordable tubular style for the budget savy buyer.

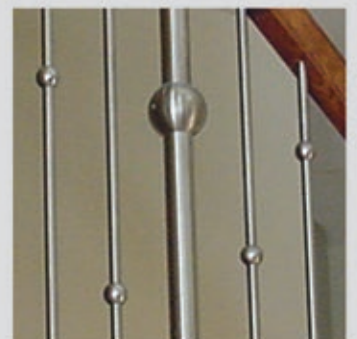

STAINLESS STEEL

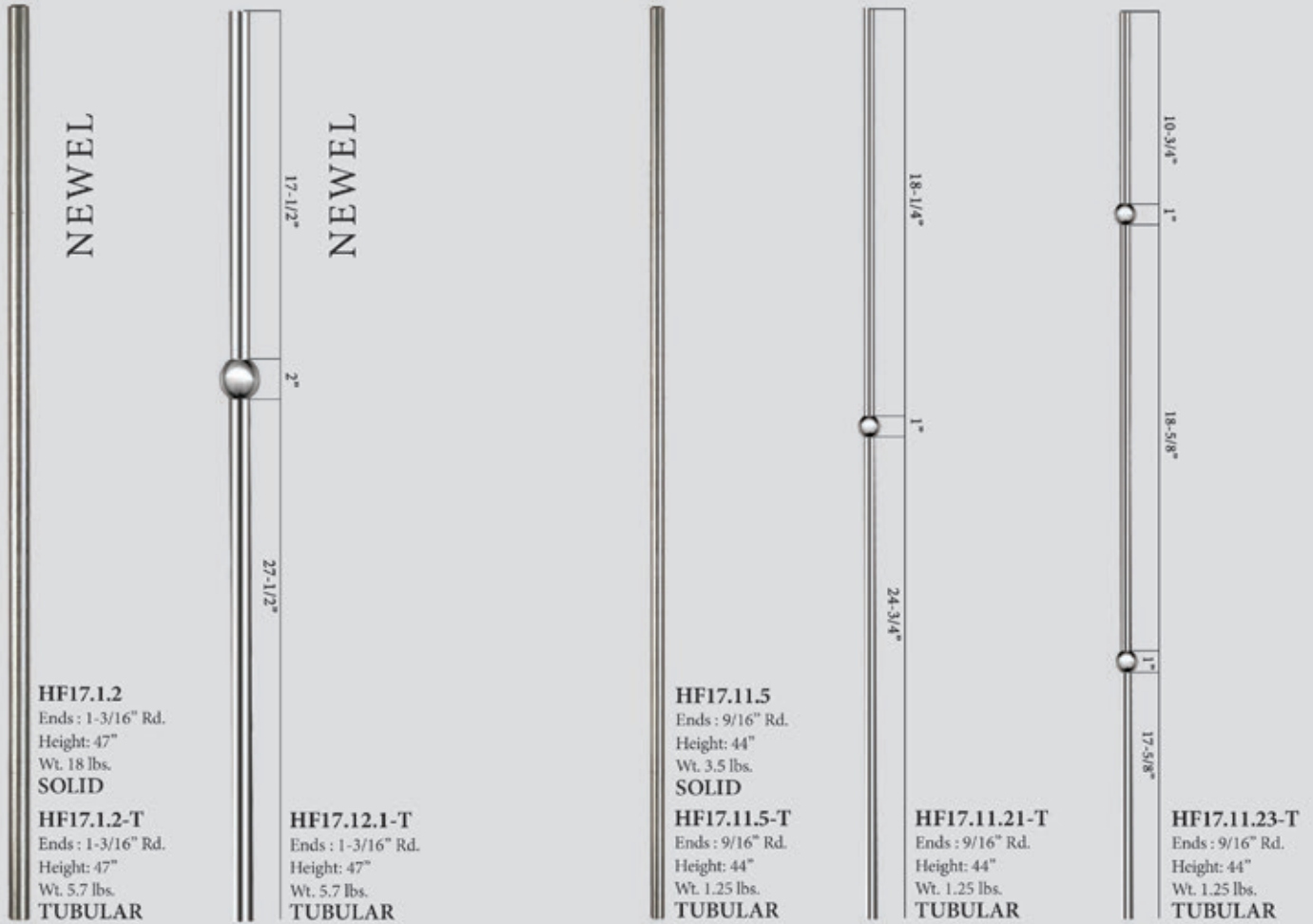

ACCESSORIES

Level base collar
Newel mounting kit

HF17.11.22
HF17.2.3

Photos: L.
Photos: V.

For photos and full accessory details see pages 62-63



GOTHIC



Satin Black (shown)

The inspiration for our Gothic series was the timeless ironwork featured in many European castles and estates. These prominent designs will compliment old world hardware and fixtures found throughout many homes today.

Oil Rubbed Copper (shown)

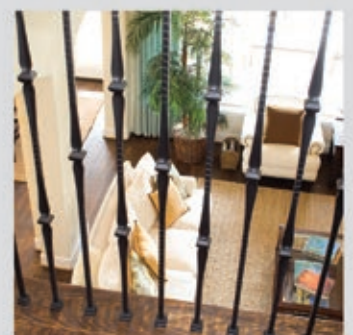

GOTHIC

SQUARE FACE HAMMERED



Finishes & Patinas



SATIN BLACK
(STB)



OIL RUBBED
BRONZE
(ORB)

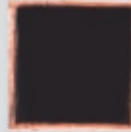

OIL RUBBED
COPPER
(ORC)



NEWEL

STB
(ONLY)

HF 16.5.6
Ends : 1-3/16" Sq.
Height: 48"
Wt. 22 lbs.

SOLID



HF 16.1.7
Ends : 9/16" Sq.
Height: 44"
Wt. 4 lbs.

SOLID

HF 16.1.7-T
Ends : 9/16" Sq.
Height: 44"
Wt. 1.3 lbs.

TUBULAR



HF 16.5.2
Ends : 9/16" Sq.
Height: 44"
Wt. 3.5 lbs.

SOLID

HF 16.5.2-T
Ends : 9/16" Sq.
Height: 44"
Wt. 1.5 lbs.

TUBULAR



HF 16.1.8
Ends : 9/16" Sq.
Height: 44"
Wt. 3.8 lbs.

SOLID

HF 16.1.8-T
Ends : 9/16" Sq.
Height: 44"
Wt. 1.7 lbs.

TUBULAR



HF 16.1.9
Ends : 9/16" Sq.
Height: 44"
Wt. 4.5 lbs.

SOLID

HF 16.1.9-T
Ends : 9/16" Sq.
Height: 44"
Wt. 1.7 lbs.

TUBULAR

*Tubular available in Satin Black only

ACCESSORIES

- Level base shoes
- Level base collars
- Angled base shoes
- Adjustable level base shoes
- Adjustable angle base shoes
- Level base collars(modern)
- Newel mounting kit

- HF16.3.3, HF16.3.20, HF16.3.25**
- HF16.3.41, HF16.3.42**
- HF16.3.17, HF16.3.28**
- HF16.3.44, HF16.3.46**
- HF16.3.45, HF16.3.47**
- HF16.3.11**
- HF16.2.3**

- Photos: A. A. C.
- Photos: D. H.
- Photos: E. G.
- Photos: R.
- Photos: S.
- Photos: P.
- Photos: T.

For photos and full accessory details see pages 62-63





Satin Black (shown)

The style of this collection provides a sleek appearance that strikes a perfect balance between traditional and contemporary.

Satin Black (shown)

ROUND



Oil Rubbed Bronze, Satin Black (shown)

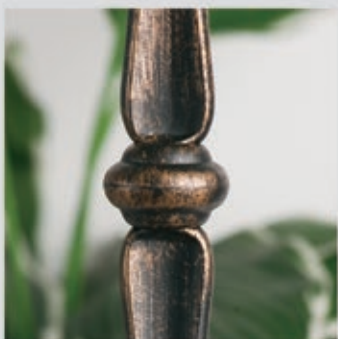

Oil Rubbed Bronze (shown)



Satin Black (shown)



Satin Black (shown)

ROUND ROUND SMOOTH



Finishes & Patinas



SATIN BLACK
(STB)



OIL RUBBED
BRONZE
(ORB)



ASH GREY
(AG)

	NEWELS	HF16.5.11	HF16.5.11-T	HF1.1.19	BALUSTERS	HF16.2.2	HF16.1.17	HF16.1.18	HF16.1.19	HF16.1.20	HF16.1.25-R	HF2.11.3	HF2.11.3-T	HF2.11.4	HF2.11.4-T	HF2.11.16	HF2.11.16-T	HF16.8.1	HF16.8.12	HF16.8.13	
STB		•		•		•	•	•	•	•	•	•	•	•	•	•	•	•	•	•	•
ORB													•		•						
AG			•																		



NEWEL

HF 16.5.11
Ends : 1-3/16" Rd.
Height: 48"
Wt. 19 lbs.
SOLID

HF 16.5.11-T
Ends : 1-3/16" Rd.
Height: 48"
Wt. 5.7 lbs.
TUBULAR



HF 16.2.2
Ends : 9/16" Rd.
Height: 44"
Wt. 2.7 lbs.
SOLID



HF 16.1.17
Ends : 9/16" Rd.
Height: 44"
Wt. 2.7 lbs.
SOLID



HF 16.1.18
Ends : 9/16" Rd.
Height: 44"
Wt. 3 lbs.
SOLID



HF 16.1.19
Ends : 9/16" Rd.
Height: 44"
Wt. 4 lbs.
SOLID



HF 16.1.20
Ends : 9/16" Rd.
Height: 44"
Wt. 5 lbs.
SOLID

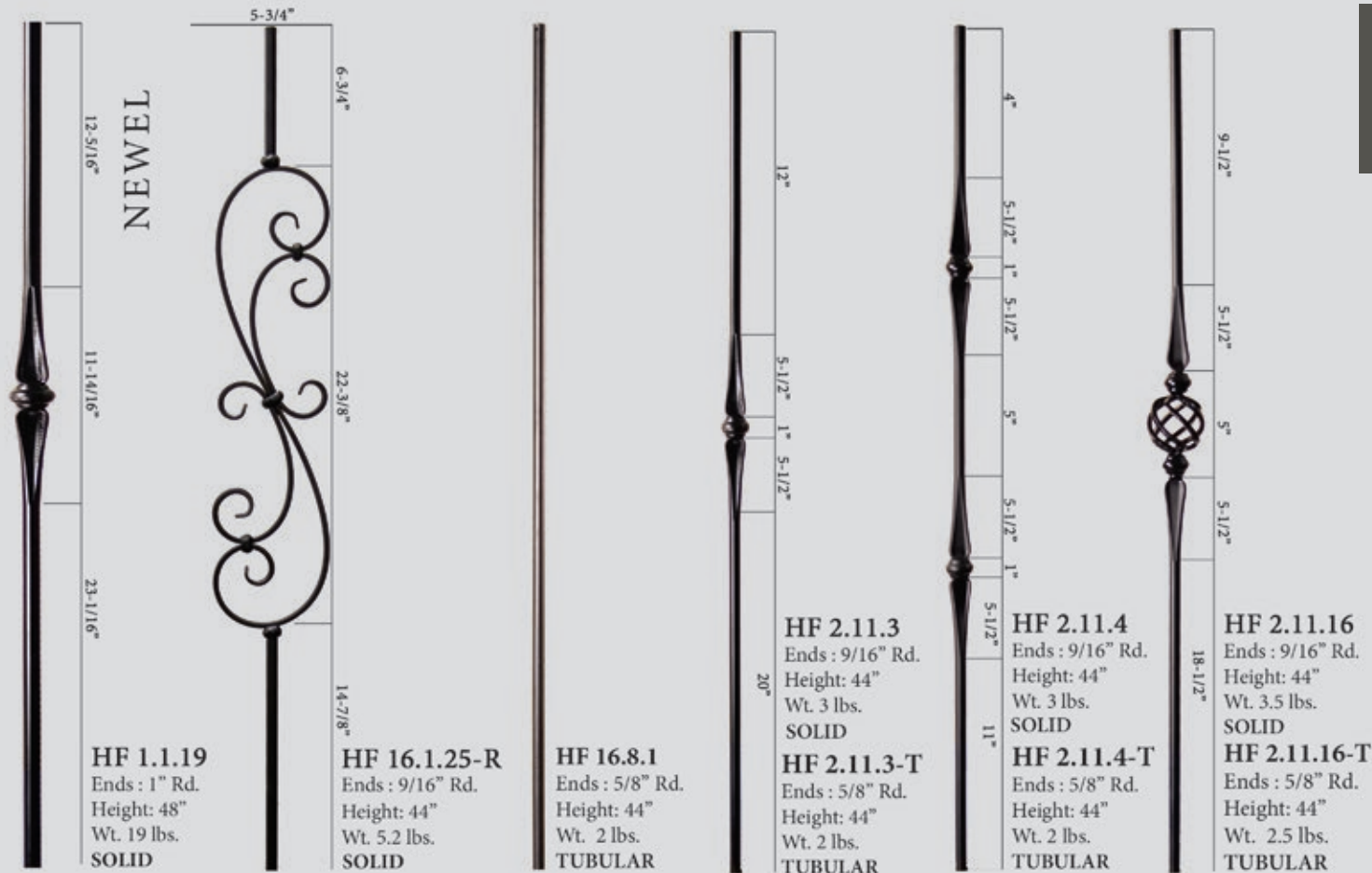

ACCESSORIES

- Level base shoes
- Level base collars
- Angled base shoes
- Adjustable level base shoes
- Adjustable angle base shoes
- Level base shoe, fits 5/8"
- Angled base shoe, fits 5/8"
- Level base collars(modern)
- Newel mounting kit

- HF16.3.13, HF16.3.26**
- HF16.3.40, HF16.3.43**
- HF16.3.16, HF16.3.27**
- HF16.3.44, HF16.3.46**
- HF16.3.45, HF16.3.47**
- HF16.3.35**
- HF16.3.36**
- HF16.3.10, HF16.3.12**
- HF16.3.14, HF16.3.33, HF16.2.9**

- Photos: L. J.
- Photos: K. O.
- Photos: M. N.
- Photos: R.
- Photos: S.
- Photos: J.
- Photos: N.
- Photos: Q.
- Photos: U.

For photos and full accesory details see pages 62-63 



Ash Grey (shown)

The endless baluster combinations in this series offers a match for your individual taste and style. These balusters compliment our Scroll, Twist and Ribbon series.

Ash Grey (shown)

VERSATILE

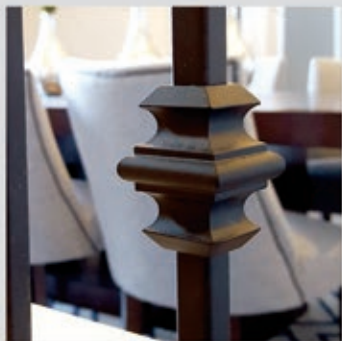

Satin Black (shown)



Oil Rubbed Bronze (shown)



VERSATILE SQUARE



Finishes & Patinas

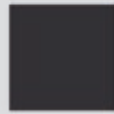

SATIN BLACK
(STB)



COPPER VEIN
(CV)



OIL RUBBED
BRONZE
(ORB)



OIL RUBBED
COPPER
(ORC)

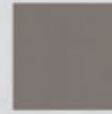

ASH GREY
(AG)

	NEWELS	HF16.5.8	HF16.5.8-T	HF16.5.9	BALUSTERS	HF16.2.1	HF16.2.1-T	HF16.2.1-50	HF16.1.34	HF16.1.34-T	HF16.1.35	HF16.1.35-T	HF16.1.45	HF16.1.45-T	HF2.10.1	HF2.2.3	HF16.1.25	HF16.1.25-T	HF16.1.25-S	
STB		•		•		•	•	•	•	•	•	•	•	•	•	•	•	•	•	•
AG			•				•			•		•							•	
CV						•	•			•		•					•	•		
ORB		•				•	•		•	•	•	•			•	•	•	•	•	•
ORC		•				•	•		•	•	•	•			•		•	•	•	•



NEWEL

HF 16.5.8
Ends : 1-3/16" Sq.
Height: 48"
Wt. 19 lbs.
SOLID



NEWEL

HF 16.5.9
Ends : 1-3/16" Sq.
Height: 48"
Wt. 20 lbs.
SOLID



HF 16.2.1
Ends : 1/2" Sq.
Height: 44"
Wt. 3 lbs.
SOLID

HF 16.2.1-T
Ends : 1/2" Sq.
Height: 44"
Wt. 1.2 lbs.
TUBULAR

HF 16.2.1-50
Ends : 1/2" Sq.
Height: 50"
Wt. 3.2 lbs.
SOLID



HF 16.1.34
Ends : 1/2" Sq.
Height: 44"
Wt. 4 lbs.
SOLID

HF 16.1.34-T
Ends : 1/2" Sq.
Height: 44"
Wt. 1.35 lbs.
TUBULAR



HF 16.1.35
Ends : 1/2" Sq.
Height: 44"
Wt. 3.5 lbs.
SOLID

HF 16.1.35-T
Ends : 1/2" Sq.
Height: 44"
Wt. 1.5 lbs.
TUBULAR



HF 16.1.45
Ends : 1/2" Sq.
Height: 44"
Wt. 4 lbs.
SOLID

HF 16.1.45-T
Ends : 1/2" Sq.
Height: 44"
Wt. 1.55 lbs.
TUBULAR



HF 2.10.1
Ends : 1/2" Sq.
Height: 44"
Wt. 4.2 lbs.
SOLID



HF 2.2.3
Ends : 1/2" Sq.
Height: 44"
Wt. 3 lbs.
SOLID



HF 16.1.25
Ends : 1/2" Sq.
Height: 44"
Wt. 5.2 lbs.
SOLID

HF 16.1.25-T
Ends : 1/2" Sq.
Height: 44"
Wt. 3.85 lbs.
TUBULAR



HF 16.1.25-S
Ends : 1/2" Sq.
Height: 44"
Wt. 5.2 lbs.
SOLID

ACCESSORIES

- Level base shoes
- Level base collars
- Angled base shoes
- Adjustable level base shoes
- Adjustable angle base shoes
- Level base collars(modern)
- Angled base collars(modern)
- Versatile style knuckle
- Newel mounting kit

- HF16.3.1, HF16.3.19, HF16.3.29**
- HF16.3.4, HF16.3.5,**
- HF16.3.2, HF16.3.30**
- HF16.3.44, HF16.3.46**
- HF16.3.45, HF16.3.47**
- HF16.3.9, HF16.3.60, HF16.3.70**
- HF16.3.61, HF16.3.71**
- HF16.5.1**
- HF16.2.3**

- Photos: A. A. C.
- Photos: D. H.
- Photos: E. G.
- Photos: R.
- Photos: S.
- Photos: P. O2. Q2
- Photos: O3. Q3
- Photos: F.
- Photos: T.

For photos and full accessory details see pages 62-63





Satin Black (shown)

The ribbon style twist in this series pairs nicely with balusters from the Scroll and Versatile series. The ribbon is accented nicely by the Oil Rubbed Bronze patina as well as the Copper Vein finish.

Satin Black (shown)

RIBBON



RIBBON SQUARE



Finishes & Patinas

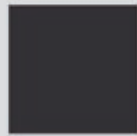

SATIN BLACK
(STB)



NEWEL

HF 16.5.7
Ends : 1-3/16" Sq.
Height: 48"
Wt. 19 lbs.
SOLID



HF 16.1.5
Ends : 1/2" Sq.
Height: 44"
Wt. 3.2 lbs.
SOLID



HF 16.1.6
Ends : 1/2" Sq.
Height: 44"
Wt. 3 lbs.
SOLID



HF 16.3.6
Ends : 1/2" Sq.
Height: 44"
Wt. 3.2 lbs.
SOLID



HF 16.3.7
Ends : 1/2" Sq.
Height: 44"
Wt. 4 lbs.
SOLID



HF 16.1.10
 Ends : 1/2" Sq.
 Height: 44"
 Wt. 3.6 lbs.
SOLID



HF 16.1.11
 Ends : 1/2" Sq.
 Height: 44"
 Wt. 4.1 lbs.
SOLID

ACCESSORIES

- Level base shoes
- Level base collars
- Angled base shoes
- Adjustable level base shoes
- Adjustable angle base shoes
- Level base collars(modern)
- Angled base collars(modern)
- Versatile style knuckle
- Newel mounting kit

- HF16.3.1, HF16.3.19, HF16.3.29**
- HF16.3.4, HF16.3.5,**
- HF16.3.2, HF16.3.30**
- HF16.3.44, HF16.3.46**
- HF16.3.45, HF16.3.47**
- HF16.3.9, HF16.3.60, HF16.3.70**
- HF16.3.61, HF16.3.71**
- HF16.5.1**
- HF16.2.3**

- Photos: A. A. C.
- Photos: D. H.
- Photos: E. G.
- Photos: R.
- Photos: S.
- Photos: P. O2. Q2
- Photos: O3. Q3
- Photos: F.
- Photos: T.

For photos and full accessory details see pages 62-63





TWIST

Satin Black (shown)

This popular twist and basket design is a mainstay featured in many new homes. These balusters and newels are offered in an extensive range of finishes and patinas. They combine seamlessly with profiles from the Versatile series.

Oil Rubbed Copper (shown)



Satin Black (shown)

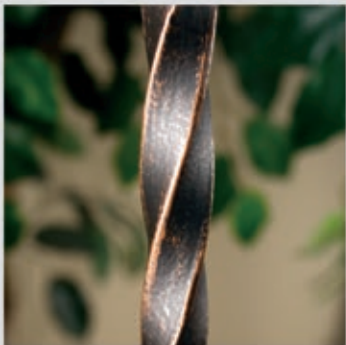

Oil Rubbed Bronze (shown)



Ash Grey (shown)

TWIST SQUARE



Finishes & Patinas



	NEWELS	HF16.5.4	HF16.5.4-T	HF16.5.5	HF16.5.5-T	BALUSTERS	HF16.1.1	HF16.1.1-T	HF16.1.2	HF16.1.2-T	HF16.1.3	HF16.1.3-T	HF16.1.4	HF16.1.4-T	HF16.1.21	HF16.1.21-T	HF16.1.16	HF16.1.41	
STB		•		•			•	•	•	•	•	•	•	•	•	•	•	•	•
AG			•		•			•		•		•		•		•			
CV							•	•	•	•	•	•	•	•	•	•			
ORB							•	•	•	•	•	•	•	•	•	•			
ORC							•	•	•	•	•	•	•	•	•	•			



NEWEL

13-1/4"

11-1/2"

23-1/4"

HF 16.5.4
Ends : 1-3/16" Sq.
Height: 48"
Wt. 18 lbs.
SOLID

HF 16.5.4-T
Ends : 1-3/16" Sq.
Height: 48"
Wt. 5.5 lbs.
TUBULAR



NEWEL

5-1/2"

7-1/4"

3-1/2"

6-1/2"

3-1/2"

7-1/4"

14-1/2"

HF 16.5.5
Ends : 1-3/16" Sq.
Height: 48"
Wt. 20 lbs.
SOLID

HF 16.5.5-T
Ends : 1-3/16" Sq.
Height: 48"
Wt. 7.6 lbs.
TUBULAR



15"

6"

23"

HF 16.1.1
Ends : 1/2" Sq.
Height: 44"
Wt. 3 lbs.
SOLID

HF 16.1.1-T
Ends : 1/2" Sq.
Height: 44"
Wt. 1.2 lbs.
TUBULAR



9"

6"

6"

6"

6"

17"

HF 16.1.2
Ends : 1/2" Sq.
Height: 44"
Wt. 3 lbs.
SOLID

HF 16.1.2-T
Ends : 1/2" Sq.
Height: 44"
Wt. 1.15 lbs.
TUBULAR



6"

6"

3"

5-1/2"

3-1/2"

6"

14"

HF 16.1.3
Ends : 1/2" Sq.
Height: 44"
Wt. 4 lbs.
SOLID

HF 16.1.3-T
Ends : 1/2" Sq.
Height: 44"
Wt. 1.55 lbs.
TUBULAR



8"

5-1/2"

8"

8"

5-1/2"

17"

HF 16.1.4
Ends : 1/2" Sq.
Height: 44"
Wt. 4 lbs.
SOLID

HF 16.1.4-T
Ends : 1/2" Sq.
Height: 44"
Wt. 1.95 lbs.
TUBULAR

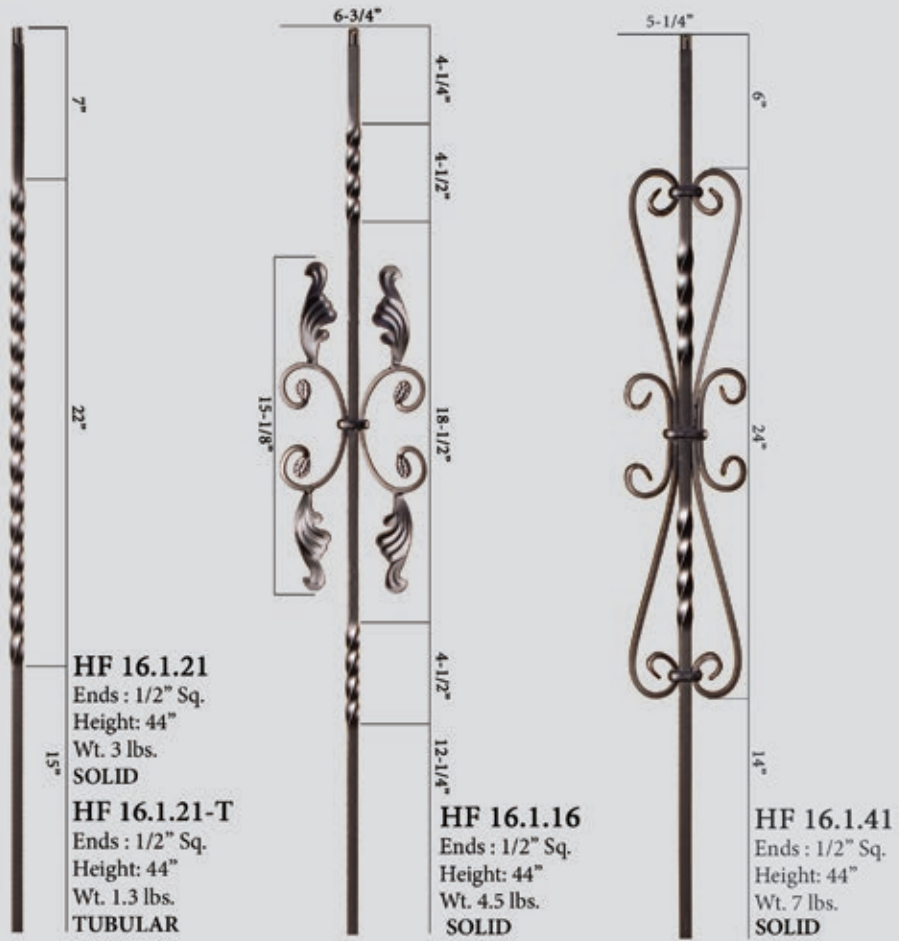

HF 16.1.21
 Ends : 1/2" Sq.
 Height: 44"
 Wt. 3 lbs.
SOLID

HF 16.1.21-T
 Ends : 1/2" Sq.
 Height: 44"
 Wt. 1.3 lbs.
TUBULAR

HF 16.1.16
 Ends : 1/2" Sq.
 Height: 44"
 Wt. 4.5 lbs.
SOLID

HF 16.1.41
 Ends : 1/2" Sq.
 Height: 44"
 Wt. 7 lbs.
SOLID

ACCESSORIES

- Level base shoes
- Level base collars
- Angled base shoes
- Adjustable level base shoes
- Adjustable angle base shoes
- Level base collars(modern)
- Angled base collars(modern)
- Versatile style knuckle
- Newel mounting kit

- HF16.3.1, HF16.3.19, HF16.3.29**
- HF16.3.4, HF16.3.5,**
- HF16.3.2, HF16.3.30**
- HF16.3.44, HF16.3.46**
- HF16.3.45, HF16.3.47**
- HF16.3.9, HF16.3.60, HF16.3.70**
- HF16.3.61, HF16.3.71**
- HF16.5.1**
- HF16.2.3**

- Photos: A. A. C.
- Photos: D. H.
- Photos: E. G.
- Photos: R.
- Photos: S.
- Photos: P. O2. Q2
- Photos: O3. Q3
- Photos: F.
- Photos: T.

For photos and full accessory details see pages 62-63



Photo	Part #	Description	ACCESSORY SPECIFICATIONS	STB	AG	CV	ORB	ORC	SC	GD
1/2" Square Baluster Accessories										
A.	HF16.3.1	Level base shoe, fits 1/2" square balusters, 1-5/16" square base, aluminum		•		•		•		
A.	HF16.3.19	Level base shoe with set screw, fits 1/2" square balusters, 1-5/16" square base, aluminum		•	•	•	•	•		•
E.	HF16.3.2	Angled base shoe with set screw, fits 1/2" square balusters, 1-5/16" base, aluminum		•	•	•	•	•		•
B.	HF16.3.21	Level base shoe with screw mount, fits 1/2" square balusters, 1-9/16" square base, aluminum		•		•				
F.	HF16.5.1	Versatile style knuckle with set screw, fits 1/2" square balusters, 1-7/16" square, aluminum		•		•	•	•		
C.	HF16.3.29	Oil Rubbed Bronze, level base shoe with set screw, fits 1/2" square balusters, 1-1/4" square base, cast iron		•			•			
G.	HF16.3.30	Oil Rubbed Bronze, angled base shoe with set screw, fits 1/2" square balusters, 1-1/4" base, cast iron					•			
D.	HF16.3.4	Level base collar, fits 1/2" square balusters, 2" square base, aluminum		•		•	•	•		
H.	HF16.3.5	Level base collar, fits 1/2" square balusters, 1-15/16" round base, aluminum, (ORB - cast iron)		•		•	•	•		
P.	HF16.3.9	Level base collar, fits 1/2" square balusters, 1-9/16" round base, cast iron			•	•	•			•
O2.	HF16.3.60	Level base collar, fits 1/2" square balusters, 1-9/16" round base, aluminum		•	•					
O3.	HF16.3.61	Angled base collar, fits 1/2" square balusters, 1-9/16" round base, aluminum		•	•					
Q2.	HF16.3.70	Level base collar, fits 1/2" square balusters, 1.33" square base, aluminum		•						
Q3.	HF16.3.71	Angled base collar, fits 1/2" square balusters, 1.33" square base, aluminum		•						
9/16" Square Baluster Accessories										
A.	HF16.3.3	Level base shoe, fits 9/16" square balusters, 1-5/16" square base, aluminum		•		•		•		
A.	HF16.3.20	Level base shoe with set screw, fits 9/16" square balusters, 1-5/16" square base, aluminum		•			•	•		
E.	HF16.3.17	Angled base shoe with set screw, fits 9/16" square balusters, 1-5/16" base, aluminum		•			•	•		
C.	HF16.3.25	Level base shoe with set screw, fits 9/16" Tuscan square balusters, 1-1/4" square base, cast iron								
G.	HF16.3.28	Angled base shoe with set screw, fits 9/16" Tuscan square balusters, 1-1/4" base, cast iron		•			•		•	
D.	HF16.3.41	Level base collar, fits 9/16" square balusters, 2" square base, cast iron		•			•			
H.	HF16.3.42	Level base collar, fits 9/16" square balusters, 1-15/16" round base, cast iron					•			
P.	HF16.3.11	Level base collar, fits 9/16" square balusters, 1-3/4" round base, cast iron					•			
5/8" Square Baluster Accessories										
C.	HF16.3.38	Level base shoe with set screw, fits 5/8" square balusters, 1-1/4" square base, cast iron		•			•		•	
G.	HF16.3.39	Angled base shoe with set screw, fits 5/8" square balusters, 1-1/4" base, cast iron		•			•		•	
P.	HF16.3.15	Level base collar, fits 5/8" square balusters, 1-3/4" round base, cast iron		•			•			
3/4" Square Baluster Accessories										
A.	HF34.3.19	Level base shoe with set screw, fits 3/4" square balusters, 1-7/8" square base, aluminum		•	•		•			
E.	HF34.3.2	Angled base shoe with set screw, fits 3/4" square balusters, 1-7/8" square base, aluminum		•	•		•			
P.	HF34.3.16	Level base collar, fits 3/4" square balusters, 2" round base, cast iron		•	•		•			
9/16" Round Baluster Accessories										
I.	HF16.3.13	Level base shoe, fits 9/16" round balusters, 1-5/16" square base, aluminum		•						
M.	HF16.3.16	Angled base shoe with set screw, fits 9/16" round balusters, 1-5/16" base, aluminum		•						
J.	HF16.3.26	Level base shoe with set screw, fits 9/16" round balusters, 1-1/4" square base, cast iron		•			•		•	
N.	HF16.3.27	Angled base shoe with set screw, fits 9/16" round balusters, 1-1/4" base, cast iron		•			•		•	
K.	HF16.3.40	Level base collar, fits 9/16" round balusters, 2" square base, cast iron					•			
O.	HF16.3.43	Level base collar, fits 9/16" round balusters, 1-15/16" round base, cast iron					•			
Q.	HF16.3.10	Level base collar, fits 9/16" round balusters, 1-9/16" round base, cast iron		•			•			
L.	HF17.11.22	Level base collar, fits 9/16" round stainless steel balusters, 1-1/2" round base, stainless steel								
5/8" Round Baluster Accessories										
J.	HF16.3.35	Level base shoe with set screw, fits 5/8" round balusters, 1-1/4" square base, cast iron		•	•		•		•	
N.	HF16.3.36	Angled base shoe with set screw, fits 5/8" round balusters, 1-1/4" base, cast iron		•	•		•		•	
I.	HF16.3.50	Level base shoe with set screw, fits 5/8" round balusters, 1-5/16" square base, aluminum		•			•			
M.	HF16.3.51	Angled base shoe with set screw, fits 5/8" round balusters, 1-5/16" base, aluminum		•			•			
Q.	HF16.3.12	Level base collar, fits 5/8" round balusters, 1-9/16" round base, cast iron		•	•		•			
Adjustable Shoes/Collars have a flexible insert that allows them to be used with either square or round balusters ranging in size from 1/2" to 9/16". Epoxy must be used to permanently secure.										
R.	HF16.3.44	Level base shoe, fits 1/2" - 9/16" square or round balusters, 1-5/16" square base, cast iron		•			•		•	
R.	HF16.3.46	Level base shoe, fits 1/2" - 9/16" square or round balusters, 1-1/2" square base, cast iron		•			•		•	
S.	HF16.3.45	Angled base shoe, fits 1/2" - 9/16" square or round balusters, 1-5/16" base, cast iron					•		•	
S.	HF16.3.47	Angled base shoe, fits 1/2" - 9/16" square or round balusters, 1-1/2" base, cast iron					•		•	
Newel Mounting Kits										
T.	HF16.2.3	Newel mounting kit with level base shoe, fits 1-3/16" square newels, 3-1/8" square base, cast iron		•	•		•	•		•
T.	HF16.3.31	Newel mounting kit with level base shoe, fits 1" square newels, 3-1/8" square base, cast iron		•			•		•	
T2.	HF16.3.72	Newel mounting kit with level base shoe, fits 1-3/16" square newels, 3.1" square base, .63" height, aluminum		•						
U.	HF16.3.14	Newel mounting kit with level base shoe, fits 1-3/16" round newels, 3-1/8" square base, cast iron		•	•		•		•	
U.	HF16.3.33	Newel mounting kit with level base shoe, fits 1" round newels, 3-1/8" square base, cast iron		•	•		•		•	
V.	HF17.2.3	Newel mounting kit with level base collar, fits 1-3/16" round stainless steel newels, 3-1/4" round base, stainless steel								
V2.	HF16.2.9	Newel mounting kit, fits 1-3/16" round newels, flange cover sold separately. Flange covers: STB, AG, Stainless, Brass								
Handrail Brackets										
W.	HF3002	Handrail bracket, 1-1/4" x 2-3/8" mounting plate, extends out 3" from wall, aluminum Also available in Brushed Chrome HFBC.3002, Polished Brass HFPB.3002		•	•	•	•	•	•	•
X.	HF3003	Handrail bracket, 2-1/16" round mounting plate, extends out 3" from wall, aluminum Also available in Chrome HFCL.3003, Brushed Chrome HFBC.3003, Nickel HFNL.3003, Polished Brass HFPB.3003		•	•	•	•	•	•	•

ACCESSORY PROFILES

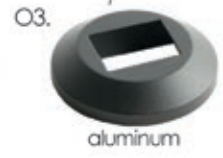
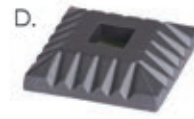

Flange Covers

Use with HF16.2.9
Newel Mounting Kit
Fits 1-3/16" Round Newels
Diameter: 4.13" Height: .7"



- SATIN BLACK
HFSTB16.4.5
- ASH GREY
HFAG16.4.5
- BRASS
HF18.4.5
- STAINLESS STEEL
HF17.4.5

Flange covers
sold separately



- HFSTB-PEN
Satin Black
Touch-up Pen
- HFORB-PEN
Oil Rubbed Bronze
Touch-up Pen

Forged Panels

**House of Forgings
is dedicated to
providing superior
products that meet the
highest standards of
architects,
homebuilders
and homeowners.**

We are pleased to provide a full line of prefabricated ornamental iron components. These elegant products allow for the look and feel of a fully custom fabricated iron stair or railing system. In addition to cost savings, installation time is greatly reduced compared to traditional fabrication.

STAIR & RAILING PRODUCTS BY





Rebecca panels paired with Monte Carlo balusters (shown)

REBECCA



Rebecca HFRB.A1 (shown)

5/8" ROUND IRON



1/2" ROUND IRON

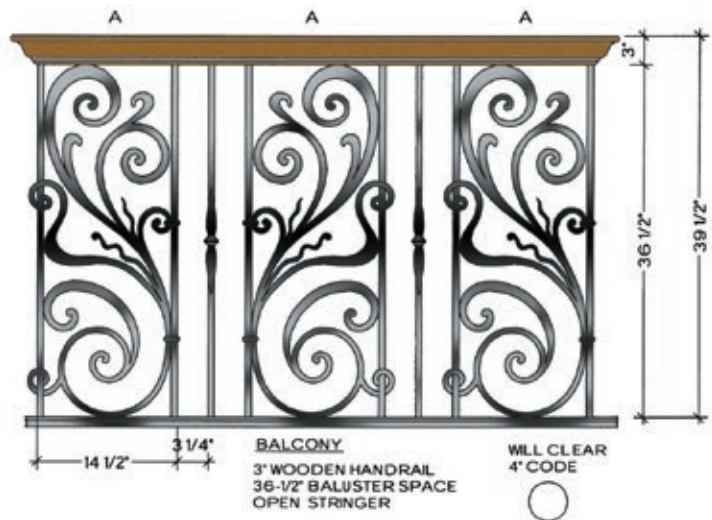
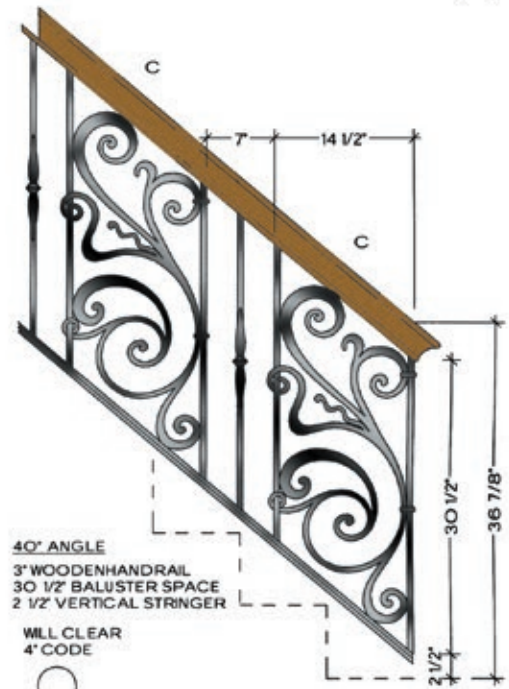
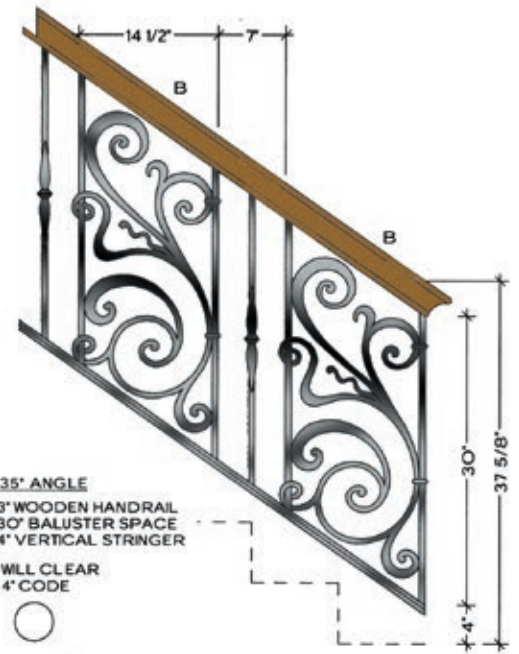

REBECCA

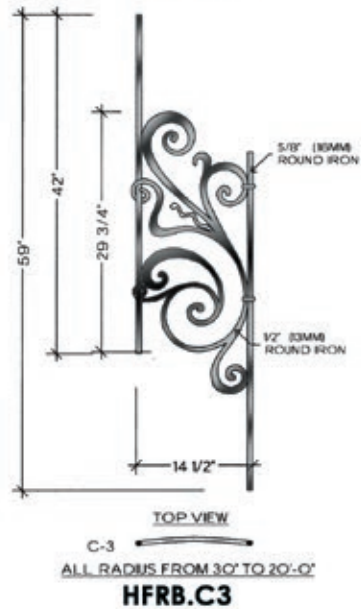
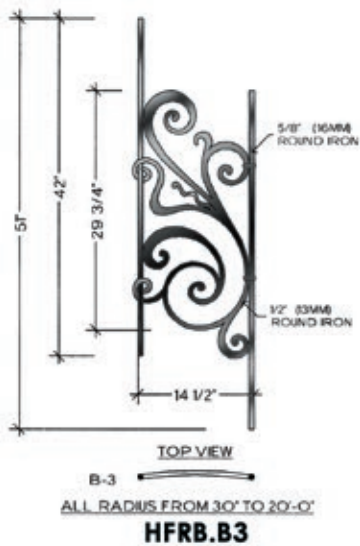
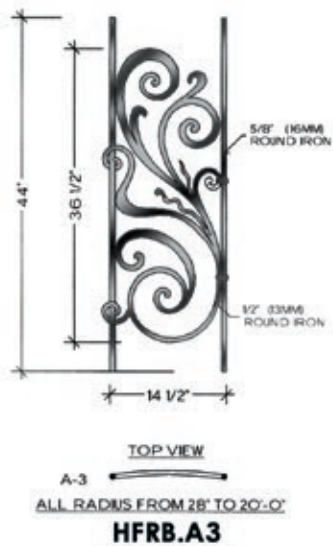
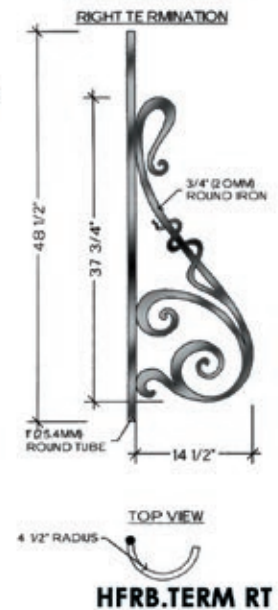
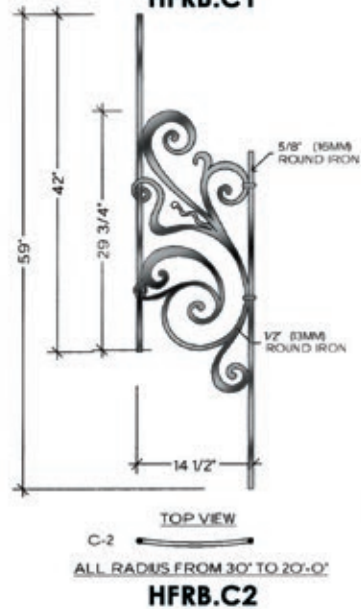
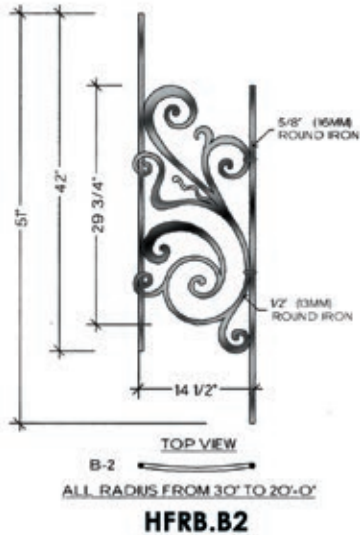
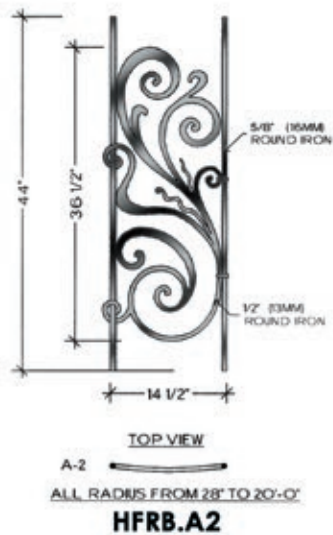
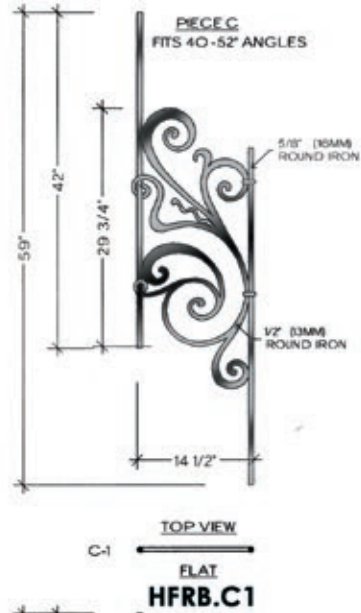
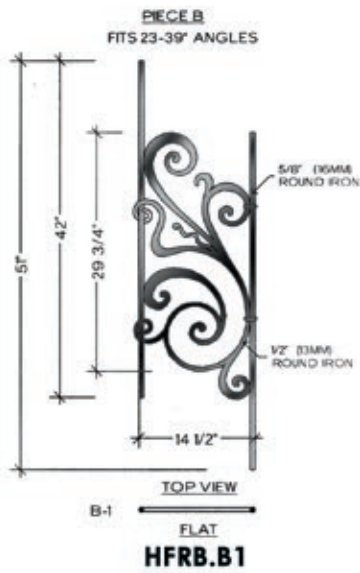
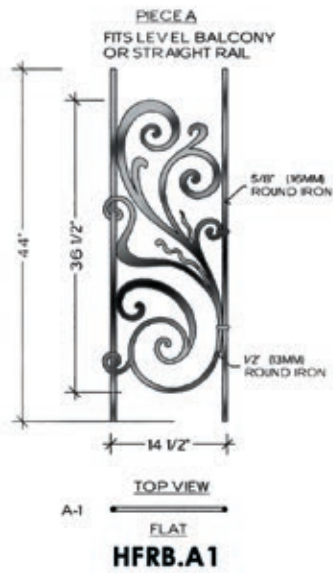

TUSCANY



Tuscany HFTU.A1 (shown)

1/2" SQUARE
IRON

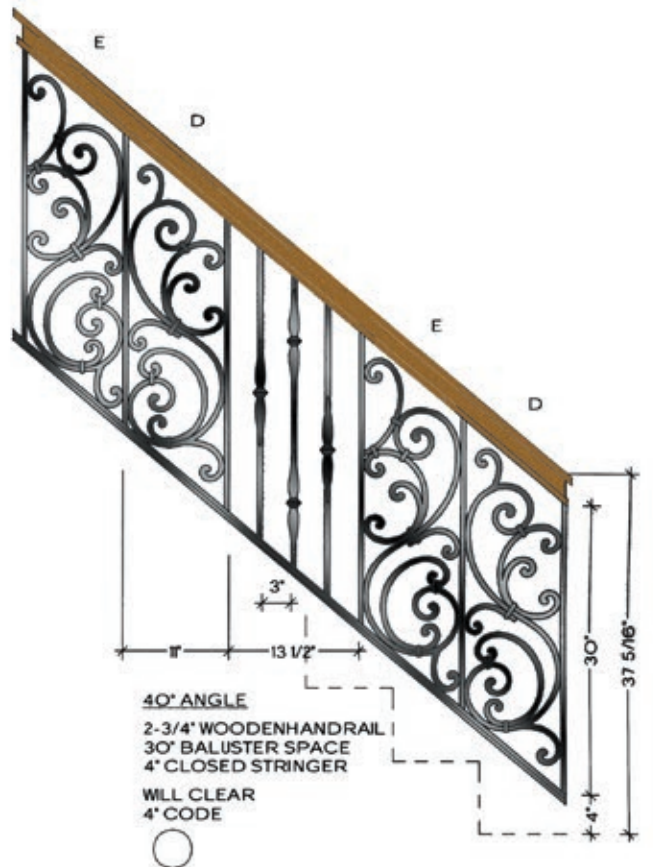
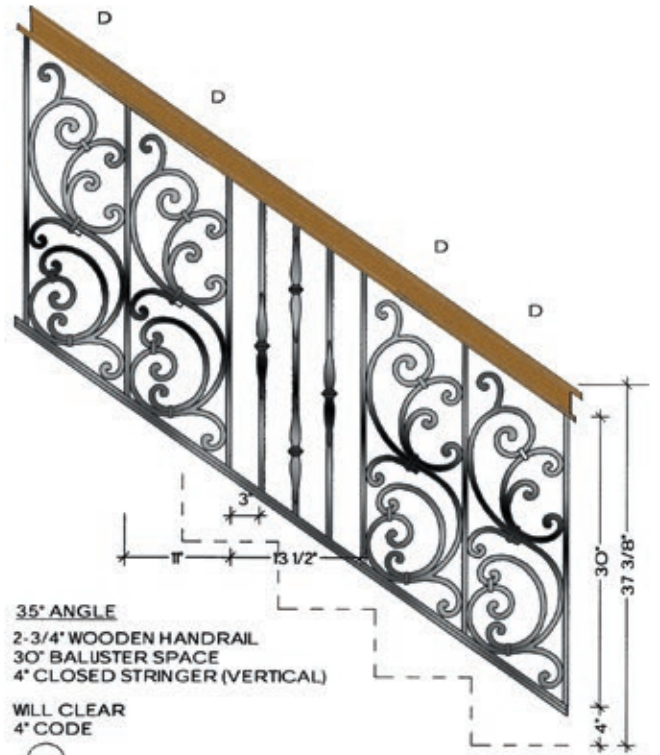

TUSCANY

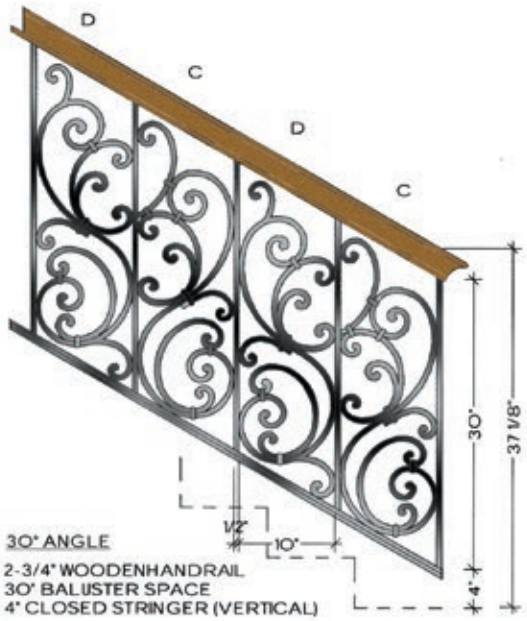

WILL CLEAR
 4" CODE



40° ANGLE

3" WOODEN HANDRAIL
 30" BALUSTER SPACE
 4" CLOSED STRINGER (VERTICAL)
 WILL CLEAR
 4" CODE



RIGHT TERMINATION
 LEFT SIDE VIEW

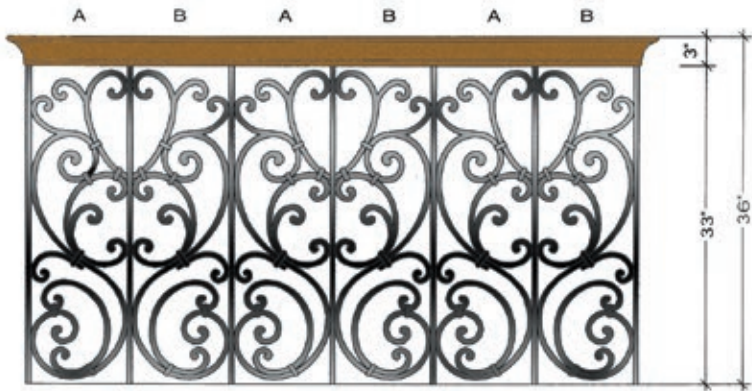

1/2" 10"

BALCONY
 3" WOODEN HANDRAIL
 33" BALUSTER SPACE

WILL CLEAR
 4" CODE

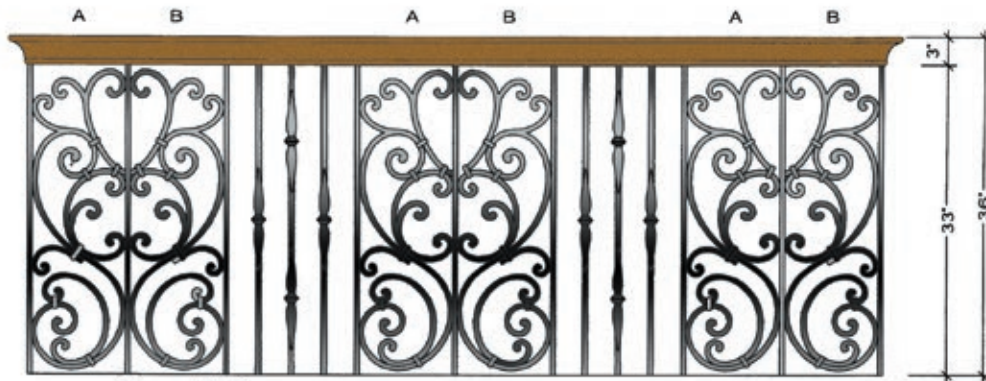

1/2" 10" 1/2" 3"

14 1/2"

BALCONY
 3" WOODEN HANDRAIL
 33" BALUSTER SPACE

WILL CLEAR
 4" CODE



TUSCANY

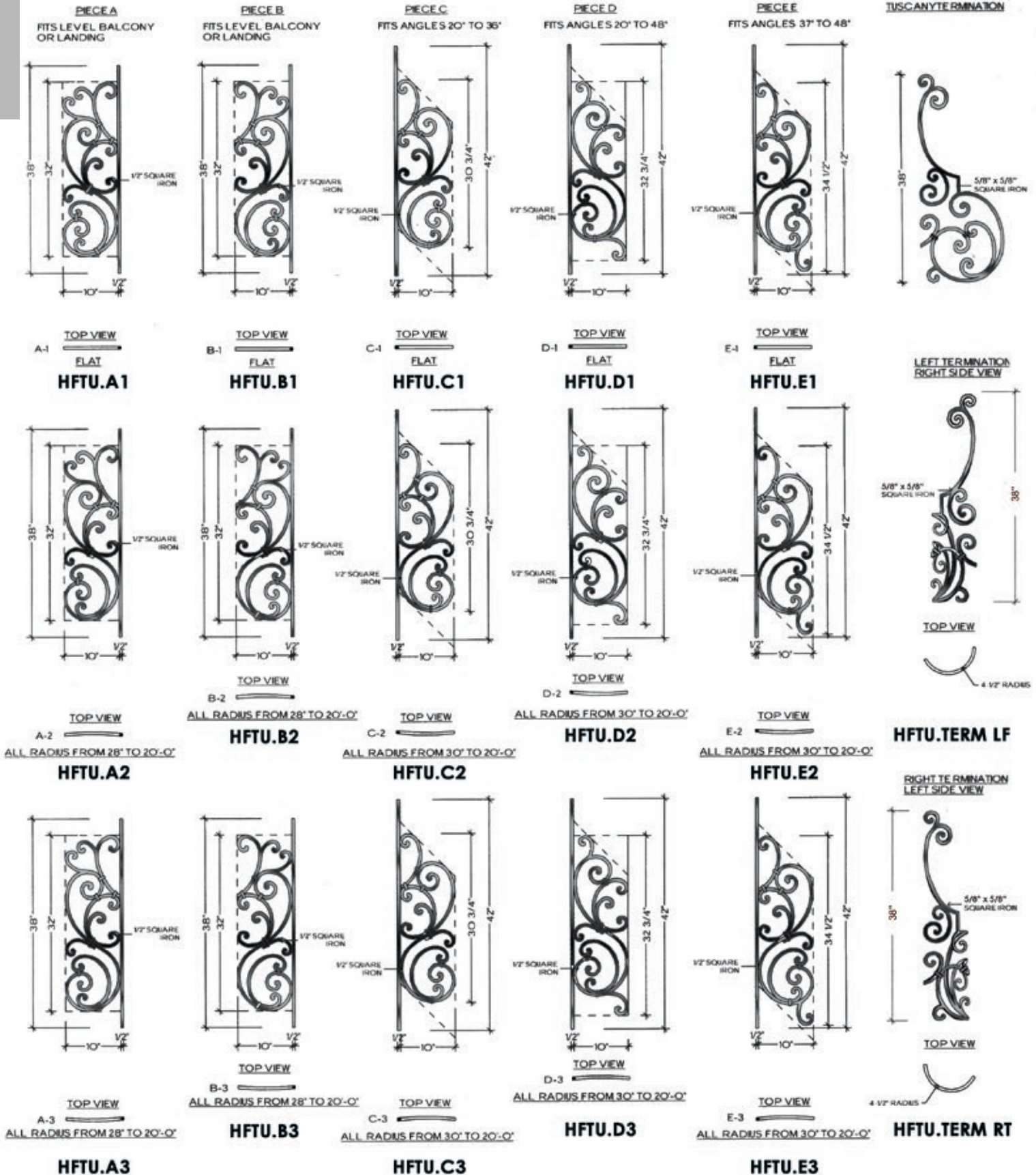



Tuscany panels paired with Gothic balusters (shown)

SEVILLE



Seville HFSE.A1 (shown)

1/2" SQUARE IRON



45° ANGLE
2-1/2" WOODEN HANDRAIL
30" BALUSTER SPACE
4" VERTICAL STRINGER

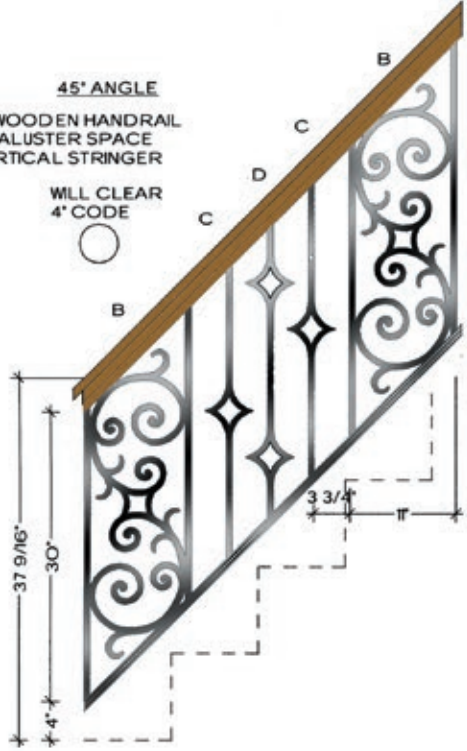

30° ANGLE
3" WOODEN HANDRAIL
30" BALUSTER SPACE
4" VERTICAL STRINGER

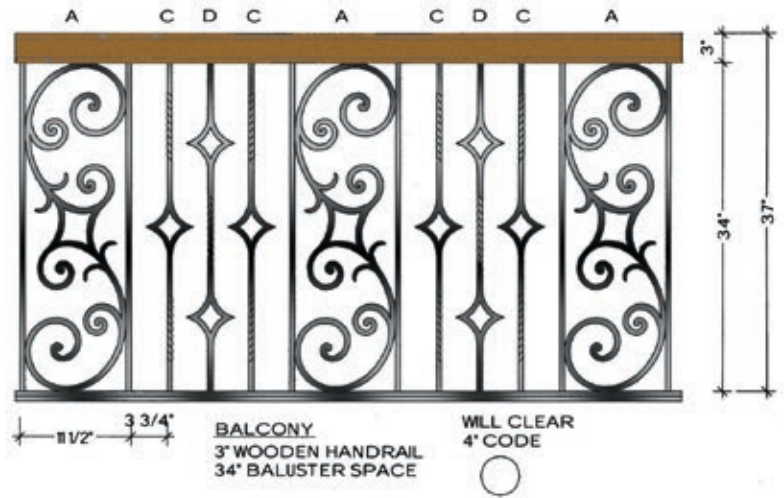
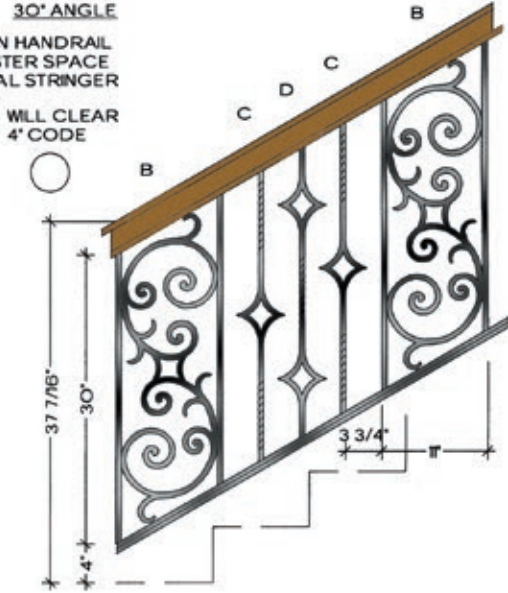

SEVILLE

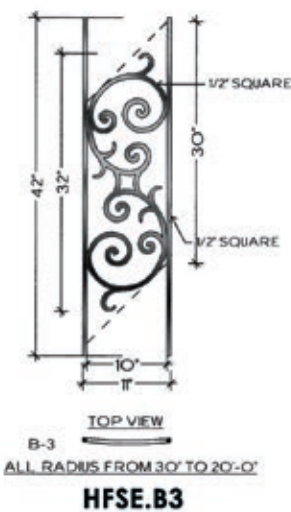
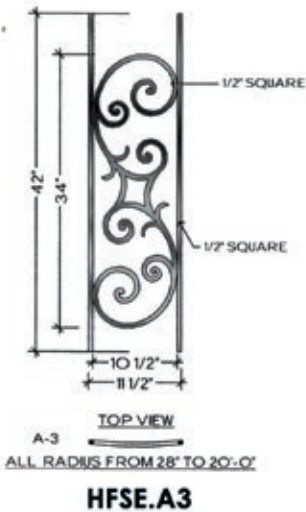
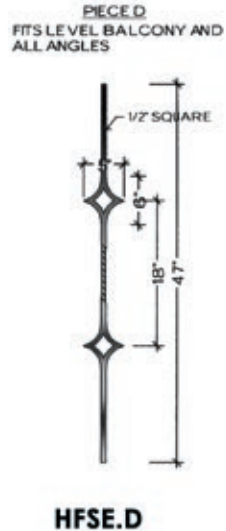
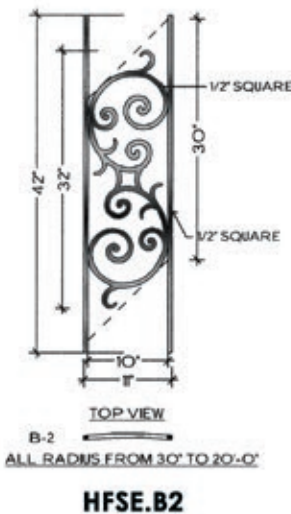
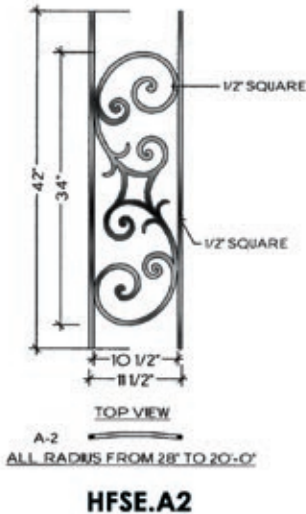
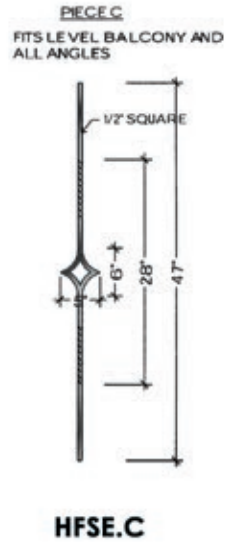
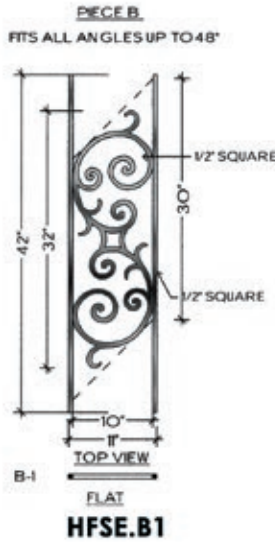
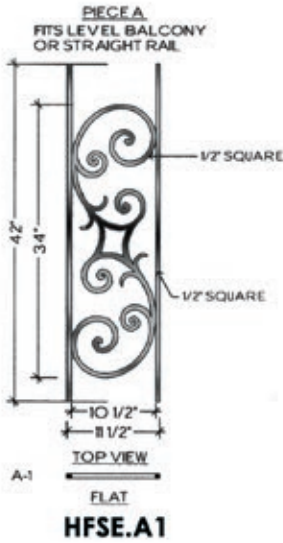

MILANO



Milano HFMO.A1 (shown)

3/4" SQUARE TUBE



1/2" SQUARE IRON

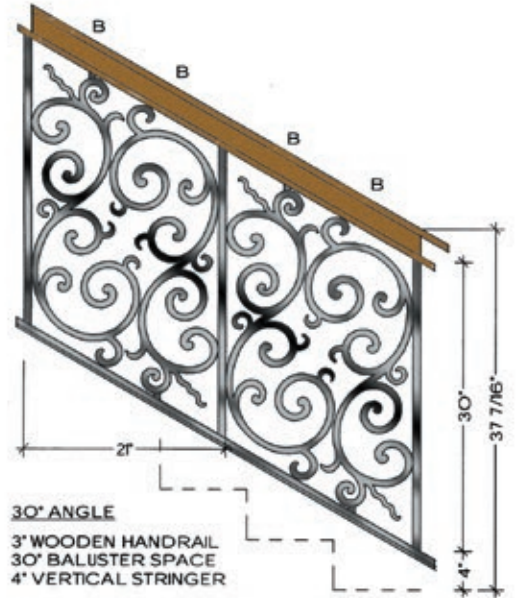

WILL CLEAR 4" CODE

"NOTE: THE MILANO LAYOUT REQUIRES THE REMOVAL OF SOME ATTACHED VERTICALS AND REWELDING SCROLLS TO PREVIOUS VERTICAL"

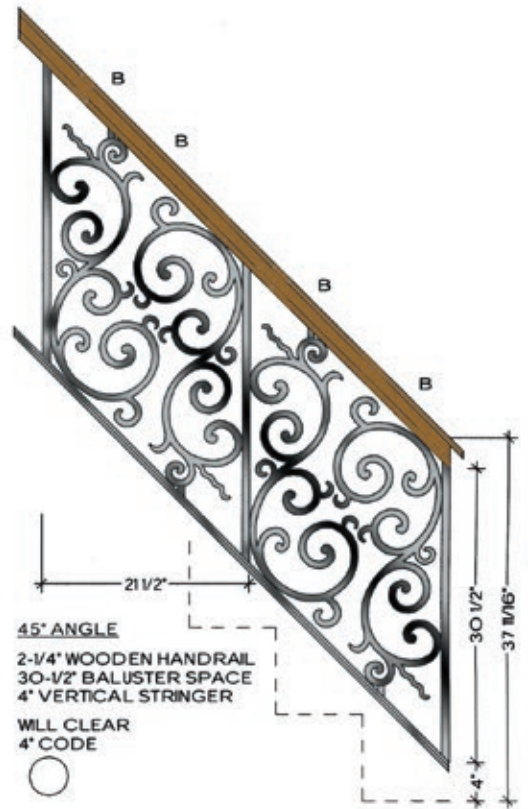

WILL CLEAR 4" CODE

MILANO

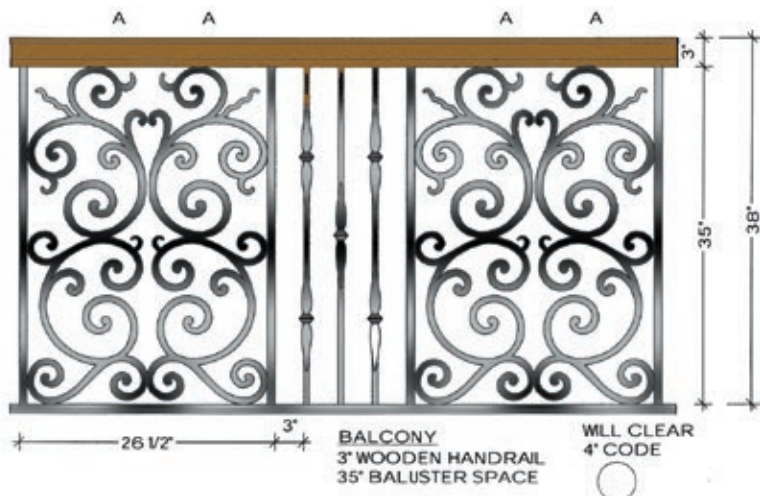
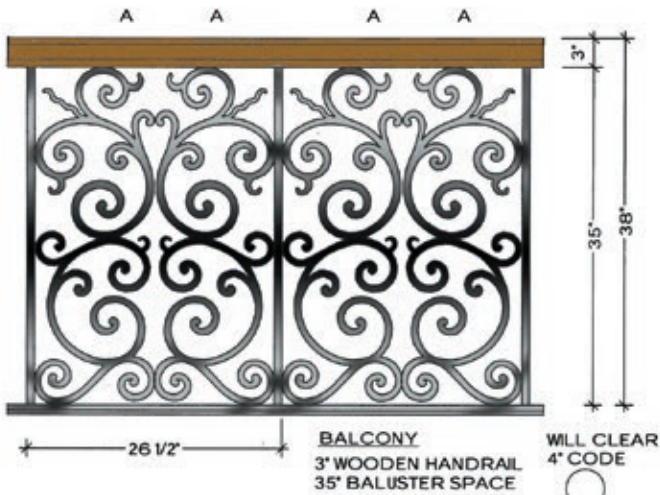
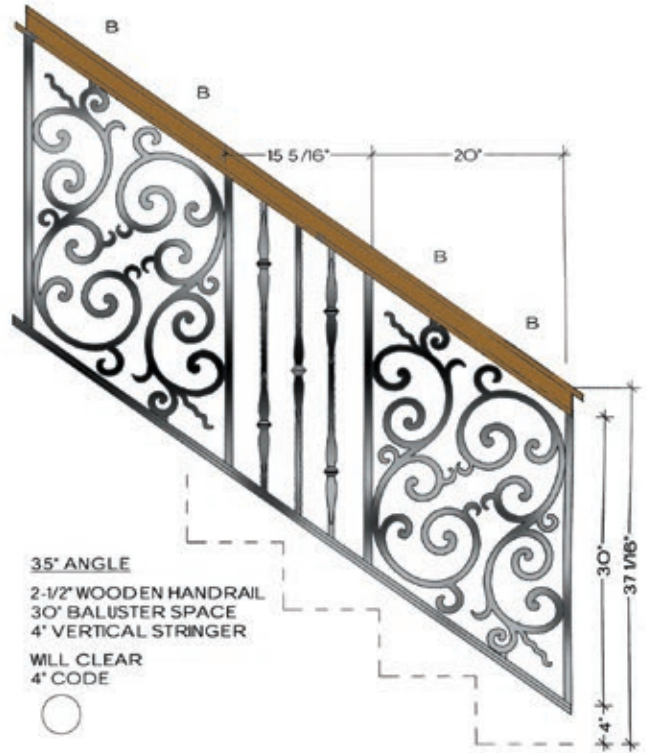
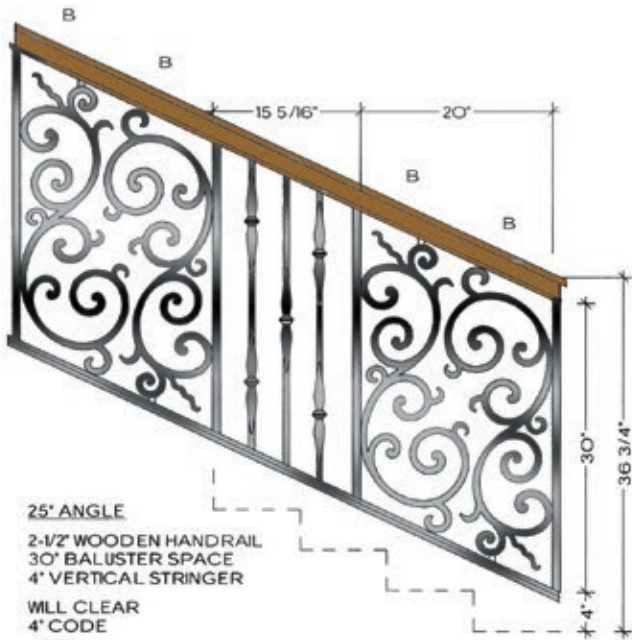

MILANO

PIECE A
FITS LEVEL BALCONY OR LANDING

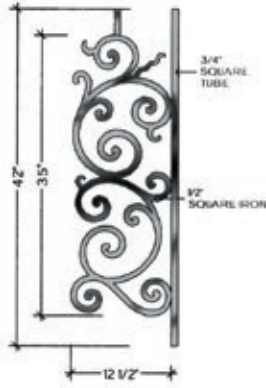

TOP VIEW
A-1
FLAT
HFM0.A1

PIECE B
FITS ALL ANGLES UP TO 48°

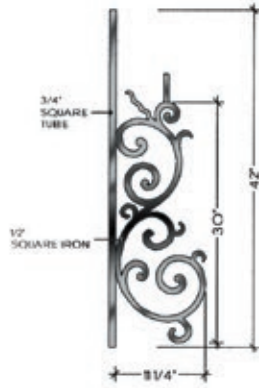

TOP VIEW
B-1
FLAT
HFM0.B1

PIECE B
FITS ALL ANGLES UP TO 48°

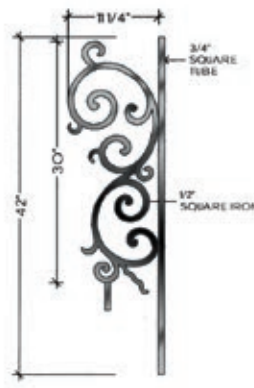

TOP VIEW
B-1
FLAT
HFM0.B1

TERMINATION

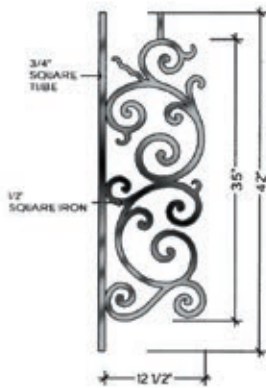
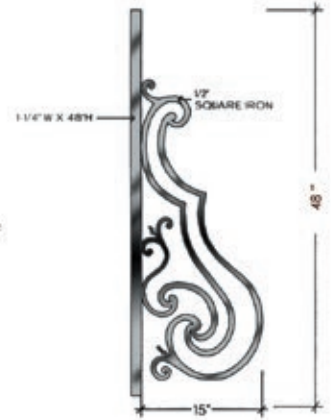

TOP VIEW
A-2
ALL RADII FROM 28" TO 20'-0"
HFM0.A2

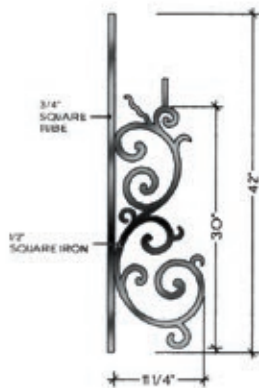

TOP VIEW
B-2
ALL RADII FROM 30" TO 20'-0"
HFM0.B2

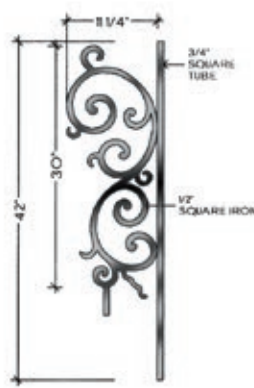

TOP VIEW
B-2
ALL RADII FROM 30" TO 20'-0"
HFM0.B2

LEFT TERMINATION
RIGHT SIDE VIEW



HFM0.TERM LF

RIGHT TERMINATION
LEFT SIDE VIEW

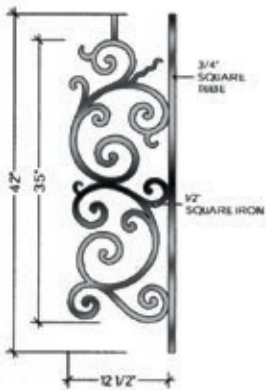

TOP VIEW
A-3
ALL RADII FROM 28" TO 20'-0"
HFM0.A3

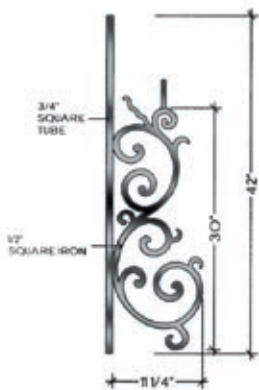

TOP VIEW
B-3
ALL RADII FROM 30" TO 20'-0"
HFM0.B3

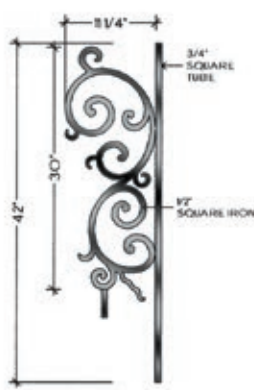

TOP VIEW
B-3
ALL RADII FROM 30" TO 20'-0"
HFM0.B3



HFM0.TERM RT



BORDEAUX



Bordeaux HFBX.A1 (shown)

3/4" SQUARE
TUBE



5/8" SQUARE
IRON

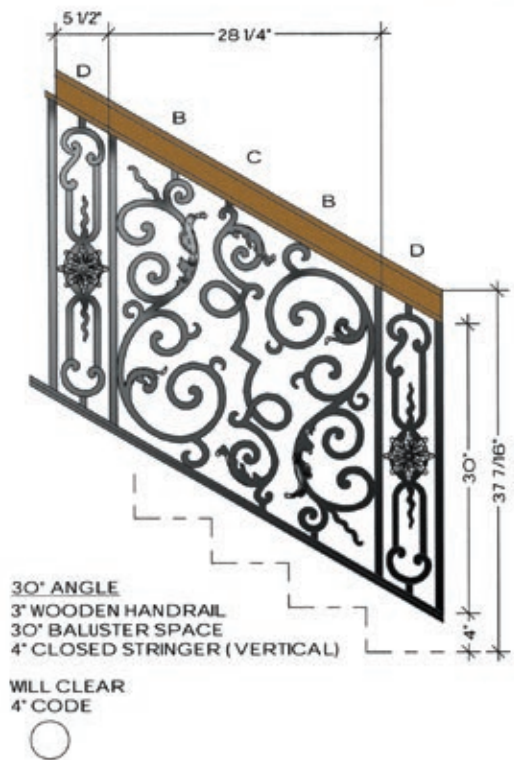
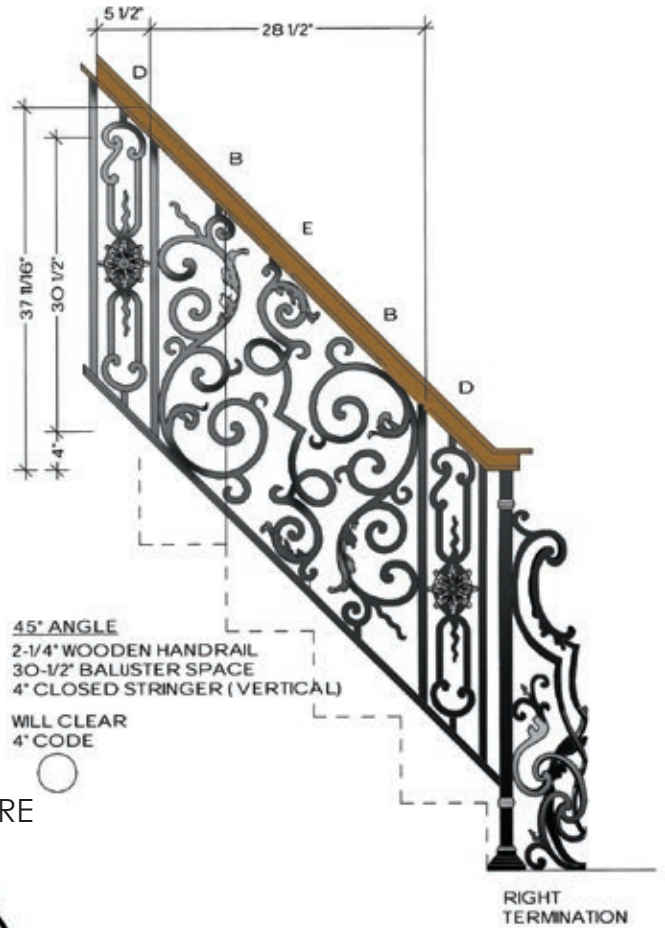

BORDEAUX

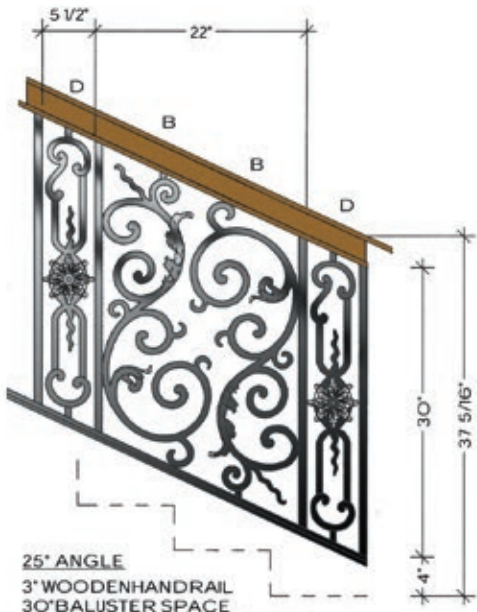

25° ANGLE
 3" WOODEN HANDRAIL
 30" BALUSTER SPACE
 4" CLOSED STRINGER (VERTICAL)

WILL CLEAR
 4" CODE

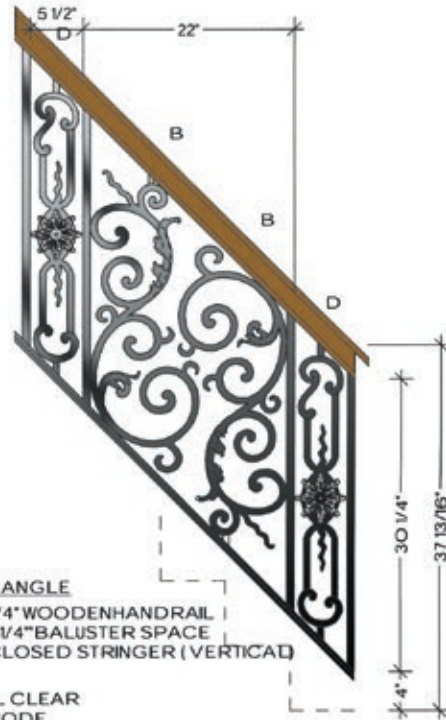

45° ANGLE
 2-3/4" WOODEN HANDRAIL
 30-1/4" BALUSTER SPACE
 4" CLOSED STRINGER (VERTICAL)

WILL CLEAR
 4" CODE

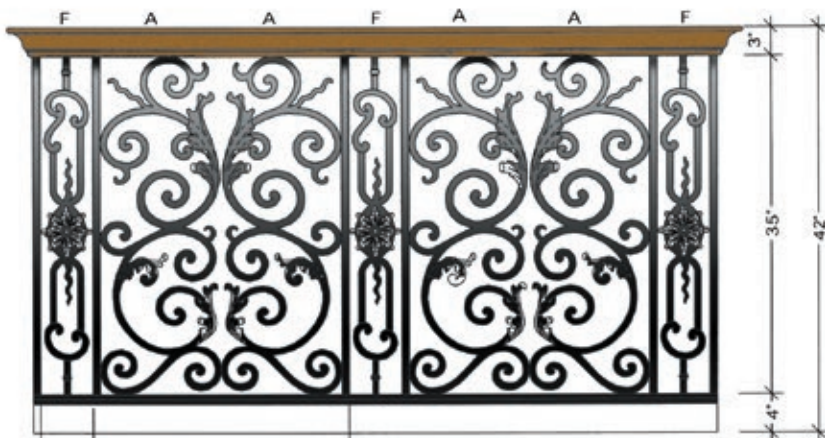

BALCONY
 3" WOODEN HANDRAIL
 35" BALUSTER SPACE
 4" CLOSED STRINGER

WILL CLEAR
 4" CODE



BORDEAUX

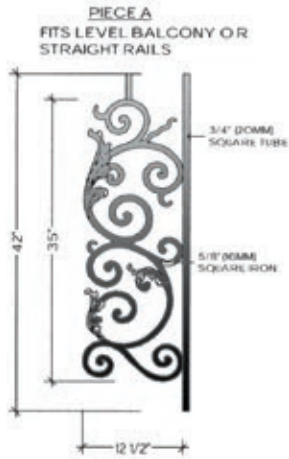

TOP VIEW
A-1
FLAT
HFBX.A1

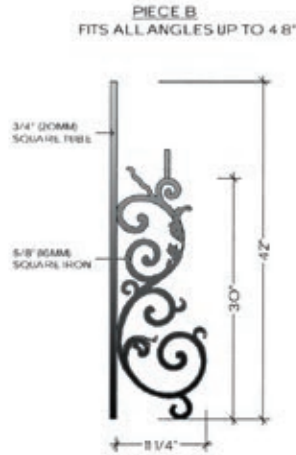

TOP VIEW
B-1
FLAT
HFBX.B1



TOP VIEW
B-1
FLAT
HFBX.B1

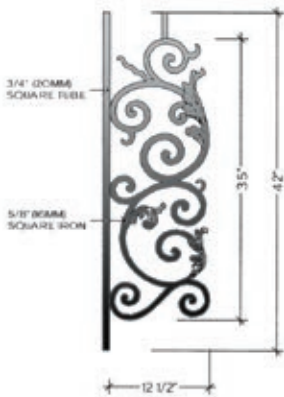

TOP VIEW
A-2
ALL RADIUS FROM 28" TO 20'-0"

HFBX.A2

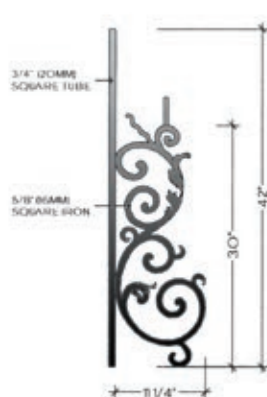

TOP VIEW
B-2
ALL RADIUS FROM 30" TO 20'-0"

HFBX.B2

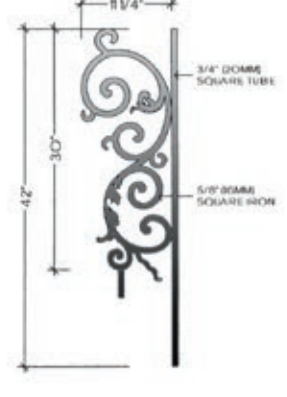

TOP VIEW
B-2
ALL RADIUS FROM 30" TO 20'-0"

HFBX.B2



TOP VIEW
A-3
ALL RADIUS FROM 28" TO 20'-0"

HFBX.A3

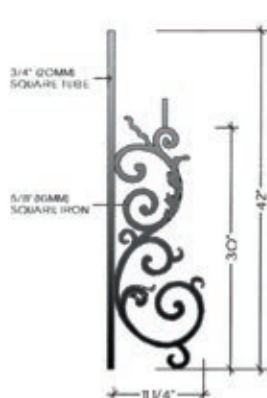

TOP VIEW
B-3
ALL RADIUS FROM 30" TO 20'-0"

HFBX.B3

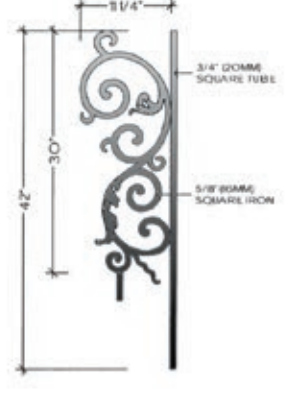

TOP VIEW
B-3
ALL RADIUS FROM 30" TO 20'-0"

HFBX.B3

BORDEAUX

PIECE C
FITS ONLY INCLINE ANGLES BELOW 40°

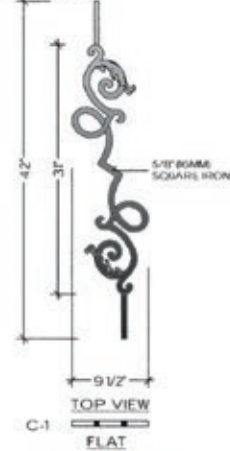

HFBX.C1

PIECE D
FITS ALL ANGLES



HFBX.D

PIECE E
FITS ONLY ANGLES ABOVE 40°

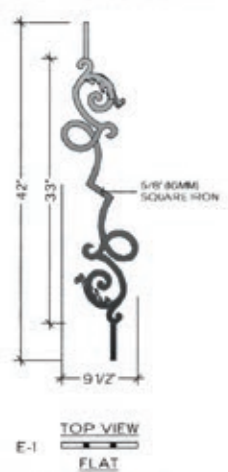

HFBX.E1

RIGHT TERMINATION
INSIDE VIEW

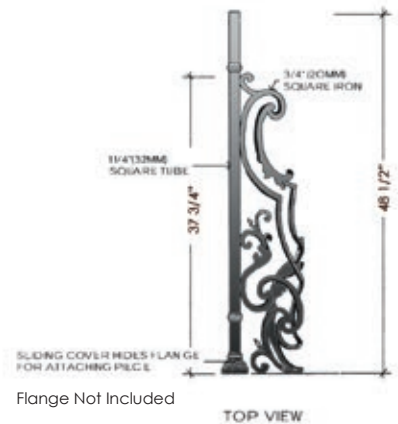

Flange Not Included

TOP VIEW



HFBX.TERM RT

LEFT TERMINATION
INSIDE VIEW

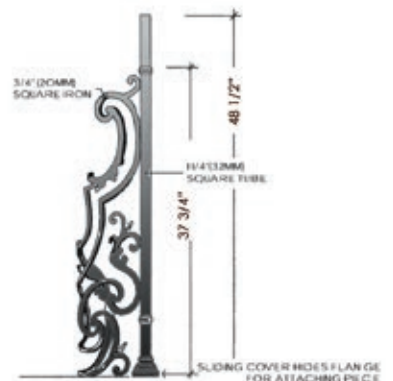

Flange Not Included

TOP VIEW



HFBX.TERM LF

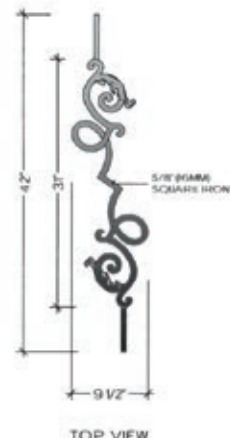

HFBX.C2

ALL RADIUS FROM 30° TO 20°-0'

PIECE F
FITS LEVEL BALCONY OR STRAIGHT RAIL

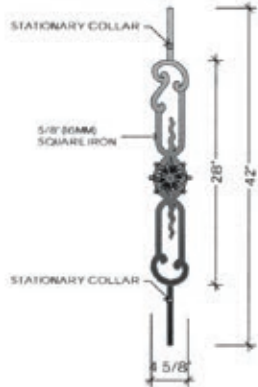

HFBX.F

TOP VIEW

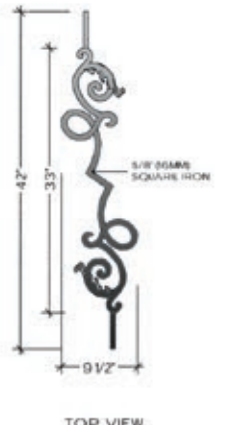

HFBX.E2

ALL RADIUS FROM 30° TO 20°-0'

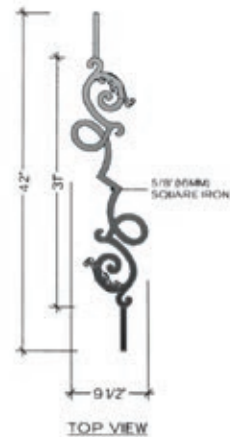

HFBX.C3

ALL RADIUS FROM 30° TO 20°-0'

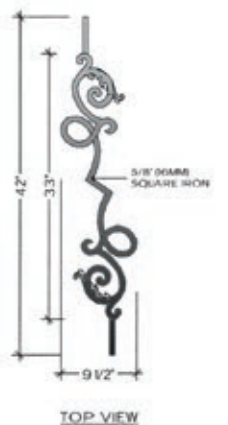

HFBX.E3

ALL RADIUS FROM 30° TO 20°-0'

REGENCY



Regency HFREA1 (shown)

1" SQUARE TUBE



3/8" X 1" FLAT IRON

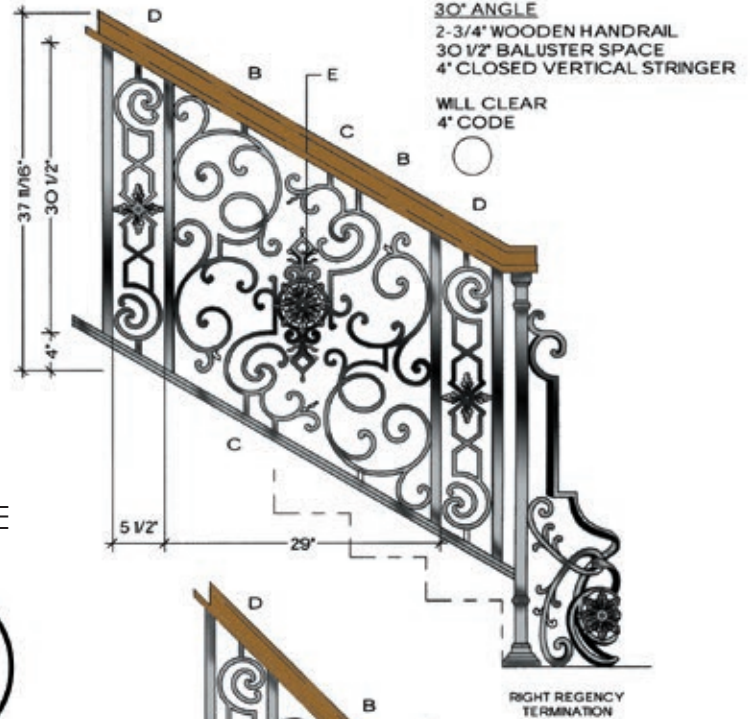

RIGHT REGENCY TERMINATION

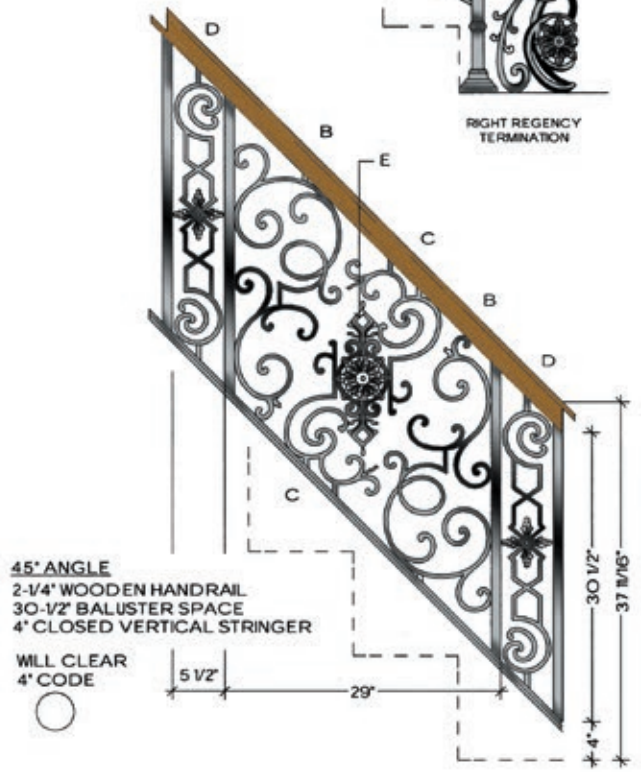

45° ANGLE
2-3/4" WOODEN HANDRAIL
30-1/2" BALUSTER SPACE
4" CLOSED VERTICAL STRINGER

WILL CLEAR 4" CODE

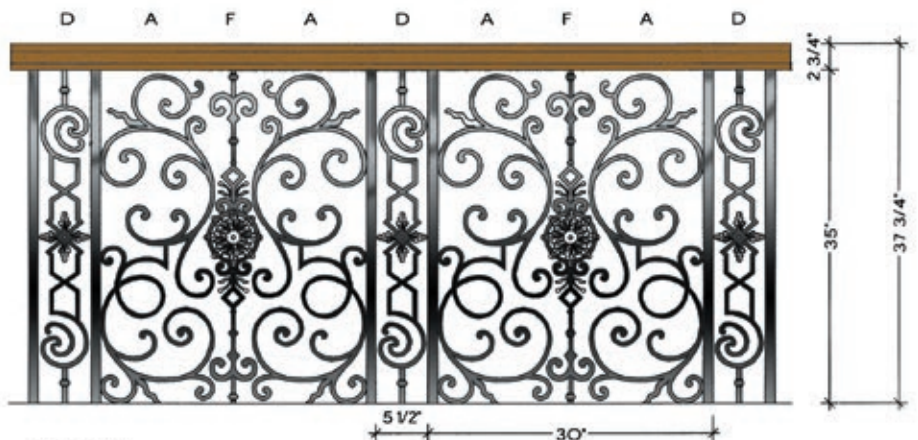

BALCONY

2 3/4" WOODEN HANDRAIL
35" BALUSTER SPACE

WILL CLEAR 4" CODE

REGENCY

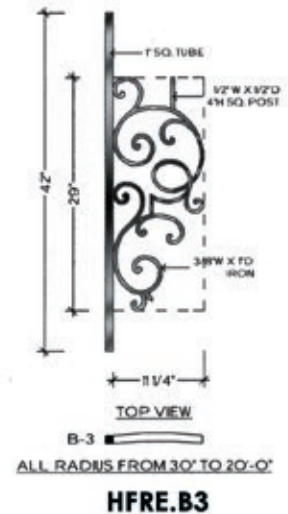
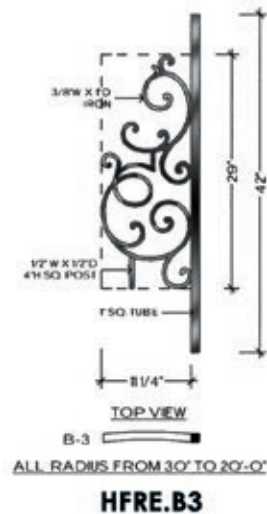
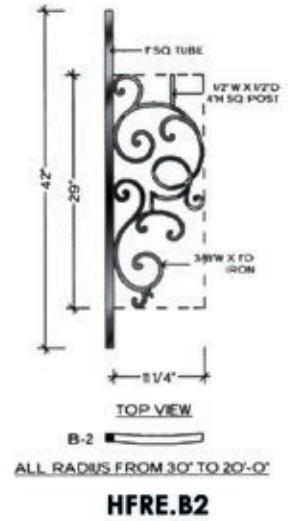
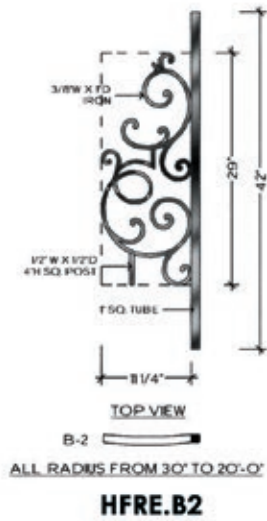
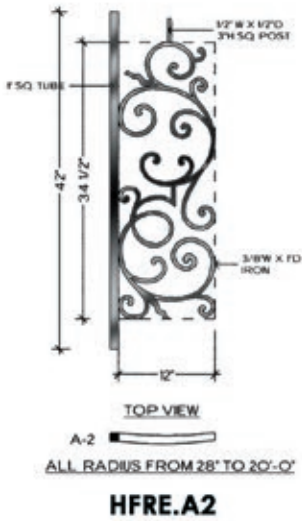
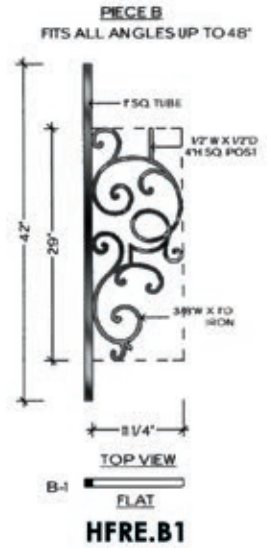
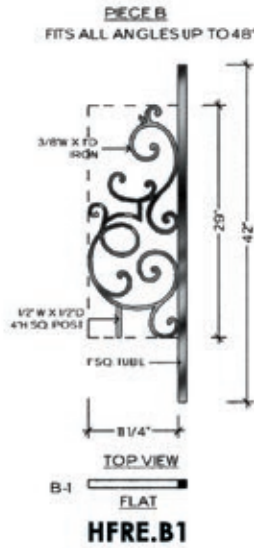
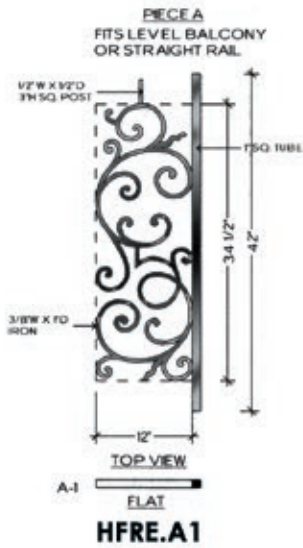

REGENCY

PIECE C
FITS ALL ANGLES UP TO 48°

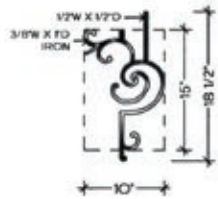

TOP VIEW
FLAT

HFRE.C1

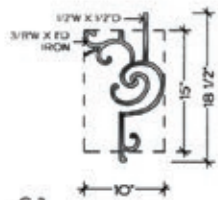

TOP VIEW
FLAT

HFRE.C2

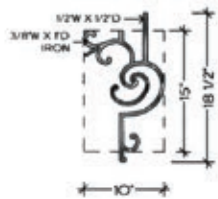

TOP VIEW
FLAT

HFRE.C3

PIECE D
FITS ALL ANGLES & LEVEL BALCONY



TOP VIEW
FLAT

HFRE.D

PIECE C
FITS ALL ANGLES UP TO 48°

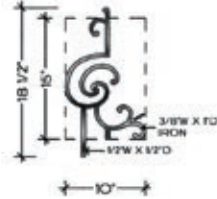

TOP VIEW
FLAT

HFRE.C1

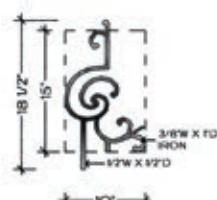

TOP VIEW
FLAT

HFRE.C2

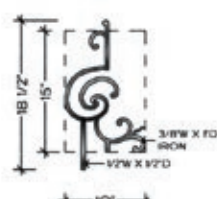

TOP VIEW
FLAT

HFRE.C3

PIECE E
FITS ALL ANGLES

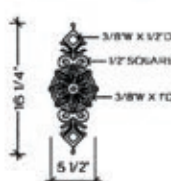

HFRE.E

LEFT SIDE TERMINATION
RIGHT SIDE VIEW

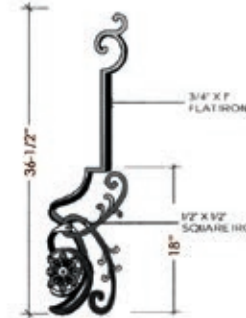

HFRE.TERM LF

RIGHT SIDE TERMINATION
LEFT SIDE VIEW

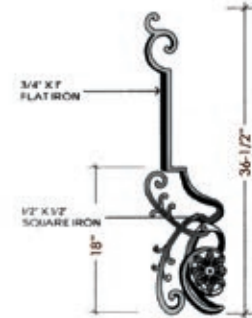

HFRE.TERM RT

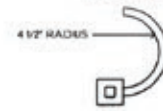
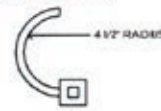

TERMINATION



PIECE F
FITS LEVEL BALCONY OR STRAIGHT RAIL

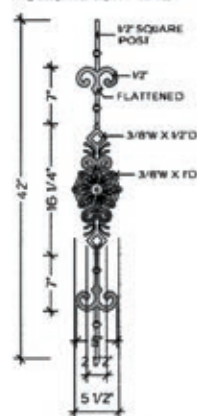

TOP VIEW
FLAT

HFRE.F



U.S. Pat.
No. 5,820,111
No. 6,059,269

Regency panels (shown)

Regency[©]

Wood Products

At House of Forgings we provide much more than just forged iron products, we boast an extensive line of wood components as well.

From handrails to treads, we carry virtually all components necessary to create the staircase or balcony you have envisioned. All products are stocked in the most popular domestic species, ready for immediate shipping.

Components are packaged and shipped with the utmost integrity ensuring that your order will arrive on time and undamaged.

STAIR & RAILING PRODUCTS BY

 **HOUSE OF FORGINGS**



Magnolia newels (RO-4040) paired with Aalto balusters in Satin Black (HFSTB 16.6.3) (shown)



FORESTKRAFT™

WOOD STAIR & RAILING PRODUCTS



Red Oak

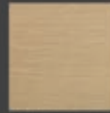

White Oak

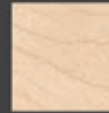

Maple



Poplar

Box Newels Non removable caps



Modern
Box Newel
Small
4400
Ht. 56"
W = 3-1/4"
SOLID



Modern
Box Newel
Large
5400
Ht. 56"
W = 5-1/2"
SOLID



Shown with
optional base
4-1/2" x 21-3/4"
(sold separately)
BASE-4000



Shown with
optional base
6-1/2" x 21-3/4"
(sold separately)
BASE-5000

Routed Newels Non removable caps



Modern
Routed Newel
4900
Ht. 56"
W = 3-1/4"
SOLID



Modern
Routed Newel
5900
Ht. 56"
W = 5-1/2"
SOLID



Shown with
optional base
4-1/2" x 21-3/4"
(sold separately)
BASE-4000



Shown with
optional base
6-1/2" x 21-3/4"
(sold separately)
BASE-5000

Blank Newel Caps

Available for: 3-1/4" and 5-1/2" blank newels
Sold separately



3-1/4" Square Newels	SQUARE-CAP-4000 HT. 1-3/4" W= 3-1/4"	PYRAMID-CAP-4000 HT. 1-9/16" W= 3-1/4"	STACKED-CAP-4000 HT. 2-1/4" W= 3-1/4"	COVE-CAP-4000 HT. 2-1/2" W= 4-5/8"
5-1/2" Square Newels	SQUARE-CAP-5000 HT. 2" W= 5-1/2"	PYRAMID-CAP-5000 HT. 1-5/8" W= 5-1/2"	STACKED-CAP-5000 HT. 2-3/4" W= 5-1/2"	COVE-CAP-5000 HT. 2-7/8" W= 6-7/8"

Newel Bases



Blank Newels



Red Oak 5000 blank newel with COVE CAP-5000 (shown)

Blank Newel Options: Caps / Bases

3-1/4" and 5-1/2" blank newels, shown with optional bases and caps - sold separately
Additional configuration options available.



Call for additional species availability.

BLANKS



4007
HT. 54"
W = 3-1/4"



Prefinished white
4923-41
HT. 41"
W = 1-3/4"
***4913-41**
HT. 41"
W = 1-1/4"
* SPECIAL ORDER IN RED OAK

**We stock additional wood parts in our
Conover, North Carolina Distribution Center!**

View or download
The North Carolina In-Stock Product Catalog
houseofforgings.net/north-carolina-warehouse

CLASSIC



5140
HT. 48"
W = 3-1/4"



4140-SP
HT. 48"
W = 3"
STABILIZER
NEWEL



5160
HT. 54"
W = 3-1/4"



5170
HT. 54"
W = 3-1/4"

CLASSIC



Prefinished white
4121-41
HT. 41"
W = 1-1/4"

* SPECIAL ORDER



Prefinished white
4120-41
HT. 41"
W = 1-3/4"



Prefinished white
4220-41
HT. 41"
W = 2-1/4"

*SPECIAL ORDER



Prefinished white
5067-36
HT. 36"
W = 1-1/4"
5067-39
HT. 39"
W = 1-1/4"
5067-41
HT. 41"
W = 1-1/4"

All newels stocked in Red Oak (RO), all balusters stocked in prefinished white (PG) - Call for additional species availability.

MAGNOLIA



CONCORD



REMINGTON



Wood Products

Our wood products are stocked in the most popular domestic species.



Domestic and Exotic Wood Species

All wood products in non-stock species are available by special order.





BOX NEWELS



Contemporary Box Newel
4191
HT. 56"
W = 3-1/4"
SOLID



Contemporary Stabilizer Newel
4191-SP
HT. 43"
W = 3"
SOLID



Stabilizer newels are pre drilled 1/2" x 2-1/8" (7/16" x 3" dowel included)



Plain Box Newel
961-56
HT. 56"
W = 4-1/2"
SOLID



Recessed Panel Box Newel
4291
HT. 56"
W = 6"
HOLLOW



All box newels come with both square and pyramid tops

BOX NEWELS

removable



Adjustable Box Newel
4592
HT. 56"
W = 5"
SOLID



Plain Newel
4592-PLAIN
HT. 56"
W = 3-1/2"
SOLID



Stabilizer Newel
4592-SP
HT. 43"
W = 3"



Stabilizer newels are pre drilled 1/2" x 2-1/8" (7/16" x 3" dowel included)



Fixed Box Newel
4691
HT. 56"
W = 6-1/4"
HOLLOW



Raised Panel Box Newel
4791
HT. 56"
W = 6-1/4"
HOLLOW



Fluted Box Newel
4891
HT. 56"
W = 6-1/4"
HOLLOW



Recessed Panel Box Newel
4991
HT. 56"
W = 6-1/4"
HOLLOW

All box newels stocked in Red Oak (RO) and White Oak (WO) - Call for additional species availability.



RO-4691 Box Newel and 4923-41 Balusters (shown)



RO-4191 Box Newels paired with Versatile balusters (shown)



RO-4291 Box Newels paired with Versatile balusters (shown)

HANDRAIL & FITTINGS

6040



6040
Round Wall Rail
Diameter: 1-5/8"

RETURNED END



7009
7209

6010



Colonial Hand Rail
HT. 2-3/8"
W. 2-1/4"



6010 Straight Rail
6010-B Bending Rail
bending rail includes moulding

6210



Traditional Hand Rail
HT. 2-3/8"
W. 2-5/8"



6210 Straight Rail
6210-B Bending Rail
bending rail includes moulding

OPENING CAP



7019
7219

6084



Modern Hand Rail
HT. 1-5/8"
W. 2-5/8"



6084 Straight Rail
6084-B Bending Rail

TANDEM CAP



7020
7220

6284

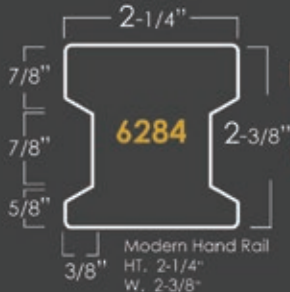

Modern Hand Rail
HT. 2-1/4"
W. 2-3/8"



6284 Straight Rail
no fittings available

OVER EASING



7013
7213
7413

6484

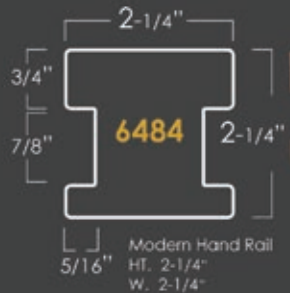

Modern Hand Rail
HT. 2-1/4"
W. 2-1/4"



6484 Straight Rail
no fittings available

UP EASING



7012
7212
7412

90 DEGREE



7014
7214

6002



Modern Hand Rail
HT. 1-5/8"
W. 2-3/4"

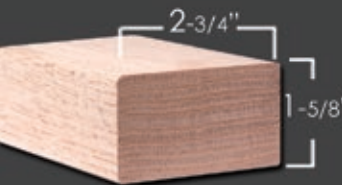

6002 Straight Rail
6002-B Bending Rail
no fittings available

START EASING WITH CAP



7010
7210
7410

6060



Modern Hand Rail
HT. 1-1/16"
W. 2"



6060 Straight Rail
no fittings available



TREADS/STEPS/LUMBER/PLY

SQUARE TREADS



Overall length does not include mitered return

TREADS

8070

Bull Nose Tread
1-1/16" x 11-1/2" x 42, 48, 54,
60, 72, 84, 96"



8070-42-SQ 11-1/2" X 42" OVERALL
8070-54-SQ 11-1/2" X 54" OVERALL
8070-60-SQ 11-1/2" X 60" OVERALL

Single Mitered Return
RED OAK 8070-48-MR-SQ 11-1/2" X 48" OVERALL
RED OAK 8070-54-MR-SQ 11-1/2" X 54" OVERALL
Double Mitered Return
WHITE OAK 8070-48-MR-SQ 11-1/2" X 48" OVERALL
WHITE OAK 8070-54-MR-SQ 11-1/2" X 54" OVERALL

CLASSIC TREADS

8070-13 x

Bull Nose Tread
1-1/16" x 13" x 48, 54, 60, 72, 84, 96"

8070-18 x

Bull Nose Tread
1-1/16" x 18" x 48, 54, 60, 72, 84"

8070-20 x 60

Bull Nose Tread
1-1/16" x 20" x 60"

8070-20 x 72

Bull Nose Tread
1-1/16" x 20" x 72"

8070-24 x

Bull Nose Tread
1-1/16" x 24" x 60", 72", 84", 96", 120"

8070-48 x 48

Bull Nose Tread
1-1/16" x 48" x 48"

8070-60 x 60

Bull Nose Tread
1-1/16" x 60" x 60"

8070-48-MR

1-1/16" x 11-1/2" x 48"

8070-54-MR

1-1/16" x 11-1/2" x 54"

8070-60-MR

1-1/16" x 11-1/2" x 60"

Mitered Return(MR) (Reversible)
Overall length includes mitered return



BULL NOSED LANDING TREAD

8090-6

STRAIGHT

8090-6B

BENDING(26 pieces)

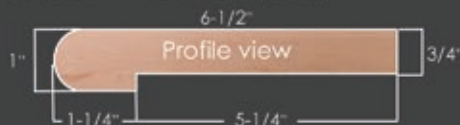

TONGUE & GROOVED BULL NOSED LANDING TREAD

8090-6-G

STRAIGHT(grooved)



TONGUE & GROOVED LUMBER

8095-8-T&G

STRAIGHT (tongue & grooved)

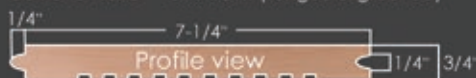

8095-12-T&G

STRAIGHT (tongue & grooved)



1" BULL NOSING

8080

STRAIGHT

8080-B

BENDING

(5 pieces)



REMODEL TREAD WITH RISER KIT

TREAD

Bull Nose Tread with Cove
1 1/16" x 10-1/2" x 42, 54, 60"

RISER

Riser
5/8" x 7-1/2" x 42, 54, 60"

RETRO-42

RETRO-54

RETRO-60



REMODEL RETURN TREAD WITH RISER KIT

TREAD

Bull Nose Tread with Cove
1 1/16" x 10-1/2" x 48, 54, 60"

RISER

Riser
5/8" x 7-1/2" x 48, 54, 60"

RETRO-48MR

RETRO-54MR

RETRO-60MR



Reversible riser material for stain or paint.



No mitered return



Mitered return on
left and right



Mitered return on right



Mitered return on left

MODERN REMODEL TREAD & RISER KITS

- Get the look of thick block style treads at a fraction of the price!
- Replace old carpeted stairs
- Can be used on new construction

REMODEL TREAD WITH RISER KIT

TREAD 2-1/8" Oak Tread w/roundover
11/16" x 10-1/2" x 42, 54, 60"

RISER Oak Riser
5/8" x 7-1/2" x 42, 54, 60"



Reversible riser material for stain or paint.



MODERN-RETRO-42
MODERN-RETRO-54
MODERN-RETRO-60



RED OAK
WHITE OAK

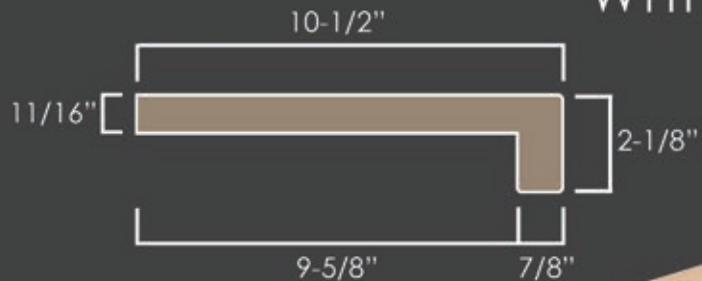

REMODEL RETURN TREAD WITH RISER KIT

TREAD 2-1/8" Oak Tread w/roundover
Mitered return on both ends
11/16" x 10-1/2" x 48, 54, 60"

RISER Oak Riser
5/8" x 7-1/2" x 48, 54, 60"



Mitered return on left and right

Mitered return on right

Mitered return on left

MODERN-RETRO-42MR
MODERN-RETRO-48MR
MODERN-RETRO-54MR
MODERN-RETRO-60MR

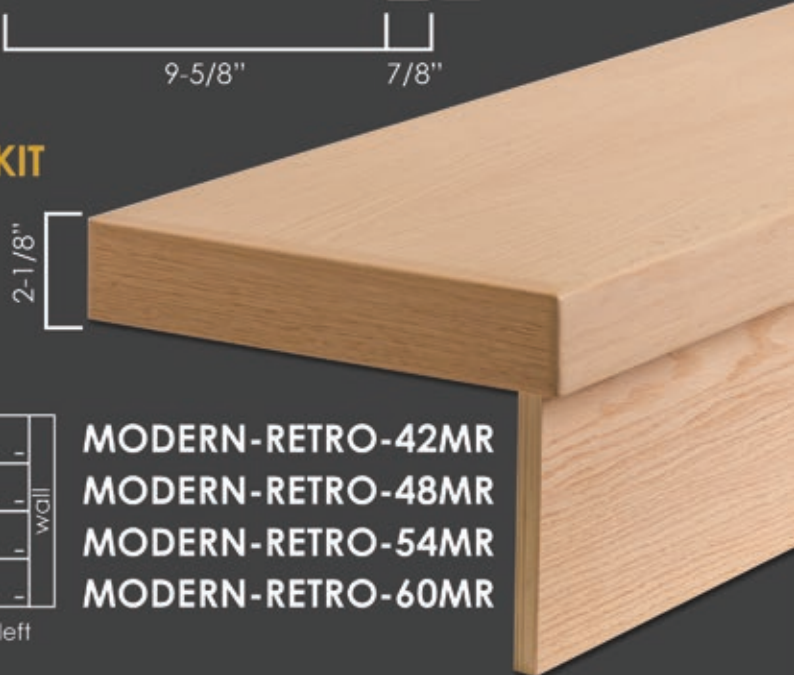

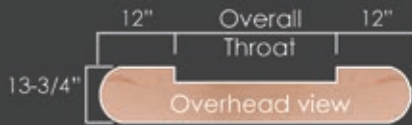

DOUBLE END STARTING STEP

Diameter: 13-3/4"
8015-48 (48" throat) (72" overall)
8015-54 (54" throat) (78" overall)
8015-60 (60" throat) (84" overall)

Comes with:
 1" Thick Tread,
 6-3/4" Tall Riser
 Cove & Quarter Round Moulding

STARTER STEP VENEER

Width: 8"
 Length: 120"
RO-VENEER (Red Oak)



SINGLE END STARTING STEP

Diameter: 13-3/4"
8010-48 (48" throat) (60" overall)
8010-60 (60" throat) (72" overall)
8010-72 (72" throat) (84" overall)

Comes with:
 1" Thick Tread,
 6-3/4" Tall Riser
 Cove & Quarter Round Moulding



SPECIAL WEDGE SHAPED DOUBLE END STARTING STEP

Diameter: 12-3/4" (small end)
 Diameter: 18-1/2" (large end)
8915-48 (48" throat) (73-1/2" overall)
8915-54 (54" throat) (79-1/2" overall)
 (Reversible)

Comes with:
 1" Thick Tread,
 6-3/4" Tall Riser
 Cove & Quarter Round Moulding

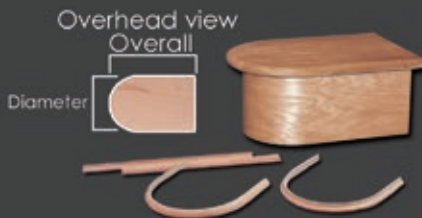

FALSE END STARTING STEP

Diameter: 13-3/4" Diameter: 17-1/2"
 Length: 17-5/8" overall Length: 21-3/4" overall
8011 **8012**

Comes with:
 1" Thick Tread,
 6-3/4" Tall Riser
 Cove & Quarter Round Moulding

PLYWOOD

PLY-1/4-MDF	MDF 1/4" x 4' x 8'	Half Sheet 1/4" x 2' x 8'
PLY-3/4-MDF	MDF 3/4" x 4' x 8'	
PLY-1/8-RO	Red Oak 1/8" x 4' x 8'	Half Sheet 1/4" x 2' x 8'
PLY-1/4-RO	Red Oak 1/4" x 4' x 8'	Half Sheet 1/4" x 2' x 8'
PLY-1/2-RO	Red Oak 1/2" x 4' x 8'	
PLY-3/4-RO	Red Oak 3/4" x 4' x 8'	
PLY-1/8-Birch	Birch 1/8" x 4' x 8'	
PLY-1/4-Birch	Birch 1/4" x 4' x 8'	Half Sheet 1/4" x 2' x 8'
PLY-1/2-Birch	Birch 1/2" x 4' x 8'	
PLY-3/4-Birch	Birch 3/4" x 4' x 8'	
PLY-3/8-Bending	Red Oak 3/8" x 4' x 8' (bending board)	

LUMBER

RO-06	Red Oak 3/4" x 5-1/2" S4S Lumber
RO-08	Red Oak 3/4" x 7-1/4" S4S Lumber
RO-08-B	Red Oak 3/4" x 7-1/4" Bending (29 pieces)
RO-12	Red Oak 3/4" x 11-1/4" S4S Lumber
MDF-06	MDF 11/16" x 5-1/4"
MDF-08	MDF 11/16" x 7-1/4"
MDF-12	MDF 11/16" x 11-1/4"

WOOD MOULDING & FLEXIBLE TRIM



RO-C8	Red Oak 2-1/2" x 11/16" Colonial Casing
PG-C8	Paint Grade 2-1/2" x 11/16" Colonial Casing
FLEX-C8	Paint Grade 2-1/2" x 11/16" Colonial Casing



PG-CAP MOULD	Paint Grade 1-1/8" x 3/8" Cap Mould
---------------------	-------------------------------------



RO-6007	Red Oak 1-3/4" Filet
PG-6007	Paint Grade 1-3/4" Filet



RO-6050	Red Oak 1-1/4" Filet
PG-6050	Paint Grade 1-1/4" Filet



RO-PM-1	Red Oak 11/16" x 1/-1/4" RAB, Panel Mould
PG-PM-1	Paint Grade 11/16" x 1/-1/4" RAB, Panel Mould
Flex-PM-1	Flexible Smooth 11/16" x 1/-1/4" RAB, Panel Mould
Flex-PM-1-WG	Flexible Wood Grain 11/16" x 1/-1/4" RAB, Panel Mould (1/4" Offset)



RO-PM-2	Red Oak 11/16" x 1/-1/4" RAB, Panel Mould
PG-PM-2	Paint Grade 11/16" x 1/-1/4" RAB, Panel Mould
Flex-PM-2	Flexible Smooth 11/16" x 1/-1/4" RAB, Panel Mould
Flex-PM-2-WG	Flexible Wood Grain 11/16" x 1/-1/4" RAB, Panel Mould (3/4" Offset)



RO-PM-5	Red Oak 11/16" x 1-1/8" Flat Panel Mould
PG-PM-5	Paint Grade 11/16" x 1-1/8" Flat Panel Mould
Flex-PM-5	Flexible Smooth 11/16" x 1-1/8" Flat Panel Mould
Flex-PM-5-WG	Flexible Wood Grain 11/16" x 1-1/8" Flat Panel Mould



RO-8050	Red Oak 7/16" x 3/4" Base Shoe Mould
Flex-MS-127	Flexible Smooth 7/16" x 3/4" Base Shoe Mould
Flex-MS-127-WG	Flexible Wood Grain 7/16" x 3/4" Base Shoe Mould



RO-8060	Red Oak 3/4" x 3/4" Cove Mould
PG-8060	Paint Grade 3/4" x 3/4" Cove Mould



RO-8065	Red Oak 1/2" x 1/2" Cove Mould
PG-8065	Paint Grade 1/2" x 1/2" Cove Mould
Flex-MS-101	Flexible Smooth 1/2" x 1/2" Cove Mould
Flex-MS-101-WG	Flexible Wood Grain 1/2" x 1/2" Cove Mould

ACCESSORIES

WALL RAIL BRACKET

1-1/4" x 2-3/8" Mounting Plate
3" Extension From Wall



HFBC.3002 (BRUSHED CHROME)
HFCV.3002 (COPPER VEIN)
HFORB.3002 (OIL RUBBED BRONZE)
HFRC.3002 (OIL RUBBED COPPER)
HFPB.3002 (POLISHED BRASS)
HFSC.3002 (SATIN CLEAR)
HFAG.3002 (ASH GREY)
HFSTB.3002 (SATIN BLACK)

HANDRAIL BRACKET

2-1/16" Rd. Mounting Plate
3" Extension From Wall



HFBC.3003 (BRUSHED CHROME)
HFGD.3003 (DORADO GOLD)
HFNL.3003 (NICKEL)
HFCV.3003 (COPPER VEIN)
HFORB.3003 (OIL RUBBED BRONZE)
HFRC.3003 (OIL RUBBED COPPER)
HFPB.3003 (POLISHED BRASS)
HFSC.3003 (SATIN CLEAR)
HFAG.3003 (ASH GREY)
HFSTB.3003 (SATIN BLACK)

NEWEL MOUNT HANDRAIL BRACKET

HT. 1-3/4"
Base = 1-1/2" sq.
ADJUSTABLE



HF17.4001
Stainless Steel(304)

HFSTB17.4001
Satin Black



HANDRAIL BRACKET

HT. 2-1/2"
Base = 1-1/2" x 2"
Extends 3-1/4" off wall
ADJUSTABLE



HF17.4002
Stainless Steel(304)

HFSTB17.4002
Satin Black



mounting hardware included

WOOD GLUE & FILLER



S-9202 (1 Gal.)
S-9203 (32 oz.)
S-9204 (16 oz.)
S-9205 (8 oz.)

FAM-O-WOOD S-9200
RO-9208 (Red Oak)

EPOXY GUN-EPC-101



EPOXY-EPC-410 EPC-410-BLACK



EPOXY PASTE EPC-7



OAK ROSETTES



RO-7033 4" x 5-1/2" (Red Oak)
RO-7037 4" x 5-1/2" (Red Oak)
RO-7039 4" x 4" (Red Oak)

OAK PLUGS



RO-9001 (3/8")
RO-9002 (1/2")
RO-9003 (5/8")
RO-9004 (3/4")
RO-9005 (1")
RO-9006 (1-1/4")
RO-9007 (1-1/2")

NEWEL FASTENER S-9403



Sure Tile

NEWEL FASTENER S-9401



Key Lock

NEWEL FASTENER 3019-IS



Angle Bracket
for use with 3-1/2" newels

RAIL BOLT KIT

S-9600
(Includes hex nut, spacer
and 1" Red Oak plug)



RAIL BOLT DRIVER

S-9600-D
(fits machine thread)



sold individually

DOWEL SCREW

C-905-2 (25 per bag)



DRIVER

C-905-2D
(fits wood screw thread)



sold individually

AXIA®

STAIR & RAILING SYSTEMS



STYLE



QUALITY



VALUE

We offer the most in-demand, high quality stainless steel stair & railing systems at the lowest price possible. From day one, we set out to do things a little bit different. Our goal has always been to provide stainless systems that are ideal for the residential stair installer/builder while also surpassing the expectations of the most discerning homeowners.

Sales Displays & Product Samples

Our wide variety of sales displays will provide you with the tools to sell products. We have sizes to fit your floor space. Custom displays are also available.



Axia Post Systems - Floor Display
Dimensions: 56" W x 8" D x 44" H



Axia Post Systems - Table Top Display
Dimensions: 30" W x 8" D x 24" H

Estimation Services

We offer full estimation services based on your plans. We can also offer quick-quoting based on the designs featured in our design guide.

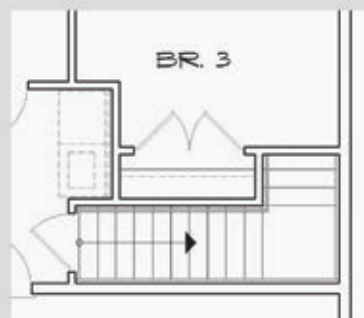

Product Catalog

Full line product catalog featuring:

- Post Railing Systems
 - Round Series
 - Square Series
- Glass Railing Systems
 - Standoff Series
 - U-Channel Series
- Installation Accessories



Design Guide

Features over thirty pre-configured stair and balcony designs for inspiration and quick quoting. This guide is a valuable sales tool and visual guide to navigate our systems.



Installation Guides

Get pro level instruction on the best way to install our systems. Loaded with tips and tricks for best results these guides cover all the basics of installation and tools/accessories.



MARKETING TOOLS

House of Forgings Modular Floor Display

Quick Installation:
Fully assembled in under 15 minutes!
Tools required: Phillips screwdriver



Display Dimensions:
30" W x 30" D x 72" H

Retail Displays Increase Sales

MODULAR DISPLAY: Our Modular Display is available as a free standing unit containing six removable panels.

DISPLAY PANELS: If floor space is an issue, we have you covered. All of our Display Panels can be ordered individually and come with wall hangers and product brochure holders pre installed.

ORDERING: To order a Modular Display or specific Display Panels, please contact your sales representative at (866) 443-4848

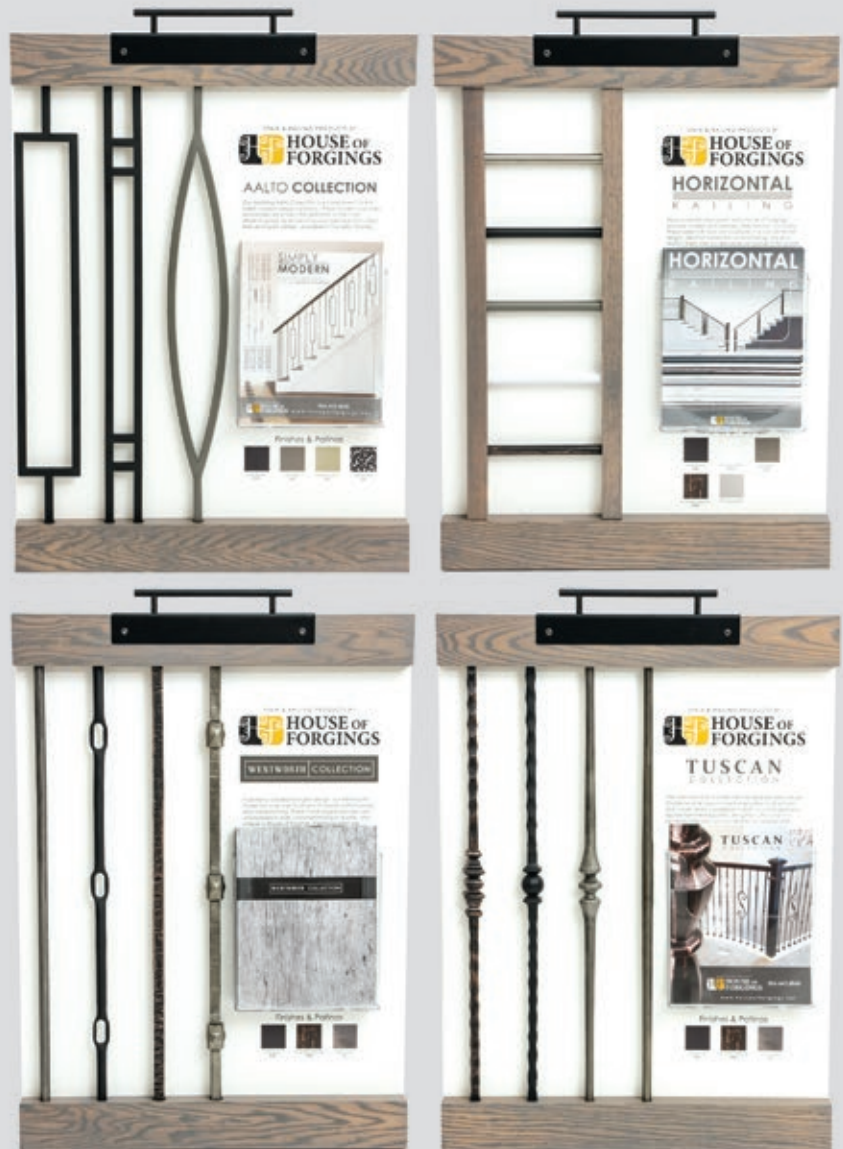

Panel Dimensions: 24" W x 2" D x 30" H

Panels available for: Harmony Collection - Soho Balustrade
Foundation Balusters - Horizontal Bar Railing
Wentworth Collection - Aalto Collection - Tuscan Collection

MARKETING TOOLS

House of Forgings Sales & Marketing Support

Sales Displays & Product Samples

Our wide variety of sales displays will provide you with the tools to sell products. We have sizes to fit your floor space. Custom displays are also available.



Powder Coated Finishes
Sample Chips



Powder Coated Finishes
Sample Balusters - 12" Length
Handrail Profile Samples
Carrying Case (4" x 14" x 25")



Carousel Floor Display
Dimensions:
18" W x 18" D x 48" H



Horizontal Bar Railing
Table Top Display
Dimensions: 24" W x 8" D x 18" H



Axia Post Systems
Table Top Display
Dimensions: 30" W x 8" D x 24" H

Software & Design

Web based Stair Artist stair design tool makes it easy to plan your staircase project. Our extensive library of CAD images and product photos will aid and inspire you in designing your staircase.



Marketing Literature

We offer a wide array of marketing literature designed to support product sales: product catalogs, brochures, flyers, postcards and customized literature are available through our authorized dealer program.

Inquire with your sales representative about product catalogs and additional product support.

CUSTOMIZATION OPTIONS

Iron Fabrication, Finishing and More

Transform Existing Products Into New Creations

We manage your fabrication project from start to finish, offering design services, estimation, project management and quality assurance. We take the hassle out of your project, leaving you more time and resources to focus on satisfying your customers with impeccable end results.

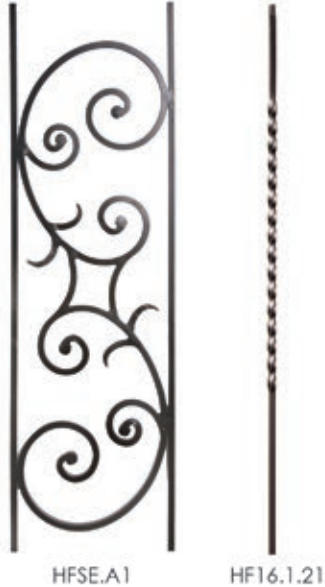

Step 1 - EXPLORE

Find existing House of Forgings parts that inspire your vision.

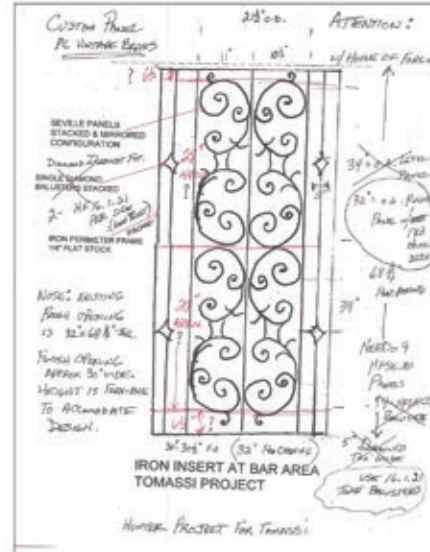

Step 2 - CONCEPT

Share your ideas and specifications for modifying an existing part.

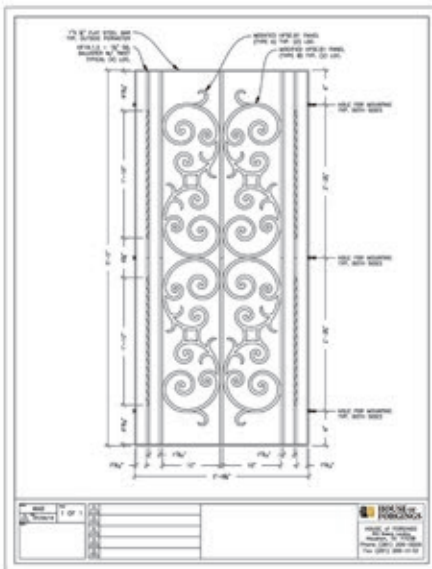

Step 3 - DESIGN

We help take your rough concepts and turn them into professional designs for your final approval.



Oil Rubbed Bronze Finish
hand applied over
Satin Black powdercoat

Step 4 - FINISHED PRODUCT

Once approved, your custom product is produced (raw or powder coated) and shipped within 2-6 weeks.

EURO FORGE

Access to Our World Class Manufacturing

ITALY · USA

DESIGN COLLABORATIVE

You Design It. We Bring It to Life!

Together with our Italian factory we bring your vision to reality. Whether you have a simple inspiration photo or detailed drawings of a single element or entire staircase we specialize in a full range of manufacturing options ideally suited to exceed your expectations.

Forging - Casting - Stamping - Bending - Rolling - Laser Cutting

Stair Parts - Decorative Panels - Window Coverings - Furniture Components - & More

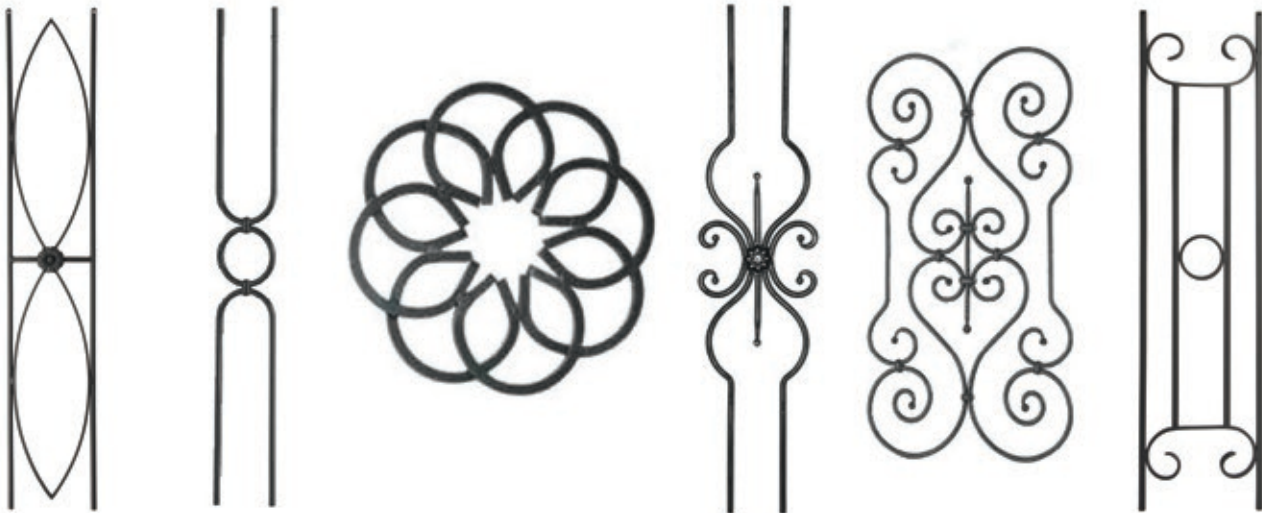

THERMA-CUT LASER CUTTING

Your drawings take shape with fully custom laser cutting for interior or exterior applications.

Sheet metal is thermally cut with high accuracy to create and transform ordinary sheet metal into decorative outdoor fencing, gates, interior panels, shelves, partitions, iron tapestries, and more.

TYPE OF MATERIAL	THICKNESS	MAXIMUM SIZE
Raw Metal (black or pickled)	20ga to 3/4"	6'6" x 13'
Pre-Galvanized	20ga to 6ga	4'11" x 13'
Corten	16ga to 3/8"	4'11" x 9'10"
Stainless 304/316	20ga to 9/16"	6'6" x 13'



Inquire for more information

