



STOCK

INTERIOR DOOR

CATALOG







INTERIOR SELECTION GUIDE	4
LIVINGSTON SERIES	5
HERITAGE SERIES	6-7
MOLDED DOORS	8-9
1-3/4" SOLID CORE MOLDED DOORS 20 MIN. FIRE RATING	10-11
CLEARY MDF DOORS	12-13
1-3/8" WOOD DOORS	14-15
FLUSH DOORS	16
POCKET DOORS SLIDER UNITS	17
BIFOLD KITS	18-19
BARN DOORS	20-21
HARDWARE	22-23
HOW TO ORDER CLEARY PREHUNGS	24
HANDING CASING PATTERNS	25
INTERIOR TRANSOMS	26
PREFINISHING	27

INTERIOR SELECTION GUIDE



LINCOLN PARK[®]
MOLDED



PR-C11
FLAT MDF



2-PANEL SMOOTH
MOLDED



LOGAN™
MOLDED



PR-C22
FLAT MDF



CHEYENNE[®]
MOLDED



2-PANEL ROMAN
MOLDED



PR-C35
FLAT MDF



WINSLOW™
MOLDED



LIVINGSTON™
MOLDED



4-PANEL
MOLDED



RIVERSIDE[®]
MOLDED



6-PANEL SMOOTH
OR TEXTURED MOLDED



6-PANEL
PINE



FLUSH BIRCH, LAUAN,
OR PRIMED HARDBOARD



1 LITE PINE
(ALSO AVAILABLE WITH
FROSTED GLASS)



1 LITE
PRIMED

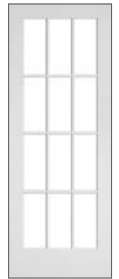

12 LITE
PRIMED

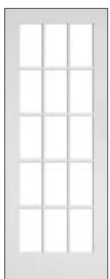

15 LITE
PRIMED



15 LITE PINE
(ALSO AVAILABLE WITH
FROSTED GLASS)

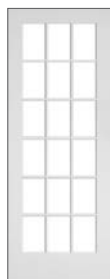

18 LITE
PRIMED



LOUVER PANEL
PRIMED



FULL LOUVER
PRIMED

ALL DOORS SHOWN IN THIS CATALOG ARE IN-STOCK AT CLEARY WHOLESALE. THEY CAN BE PURCHASED AS A DOOR SLAB OR PREHUNG.

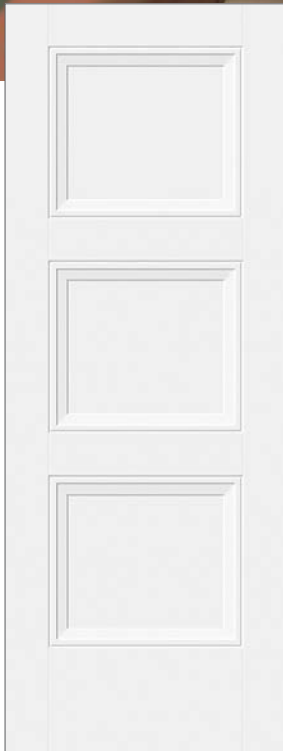

LIVINGSTON™

SMOOTH

6/8 Height | 1-3/8" Thickness

HOLLOW CORE		SOLID CORE	
1/0	2/0	1/0	2/0
1/2	2/2	1/2	2/2
1/3	2/4	1/3	2/4
1/4	2/6	1/4	2/6
1/6	2/8	1/6	2/8
1/8	2/10	1/8	2/10
1/10	3/0	1/10	3/0

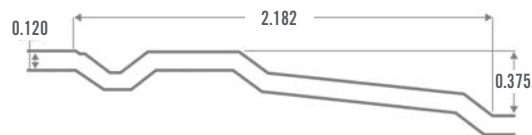





LINCOLN PARK®

1-PANEL SMOOTH FLAT PANEL

6/8 Height 1-3/8" Thickness		7/0 Height 1-3/8" Thickness	
HOLLOW CORE	SOLID CORE	HOLLOW CORE	SOLID CORE
1/0	1/0	1/6	1/6
1/2	1/2	1/10	1/10
1/3	1/3	2/0	2/0
1/4	1/4	2/2	2/2
1/6	1/6	2/6	2/4
1/8	1/8		2/6
1/10	1/10		2/8
2/0	2/0		2/10
2/2	2/2		3/0
2/4	2/4		
2/6	2/6		
2/8	2/8		
2/10	2/10		
3/0	3/0		

- Combines the classic lines of a wood Shaker door with the durability of molded panel engineering
- Feature lines distinguish architectural correctness of authentic stile and rail doors
- Smooth surface, perfect for painting and decorating
- Optional Safe N' Sound / Emerald "green" specification offered for all styles
- Full range of passage door and bifold widths available
- 20-minute fire-rating doors available in select sizes (1-3/4") (see page 11)

HERITAGE PROFILE™

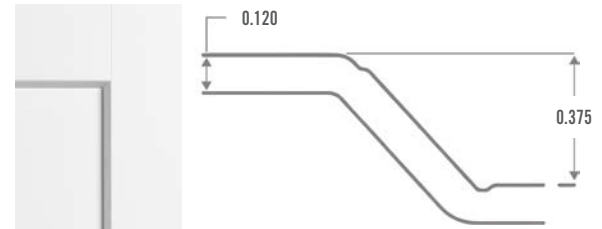

LOGAN™

2-PANEL SMOOTH FLAT PANEL

6/8 Height | 1-3/8" Thickness

HOLLOW CORE	SOLID CORE
1/0	1/0
1/2	1/2
1/3	1/3
1/4	1/4
1/6	1/6
1/8	1/8
1/10	1/10
2/0	2/0
2/2	2/2
2/4	2/4
2/6	2/6
2/8	2/8
2/10	2/10
3/0	3/0



WINSLOW™

3-PANEL SMOOTH FLAT PANEL

6/8 Height | 1-3/8" Thickness

HOLLOW CORE	SOLID CORE
1/0	1/0
1/2	1/2
1/3	1/3
1/4	1/4
1/6	1/6
1/8	1/8
1/10	1/10
2/0	2/0
2/2	2/2
2/4	2/4
2/6	2/6
2/8	2/8
2/10	2/10
3/0	3/0

NOTE: DOORS 1/8 AND UNDER HAVE 2 PANELS

MOLDED PANEL DOORS



2-PANEL

SMOOTH 6/8 Height 1-3/8" Thickness				SMOOTH 7/0 Height 1-3/8" Thickness		SMOOTH 8/0 Height 1-3/8" Thickness		
HOLLOW CORE		SOLID CORE		SOLID CORE		HOLLOW CORE	SOLID CORE	
1/0	2/0	1/0	2/0	1/6		1/8	1/6	2/4
1/2	2/2	1/2	2/2	2/0		2/0	1/8	2/6
1/3	2/4	1/3	2/4	2/4		2/2	2/0	2/8
1/4	2/6	1/4	2/6	2/6		2/4	2/2	3/0
1/6	2/8	1/6	2/8	2/8		2/6		
1/8	2/10	1/8	2/10	2/10		2/8		
1/10	3/0	1/10	3/0	3/0		3/0		



6-PANEL

SMOOTH OR TEXTURED 6/8 Height 1-3/8" Thickness				SMOOTH 7/0 Height 1-3/8" Thickness	
HOLLOW CORE		SOLID CORE		SOLID CORE	
1/0	2/0	1/0	2/0	2/0	
1/2	2/2	1/2	2/2	2/2	
1/3	2/4	1/3	2/4	2/4	
1/4	2/6	1/4	2/6	2/6	
1/6	2/8	1/6	2/8	2/8	
1/8	2/10	1/8	2/10	3/0	
1/10	3/0	1/10	3/0		

NOTE: DOORS 1/8 AND UNDER HAVE 3 PANELS

MOLDED PANEL DOORS



4-PANEL

SMOOTH

6/8 Height | 1-3/8" Thickness

HOLLOW CORE		SOLID CORE	
1/0	2/0	1/0	2/0
1/2	2/2	1/2	2/2
1/3	2/4	1/3	2/4
1/4	2/6	1/4	2/6
1/6	2/8	1/6	2/8
1/8	2/10	1/8	2/10
1/10	3/0	1/10	3/0

NOTE: DOORS 1/8 AND UNDER HAVE 2 PANELS



CHEYENNE®

2-PANEL CAMBER TOP PLANK SMOOTH

6/8 Height | 1-3/8" Thickness

HOLLOW CORE		SOLID CORE	
1/0	2/0	1/0	2/0
1/2	2/2	1/2	2/2
1/3	2/4	1/3	2/4
1/4	2/6	1/4	2/6
1/6	2/8	1/6	2/8
1/8	2/10	1/8	2/10
1/10	3/0	1/10	3/0



RIVERSIDE®

5-PANEL EQUAL SMOOTH

6/8 Height | 1-3/8" Thickness

SOLID CORE	
1/0	2/0
1/2	2/2
1/3	2/4
1/4	2/6
1/6	2/8
1/8	2/10
1/10	3/0



2-PANEL ROMAN

SMOOTH

6/8 Height | 1-3/8" Thickness

HOLLOW CORE		SOLID CORE	
1/0	2/0	1/0	2/0
1/2	2/2	1/2	2/2
1/3	2/4	1/3	2/4
1/4	2/6	1/4	2/6
1/6	2/8	1/6	2/8
1/8	2/10	1/8	2/10
1/10	3/0	1/10	3/0

SMOOTH

8/0 Height | 1-3/8" Thickness

HOLLOW CORE		SOLID CORE	
2/0	1/6	2/4	
2/6	1/8	2/6	
	2/0	2/8	
	2/2	3/0	

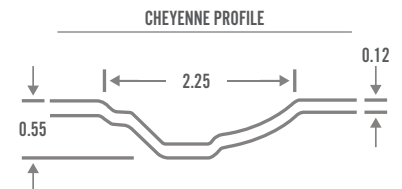
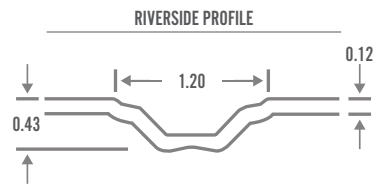
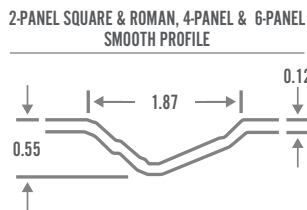
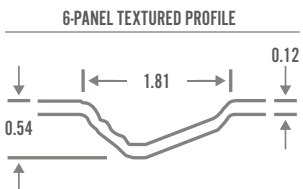

1-3/4" MOLDED





6-PANEL
SMOOTH

6/8 Height	
2/8	3/0

7/0 Height	
2/8	3/0



2-PANEL
SMOOTH

6/8 Height		
2/6	2/8	3/0

7/0 Height	
2/8	3/0

8/0 Height	
2/8	3/0



4-PANEL
SMOOTH

6/8 Height	
2/8	3/0



2-PANEL ROMAN
SMOOTH

6/8 Height	
2/8	3/0

8/0 Height	
2/8	3/0



CHEYENNE®
2-PANEL CAMBER TOP PLANK SMOOTH

6/8 Height	
2/8	3/0



LINCOLN PARK®
1-PANEL SMOOTH FLAT PANEL

6/8 Height	
2/8	3/0



LOGAN™
2-PANEL SMOOTH FLAT PANEL

6/8 Height	
2/8	3/0



WINSLOW™
3-PANEL SMOOTH FLAT PANEL

6/8 Height	
2/8	3/0



LIVINGSTON™
3-PANEL SMOOTH

6/8 Height	
2/8	3/0

Fire-rated doors are often used in the house to the garage, as well as commercial applications including multi-family.

*Prehung in wood label frame or prehung in fast frame adjustable steel frame

Note: 20 minute fire rated wood frames are only available single rabbetted

CLEARY MDF DOORS



PR-C22

6/8 Height				7/0 Height				8/0 Height		1-3/4" DOORS		
OVOLO STICKING		SQUARE STICKING		OVOLO STICKING		SQUARE STICKING		OVOLO STICKING	SQUARE STICKING	SQUARE STICKING	SQUARE STICKING	SQUARE STICKING
1/0	2/0	1/0	2/0	1/6	1/6	2/4	1/6	1/6		1/6		2/0
1/2	2/2	1/2	2/2	2/0	1/8	2/6	1/8	2/0		2/0		2/6
1/3	2/4	1/3	2/4	2/6	2/0	2/8	2/0	2/4		2/2		2/8
1/4	2/6	1/4	2/6	2/8	2/4	2/10	2/4	2/6		2/4		3/0
1/6	2/8	1/6	2/8	2/10	2/6	3/0	2/6	2/8		2/6		
1/8	2/10	1/8	2/10	3/0	2/8		2/8	3/0*		2/8*		
1/10	3/0	1/10	3/0		2/10		3/0	3/0*		3/0*		
					3/0							



PR-C11

1-3/8" DOORS		1-3/4" DOORS		
6/8 Height		6/8 Height	7/0 Height	8/0 Height
SQUARE STICKING		SQUARE STICKING	SQUARE STICKING	SQUARE STICKING
1/0	2/0	1/6	1/6	2/0
1/2	2/2	2/0	2/0	2/6
1/3	2/4	2/2	2/2	2/8
1/4	2/6	2/4	2/4	3/0
1/6	2/8	2/6	2/6	
1/8	2/10	2/8*	2/8*	
1/10	3/0	3/0*	3/0*	



PR-C30

1-3/8" DOORS	
6/8 Height	
SQUARE STICKING	
1/0	2/0
1/2	2/2
1/3	2/4
1/4	2/6
1/6	2/8
1/8	2/10
1/10	3/0

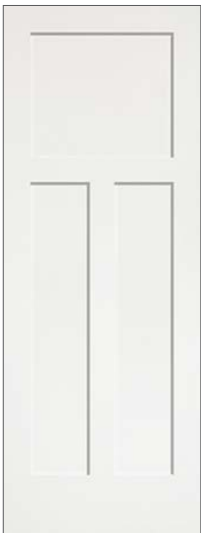

PR-C35

1-3/8" DOORS		1-3/4" DOORS		
6/8 Height		6/8 Height	7/0 Height	8/0 Height
SQUARE STICKING		SQUARE STICKING	SQUARE STICKING	SQUARE STICKING
1/0	2/0	1/6	1/6	2/0
1/2	2/2	2/0	2/0	2/6
1/3	2/4	2/2	2/2	2/8
1/4	2/6	2/4	2/4	3/0
1/6	2/8	2/6	2/6	
1/8	2/10	2/8*	2/8*	
1/10	3/0	3/0*	3/0*	



PR-C55

1-3/8" DOORS	
6/8 Height	
SQUARE STICKING	
1/0	2/0
1/2	2/2
1/3	2/4
1/4	2/6
1/6	2/8
1/8	2/10
1/10	3/0

* AVAILABLE AS DOOR SLAB ONLY, PREHUNG, OR PREHUNG WITH 20-MINUTE FIRE RATING.

IN ADDITION TO STOCKED MDF DOORS, CLEARY WHOLESALE OFFERS A FULL LINE OF MDF MADE TO ORDER DOORS.

CLEARY MDF DOORS



CONSTRUCTION

TRUE MORTISE & TENON JOINERY | SOLID WOOD CORE WITH MDF VENEER | 1/2" MDF FLAT PANELS

Both the stiles and rails have a solid wood core to provide greater strength and stability. The MDF veneers on the stiles and rails allow for a smooth and consistent paint finish. Panels are solid 1/2" MDF. Utilizing traditional mortise and tenon joinery, all pieces are hand fit together with the industry's finest adhesives on all connections.

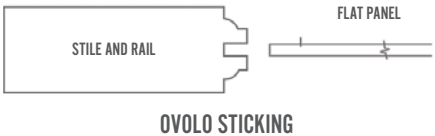
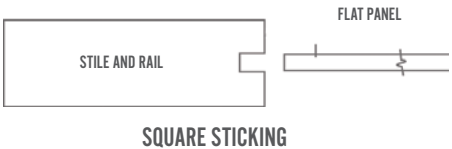
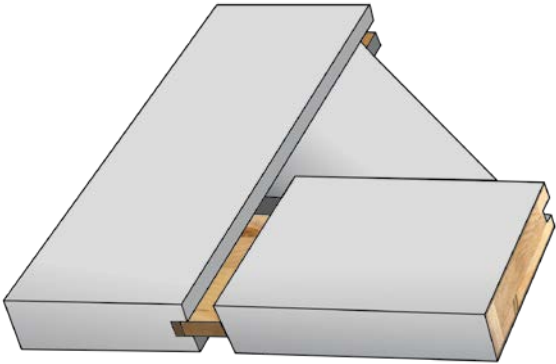

Scan for additional
MDF door options



WOOD DOORS



PINE
6-PANEL CLEAR PINE

6/8 Height 1-3/8" Thickness	
1/0	2/0
1/2	2/2
1/3	2/4
1/4	2/6
1/6	2/8
1/8	2/10
1/10	3/0



PINE
1-LITE CLEAR PINE

6/8 Height 1-3/8" Thickness	
1/6	2/6
2/0	2/8
2/4	3/0



PINE
1-LITE FROSTED CLEAR PINE

6/8 Height 1-3/8" Thickness	
2/0	2/8
2/4	3/0
2/6	

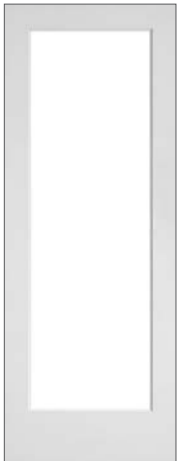

PRIMED
1-LITE

6/8 Height 1-3/8" Thickness	
2/0	2/8
2/4	3/0
2/6	



PRIMED
FULL LOUVER (730)

6/8 Height 1-3/8" Thickness	
1/0	2/0
1/2	2/4
1/3	2/6
1/4	2/8
1/6	2/10
1/8	3/0
1/10	



PRIMED
LOUVER / PANEL (732)

6/8 Height	1-3/8" Thickness
1/0	1/10
1/2	2/0
1/3	2/4
1/4	2/6
1/6	2/8
1/8	3/0



PINE
15-LITE CLEAR PINE

6/8 Height 1-3/8" Thickness	
2/0	
2/4	
2/6	
2/8	
3/0	

2/0 = 10 lite



PINE
15-LITE
SATIN FROSTED
CLEAR PINE

6/8 Height 1-3/8" Thickness	
2/0	
2/4	
2/6	
2/8	
3/0	

2/0 = 10 lite



PRIMED
15-LITE

6/8 Height 1-3/8" Thickness	
1/6	
2/0	
2/4	
2/6	
2/8	
2/10	
3/0	

1/6 = 5 lite
2/0 = 10 lite

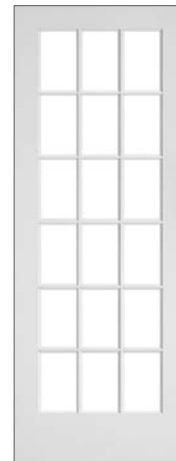

PRIMED
18-LITE

8/0 Height 1-3/8" Thickness	
2/0	
2/6	
2/8	
3/0	

2/0 = 12 lite

WOOD DOORS



FLUSH DOORS



SEE THE CLEARY / WHOLESALE DOORS COMMERCIAL CATALOG FOR OUR EXTENSIVE OFFERING OF FLUSH DOORS

PRIMED HARDBOARD

6/8 Height | 1-3/8" thickness

HOLLOW CORE	
1/0	2/0
1/2	2/2
1/3	2/4
1/4	2/6
1/6	2/8
1/8	2/10
1/10	3/0

6/8 Height | 1-3/8" thickness

SOLID CORE	
1/6	2/8
2/0	2/10
2/4	3/0
2/6	

6/8 Height | 1-3/4" thickness

SOLID CORE	
2/0	2/8
2/6	3/0

7/0 Height | 1-3/4" thickness

SOLID CORE	
2/0	2/8
2/6	3/0

BIRCH

6/8 Height | 1-3/8" thickness

HOLLOW CORE	
1/0	2/0
1/2	2/2
1/3	2/4
1/4	2/6
1/6	2/8
1/8	2/10
1/10	3/0

6/8 Height | 1-3/8" thickness

SOLID CORE	
1/0	2/0
1/2	2/2
1/3	2/4
1/4	2/6
1/6	2/8
1/8	3/0
1/10	

7/0 Height | 1-3/8" thickness

SOLID CORE	
3/0	

LAUAN

6/8 Height | 1-3/8" thickness

HOLLOW CORE	
1/0	2/0
1/2	2/2
1/3	2/4
1/4	2/6
1/6	2/8
1/8	2/10
1/10	3/0

6/8 Height | 1-3/8" thickness

SOLID CORE	
1/0	1/10
1/2	2/0
1/3	2/4
1/4	2/6
1/6	2/8
1/8	3/0

7/0 Height | 1-3/8" thickness

SOLID CORE	
3/0	

6/8 Height | 1-3/4" thickness

SOLID CORE		
2/6*	2/8*	3/0*

7/0 Height | 1-3/4" thickness

SOLID CORE		
3/0*		

*20 MIN FIRE RATED

POCKET DOORS

JOHNSON HARDWARE

COMMERICAL GRADE POCKET DOOR FRAMES K.D.

- Designed for fast installation in standard 2 x 4 timber or steel frame stud walls sheeted with drywall.
- Set contains removable aluminum track, guaranteed jump proof smooth rolling triangle hangers, rust resistant zinc plated steel reinforced timber split studs and self adjusting floor anchors.
- Frames can be adapted for use in thicker walls or cut down to accept any smaller size door.

- Door thickness 1" - 1-3/4" up to 125lbs standard duty, 200lbs heavy duty
- Sizes in stock: Up to 3/0 x 6/8 standard duty
Up to 3/0 x 7/0, 3/0 x 8/0, 4/0 x 8/0 heavy duty
- Optional soft close & open kit available.



SLIDING DOORS

STANDARD SLIDING UNIT

- 4-9/16 clear or primed flat jamb, K.D.
- Facia: 1/2" x 1-1/8" applied to header.
- Rollers applied to the doors, sliding track integral to head jamb with wood facia. Doors drilled for cup pulls (bright brass is standard). Floor guide in bag.





2-PANEL
MOLDED SMOOTH
6/8 Height | 1-3/8" Thickness

HOLLOW CORE	
2/0	3/0
2/4	4/0
2/6	5/0
2/8	6/0



2-PANEL ROMAN
MOLDED SMOOTH
6/8 Height | 1-3/8" Thickness

HOLLOW CORE	
2/0	4/0
2/6	5/0
3/0	6/0



WINSLOW™
MOLDED SMOOTH FLAT PANEL
6/8 Height | 1-3/8" Thickness

HOLLOW CORE	
2/0	4/0
2/6	5/0
3/0	6/0



6-PANEL
MOLDED SMOOTH
6/8 Height | 1-3/8" Thickness

HOLLOW CORE	
2/0	3/0
2/4	4/0
2/6	5/0
2/8	6/0



6-PANEL
MOLDED TEXTURED
6/8 Height | 1-3/8" Thickness

HOLLOW CORE	
2/0	3/0
2/4	4/0
2/6	5/0
2/8	6/0



LIVINGSTON™
MOLDED SMOOTH
6/8 Height | 1-3/8" Thickness

HOLLOW CORE	
2/0	4/0
2/6	5/0
3/0	6/0



CHEYENNE®
MOLDED SMOOTH
6/8 Height | 1-3/8" Thickness

HOLLOW CORE	
2/0	4/0
2/6	5/0
3/0	6/0



LINCOLN PARK®
MOLDED SMOOTH FLAT PANEL
6/8 Height | 1-3/8" Thickness

HOLLOW CORE	
2/0	4/0
2/6	5/0
3/0	6/0



LOGAN™
MOLDED SMOOTH FLAT PANEL
6/8 Height | 1-3/8" Thickness

HOLLOW CORE	
2/0	4/0
2/6	5/0
3/0	6/0



PRIMED
LOUVER / PANEL
6/8 Height | 1-3/8" Thickness

2/0	4/0
2/6	5/0
2/8	6/0
3/0	



PRIMED
FULL LOUVER
6/8 Height | 1-3/8" Thickness

2/0	4/0
2/6	5/0
2/8	6/0
3/0	



HARDBOARD
FLUSH PRIMED
6/8 Height | 1-3/8" Thickness

HOLLOW CORE	
2/0	4/0
2/6	5/0
3/0	6/0

BIFOLD KITS



BIRCH / LAUAN

FLUSH

6/8 Height | 1-3/8" Thickness

HOLLOW CORE

2/0	3/0
2/4	4/0
2/6	5/0
2/8	6/0



PINE

6-PANEL PINE

6/8 Height | 1-3/8" Thickness

2/0	3/0
2/4	4/0
2/6	5/0
2/8	6/0

BARN DOORS



K STYLE KNOTTY PINE
36" x 84" x 1-3/8"
(Ideal for openings 28" - 34")

IN STOCK



CAPTIVA K STYLE PRIMED MDF
36" x 84" x 1-3/8"
(Ideal for openings 28" - 34")

IN STOCK

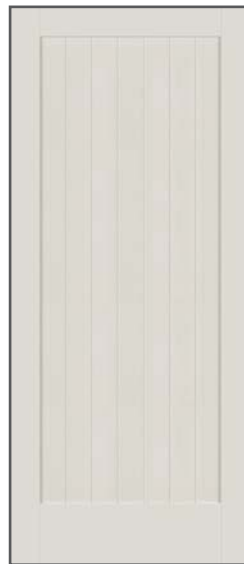

CAPTIVA 1 PANEL
PRIMED MDF
36" x 84" x 1-3/8"
(Ideal for openings 28" - 34")

MADE TO ORDER



CAPTIVA 2 PANEL
PRIMED MDF PRIMED MDF
36" x 84" x 1-3/8"
(Ideal for openings 28" - 34")

MADE TO ORDER

TURN ANY INTERIOR DOOR INTO A BARN DOOR

PICK YOUR DOOR SLAB & YOUR HARDWARE



STRAIGHT STRAP KIT

Stocked in Stainless Steel or Matte Black (shown)



BENT STRAP KIT

Stocked in Stainless Steel or Matte Black (shown)



TOP OF DOOR STRAP KIT

Stocked in Stainless Steel (shown) or Matte Black



Scan for additional
barn door options



TOP OF DOOR STRAP KIT



BENT STRAP KIT



HARDWARE

HINGES

5/8 RADIUS



3-1/2" x 3-1/2"

Light Brass*
Dull Brass
Primed
Bright Chrome*
Dull Chrome*
Oil Rubbed Bronze*

Satin Nickel*
Bright Brass†
Antique Brass
Black
Antique Nickel



4" x 4"

Light Brass
Bright Chrome†
Dull Chrome**
Black
Oil Rubbed Bronze†

Satin Nickel†
Bright Brass†
Antique Brass
Antique Nickel
Stainless Steel*

* Stocked 5/8 Radius Ball Bearing

† Stocked 5/8 Radius Spring

• Stocked on 5/8 Radius Non Removable Pin

SQUARE CORNER



3-1/2" x 3-1/2"

Bright Brass
Solid Bright Brass
Black

Primed
Bright Chrome

4" x 4"

Bright Brass
Solid Bright Brass
Black

Primed Template USP
Oil Rubbed Bronze

SQUARE CORNER BALL BEARING



3-1/2" x 3-1/2"

Bright Brass
Dull Chrome

Oil Rubbed Bronze
Satin Nickel

Black

4" x 4"

Bright Brass
Satin Nickel

Oil Rubbed Bronze
Black

Dull Chrome



SOSS CONCEALED HINGES



1-3/4" (218)

Bright Brass
Dull Chrome
Satin Nickel

1-3/8" (212)

Bright Brass
Dull Chrome
Oil Rubbed Bronze
Satin Nickel

HARDWARE

CATCHES

BALL CATCHES



BALL CATCH

Light Brass



STRIKE PLATE

Light Brass Oil Rubbed Bronze
Dull Chrome Bright Chrome
Satin Nickel Black

CONCEALED MAGNETIC CATCH



1" x 2"

Satin Chrome

- No latch noise when opening and shutting door (unlike a roller/ball catch)
- Completely concealed when door closed, no unsightly protruding strike plate lip.
- Self adhesive/magnetic cover plate protects magnets from impact damage during installation and from corrosion.
- Can be used anywhere a roller/ball catch would normally be fitted.

MAGNETIC CATCH



**STANDARD DUTY
MAGNETIC CATCH**



**HEAVY DUTY DUAL TRIPLE POLE
MAGNETIC CATCH**



6" FLUSH BOLTS AVAILABLE IN BRIGHT BRASS & SATIN NICKEL

LOCKSETS

AVAILABLE IN PASSAGE, PRIVACY, BATH, DUMMY, KEY, ENTRANCE AND DEADBOLT



ACCENT

Satin Nickel 619 Aged Bronze 716 Black 622



PLYMOUTH

Brass 605 Aged Bronze 716 Brass 605 / Chrome 625
Satin Nickel 619 Chrome 625 Black 622



LATITUDE

Satin Nickel 619 Black 622

POCKET DOOR LATCHES



PASSAGE

1-3/4" x 2-1/4"

Bright Brass Dull Chrome
Dull Chrome Aged Bronze
Black



PRIVACY

1-3/4" x 2-1/4"

Bright Brass Dull Chrome
Dull Chrome Aged Bronze
Black



HOW TO ORDER

SPECIFY	EXAMPLE	SPECIFY	EXAMPLE
Single or double prehung	Single	Wall thickness or jamb width	4-5/8"
Door size and thickness	2/6 x 6/8 - 1-3/8"	Casing (clear or primed / type)	1 x 4 primed flat
Door style	C-35	Hinge size/type	3-1/2", 5/8 radius
Door swing (see 'Handing')	RH	Hinge finish	Bright brass
Jamb (clear or primed / type)	Primed double rabbet	Hardware type and preps	Standard

CLEARLY PREHUNG

STANDARD INTERIOR UNITS:

- Edge Prep: 1" x 2-1/4", 1/4" radius latch, 1/4" radius full lip strike plate, no prep with double doors.
- Bore: 2-1/8" hole, 2-3/8" backset, double doors no bore.
- Clearance: 1-1/4" from the bottom of the door to the bottom of the jamb.
- Rough Opening: Door width + 2-1/2", door height + 2-1/2".

DOUBLE RABBETED JAMB

- Jamb: Primed and FJ double rabbet (DR) 4-11/16"
- Hinges for 1-3/8" doors: 1-1/2 pair, 3-1/2" x 3-1/2" light brass, 5/8" radius
- Hinges for 1-3/4" doors: 1-1/2 pair, 4" x 4" (light brass), 5/8" radius.

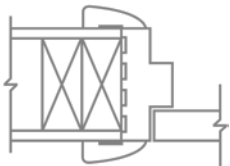

SINGLE RABBETED JAMB

- Jamb: Clear or primed single rabbet (SR) 4-5/8"
- Hinges for 1-3/8" doors: 1-1/2 pair, 3-1/2" x 3-1/2" light brass, 5/8" radius
- Hinges for 1-3/4" doors: 1-1/2 pair, 4" x 4" (light brass), 5/8" radius.

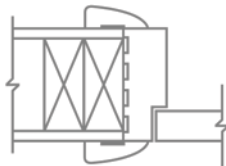

FLAT JAMB

- Jamb: Clear or Primed and FJ flat jamb 4-5/8" with WM888 E1E stops.
- Hinges for 1-3/8" doors: 1-1/2 pair, 3-1/2" x 3-1/2" light brass, 5/8" radius
- Hinges for 1-3/4" doors: 1-1/2 pair, 4" x 4" (light brass), 5/8" radius.

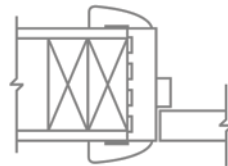

SPLIT JAMB

- Jamb: Clear or primed and FJ split jamb 4-1/2" - 5-1/8" wall thickness.
- Hinges: 1-1/2 pair, 3-1/2" x 3-1/2" light brass, 5/8" radius, 3 pair with double doors.



Custom jambs available in many species and sizes



HANDING

SINGLE DOORS		DOUBLE DOORS	
--------------	--	--------------	--

RH



LH



RH ACTIVE



LH ACTIVE



Pull the door towards you when standing on the side the hinge is exposed.

If the knob is on the left of the door = LH

If the knob is on the right of the door = RH

CASING PATTERNS

2-1/2"

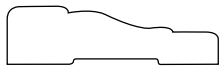

Colonial



Clam

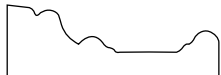

Baby Windsor

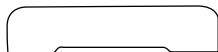

Chairrail

3-1/2"

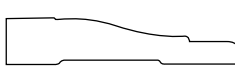

Colonial

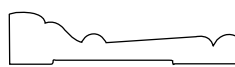

Stafford

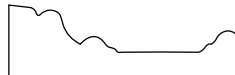

Windsor



Alexandria

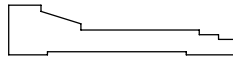

AB / HM9105-3

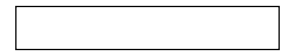

1 x 4 or 1 x 5

4-15/32"

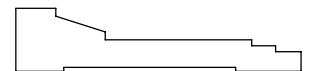

AB / HM9105

Or your choice of WindsorONE Mouldings or our Captiva Custom moulding patterns

INTERIOR TRANSOMS



WOOD TRANSOMS

	STANDARD LITE LAYOUT	BASIC UNIT SIZE 13-1/2" TRANSOMS	APPROXIMATE EXPOSED GLASS SIZE PER LITE
2'4 Single door or cased opening	3	29-1/2" x 13-1/2"	8" x 11-1/4"
2'6 Single door or cased opening	3	31-1/2" x 13-1/2"	8-1/2" x 11-1/4"
2'8 Single door or cased opening	3	33-1/2" x 13-1/2"	9-1/4" x 11-1/4"
3'0 Single door or cased opening	4	37-1/2" x 13-1/2"	7-3/4" x 11-1/4"
4'0 Double door *	5	49-1/2" x 13-1/2"	8-1/4" x 11-1/4"
5'0 Double door *	7	61-1/2" x 13-1/2"	7-1/4" x 11-1/4"
5'4 Double door *	7	65-1/2" x 13-1/2"	7-5/8" x 11-1/4"
6'0 Double door *	8	73-1/2" x 13-1/2"	7-3/4" x 11-1/4"

* For double doors with astragals add 3/8" in width to sizes shown

Transoms add 13-1/2" to door height RO. Actual glass size order equals basic unit size in width - 1-3/4", height - 1-5/8"

Example: 3'0 single door transom with a basic unit size 37-1/2" x 13-1/2" uses glass 35-3/4" x 11-7/8"

- Single pane 3/16" annealed glass.
- Simulated divided lite with 1-3/16" muntin bars.
- 4-5/8" clear or primed flat jamb with stop. Will match door unit.
- Standard transom is 13-1/2" height, other sizes are available special order.
- Includes trim to match door unit.

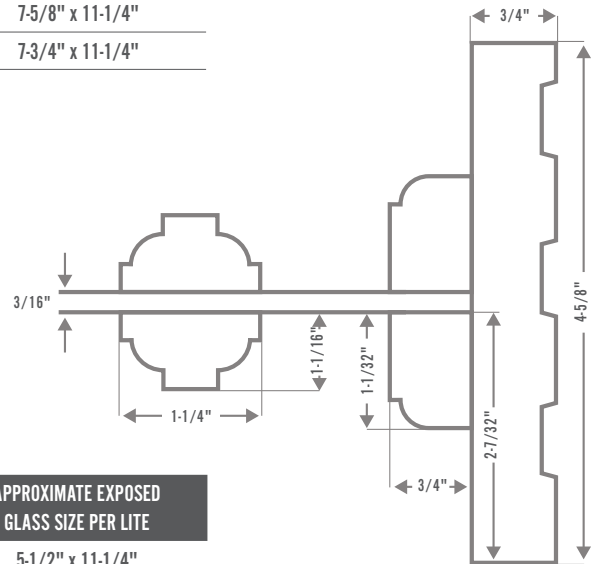

SIMULATED DIVIDED LITE TRANSOMS WITH WIDE STILES

	STANDARD LITE LAYOUT	BASIC UNIT SIZE 13-1/2" TRANSOMS	APPROXIMATE EXPOSED GLASS SIZE PER LITE
2'4 Single door or cased opening	3	29-1/2" x 13-1/2"	5-1/2" x 11-1/4"
2'6 Single door or cased opening	3	31-1/2" x 13-1/2"	6-1/8" x 11-1/4"
2'8 Single door or cased opening	3	33-1/2" x 13-1/2"	6-3/4" x 11-1/4"
3'0 Single door or cased opening	3	37-1/2" x 13-1/2"	8-1/8" x 11-1/4"
4'0 Double door *	5	49-1/2" x 13-1/2"	6-3/4" x 11-1/4"
5'0 Double door *	7	61-1/2" x 13-1/2"	6-1/4" x 11-1/4"
5'4 Double door *	7	65-1/2" x 13-1/2"	6-3/4" x 11-1/4"
6'0 Double door *	7	73-1/2" x 13-1/2"	7-7/8" x 11-1/4"

* For double doors with astragals add 3/8" in width to sizes shown

Transoms add 13-1/2" to door height RO. For 12" transoms add 12" to door height RO.

- Transom includes wide wood stiles.
- Single pane 3/16" annealed glass.
- Simulated divided lite with 1-3/16" muntin bars.
- 4-5/8" clear or primed flat jamb with stop.
- Standard transom is 13-1/2" height, other heights are available.

STOCK PAINT COLORS

Nothing beats the convenience and superior quality of a professionally applied factory finish. Fortress Coating Systems™ uses the latest technology to save time and provide consistent quality. Fortress finishes come with a 10 year warranty.

SW 2838 POLISHED MAHOGANY

SW 2848 ROYCROFT PEWTER

SW 6243 DISTANCE

SW 6244 NAVAL

SW 6258 TRICORN BLACK

SW 6454 SHAMROCK

SW 6502 LOCH BLUE

SW 6711 PARAKEET

SW 6799 SOAR

SW 6868 REAL RED

SW 6883 RAUCOUS ORANGE

SW 6902 DECISIVE YELLOW

SW 7005 PURE WHITE

SW 7048 URBANE BRONZE

SW 7510 CHATEAU BROWN

SW 7526 MAISON BLANCHE

SW 7593 RUSTIC RED

SW 7669 SUMMIT GRAY

FC 511 TRUE BLACK

Fortress COATING SYSTEMS™

Custom colors are also available. Please supply Sherwin Williams or Benjamin Moore paint number and name.

Custom paint matching available with physical sample and extended lead time.

Due to variations of printing of this catalog, or viewing on a screen, actual colors may vary. Please ask your sales rep for color samples.



Cleary

WHOLESALE

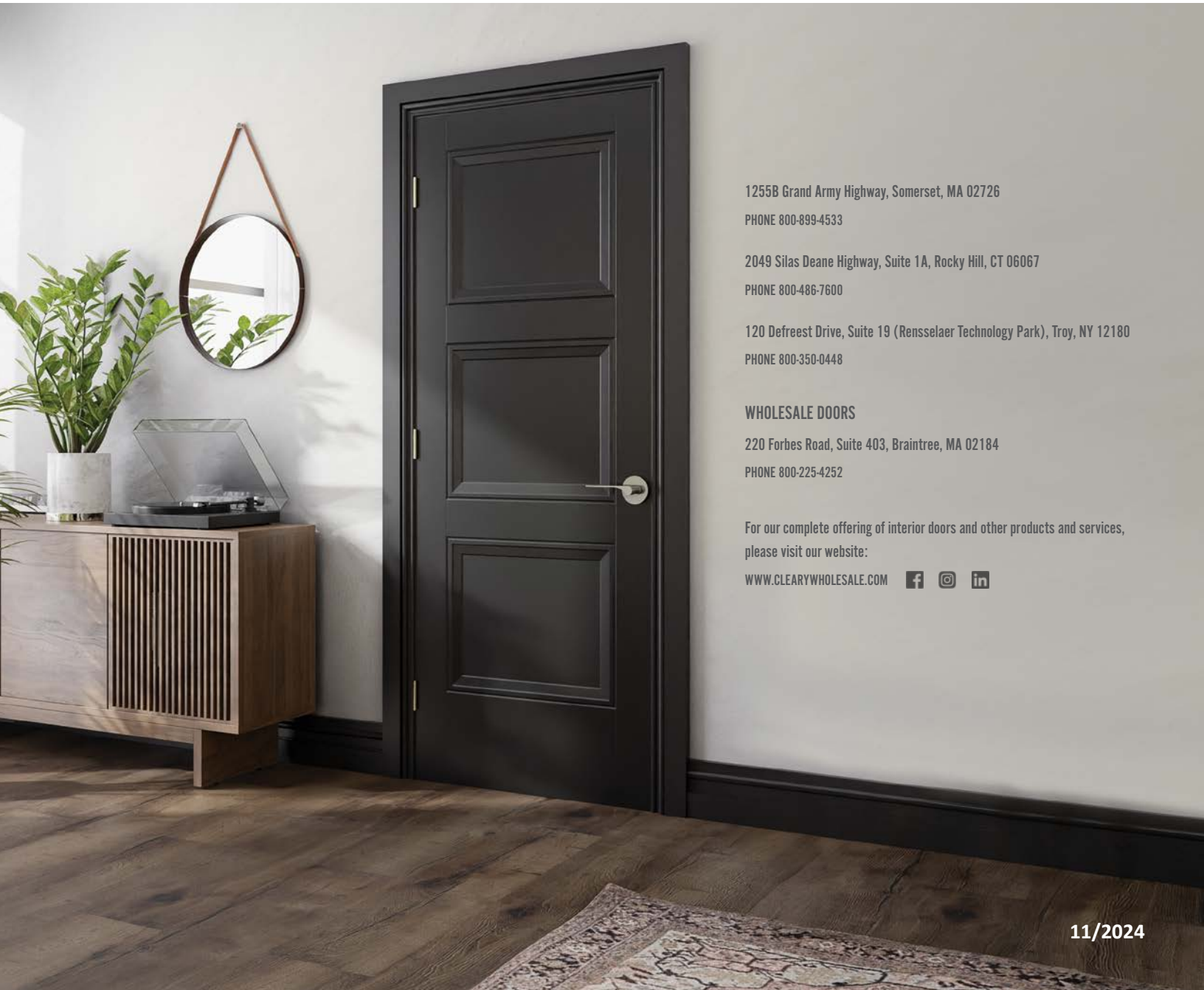

1255B Grand Army Highway, Somerset, MA 02726

PHONE 800-899-4533

2049 Silas Deane Highway, Suite 1A, Rocky Hill, CT 06067

PHONE 800-486-7600

120 Defreest Drive, Suite 19 (Rensselaer Technology Park), Troy, NY 12180

PHONE 800-350-0448

WHOLESALE DOORS

220 Forbes Road, Suite 403, Braintree, MA 02184

PHONE 800-225-4252

For our complete offering of interior doors and other products and services,
please visit our website:

WWW.CLEARYWHOLESALE.COM

