



architectural mouldings

{ STOCK, SELECT CUSTOM, WINDSORONE, A&B, AND METRIE }





The sky's the limit!

From our standard offering of stock mouldings to our custom mouldings, Cleary can provide a moulding for your unique specifications. Need an exact replica of a historical moulding? ...we can do it! Would you like to custom design your own signature profile? ...you can count on us!



The details of fine millwork can make a home unique. Cleary Wholesale offers everything from stock to custom millwork. Our large stocking inventory of mouldings, jambs, columns, and custom millwork make it easy for lumberyards to fill the needs of their customers from a basic trim package to intricate custom millwork.

We are pleased to present this collection of some of our most popular moulding profiles.

MOULDING COMPONENTS GUIDE	3
ABOUT STOCK MOULDINGS	5
ABOUT WINDSORONE MOULDINGS	6
ABOUT METRIE MOULDINGS	9
ABOUT CUSTOM MOULDINGS	10
PREFINISHING	13
MORE ONLINE	15
BASE	16-27
CASING	28-57
CURVED CASING	58
CHAIRRAIL	59
CROWN	60-71
BUILT UP CROWNS	72-78
ROSETTES	79
STOOLS & NOSING	80-82
BOARDS & FLAT TRIM	83-85
MISC MOULDINGS A-Z	86-91
INDEX	INSIDE BACK COVER

Visit us at ClearyWholesale.com to browse our complete moulding collection and download DWG and PDF files.

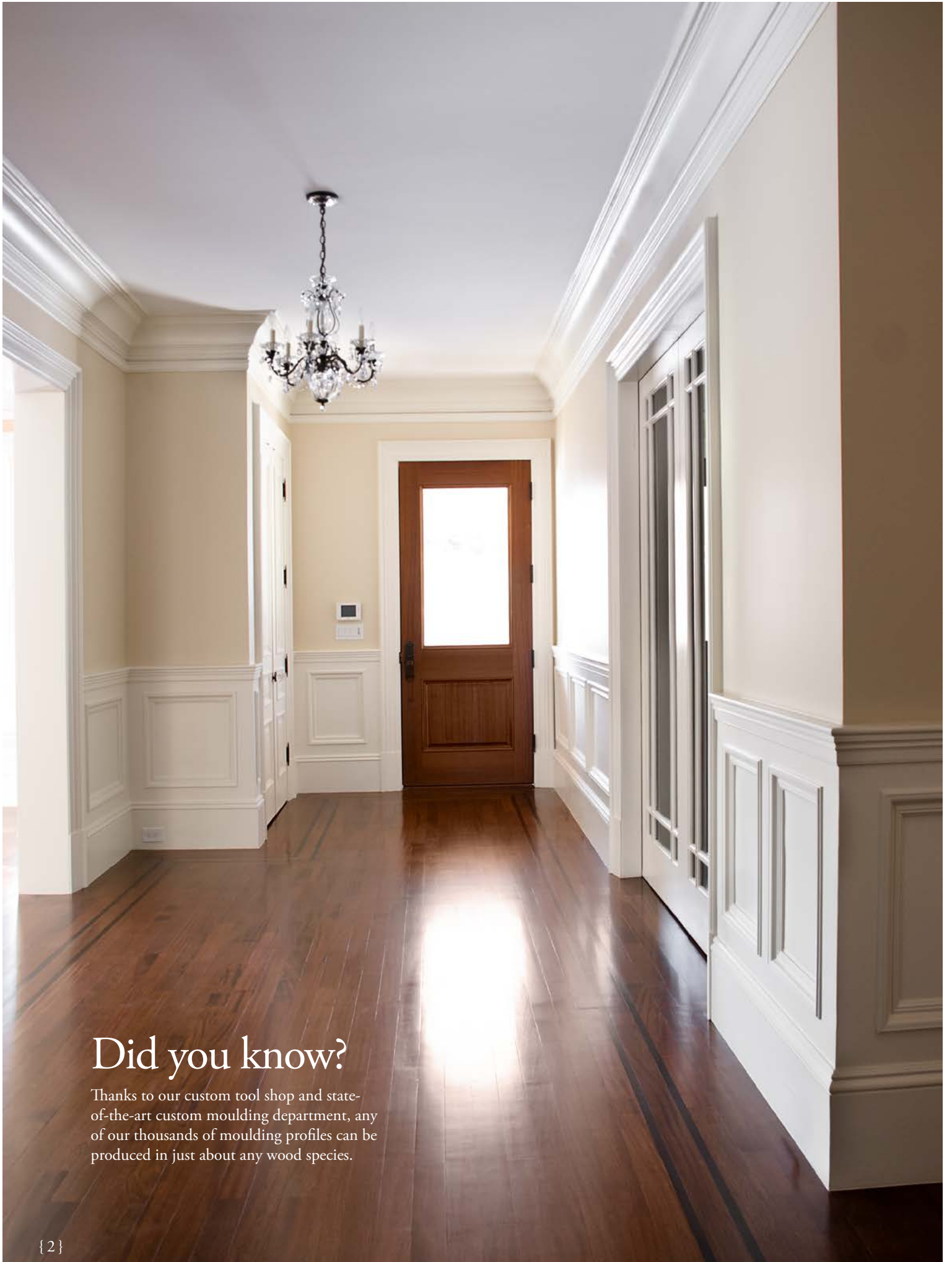

Did you know?

Thanks to our custom tool shop and state-of-the-art custom moulding department, any of our thousands of moulding profiles can be produced in just about any wood species.

Know your moulding components...

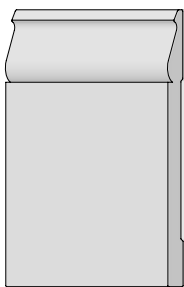

BASE
Applied around the perimeter of a room where the walls meet the finished floor. Can consist of up to three components: the flat baseboard, a base cap, and a base shoe.



STOOL CAP
Serves as the interior extension of the window sill. Immediately below the stool cap a piece of horizontal trim called the apron is applied against the wall (as pictured above).

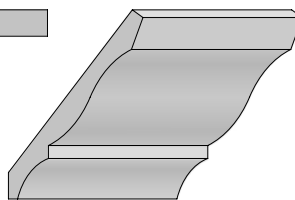

CROWN
Applied around the perimeter of a room where the walls meet the ceiling. Can be one piece or a built-up unit consisting of multiple components (for built-up crowns see page 72).

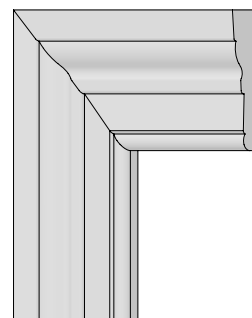

CASING
Used for trimming out door and window openings. More intricate casings can include a backband moulding or head casing.



CHAIRRAIL
Typically applied to the perimeter of a room 36" above the floor. Chairrail was originally intended to prevent chairs from marring the wall. As pictured above, chairrail is sometimes used as the top component to wainscotting.



Stock mouldings



We carry a full line of standard stock mouldings available for immediate delivery. Our stock lineal mouldings include an array of casings, bases, crowns, sills, chairrails, and much more. We also carry a wide variety of rosettes available in-stock in primed poplar and clear pine, or by special order in any custom species you desire.

P M C CP FP SP W M F V

Look for these symbols throughout this catalog to know if a moulding is stocked in our warehouse and what species and finish we stock it in. Any moulding profile bearing one of these symbols is also available special order in any wood species with a short lead time.

P FINGER JOINTED & PRIMED
M MEDIUM DENSITY FIBERBOARD

C CLEAR PINE
CP CLEAR POPLAR

FP FJ POPLAR DOUBLE PRIMED
SP SOLID POPLAR (NO FJ) DOUBLE PRIMED

W WINDSORONE TRIPLE COAT PRIME
M METRIE 3 DAY LEAD TIME

F FLEXIBLE
V CURVED

WindsorONE mouldings



WINDSORONE
CRAFTSMANSHIP PAYS

From the precision quality of their historically accurate moldings to their unique whole-room concept, WindsorONE mouldings perfect any home, whether it was built in 1820 or is just being designed today. Each of their four styles include all the mouldings and trim needed to complete an entire room. A three-coat process applied to all six sides of the board with a premium white, 100% acrylic latex primer is vacuum-applied for a perfect finish.

 We have included a selection of WindsorONE's most popular profiles in this catalog. In addition to what is shown here, Cleary Wholesale also stocks WindsorONE's full line of moulding profiles from all four whole-room collections, S4S flat trim boards, shiplap and nickel gap.

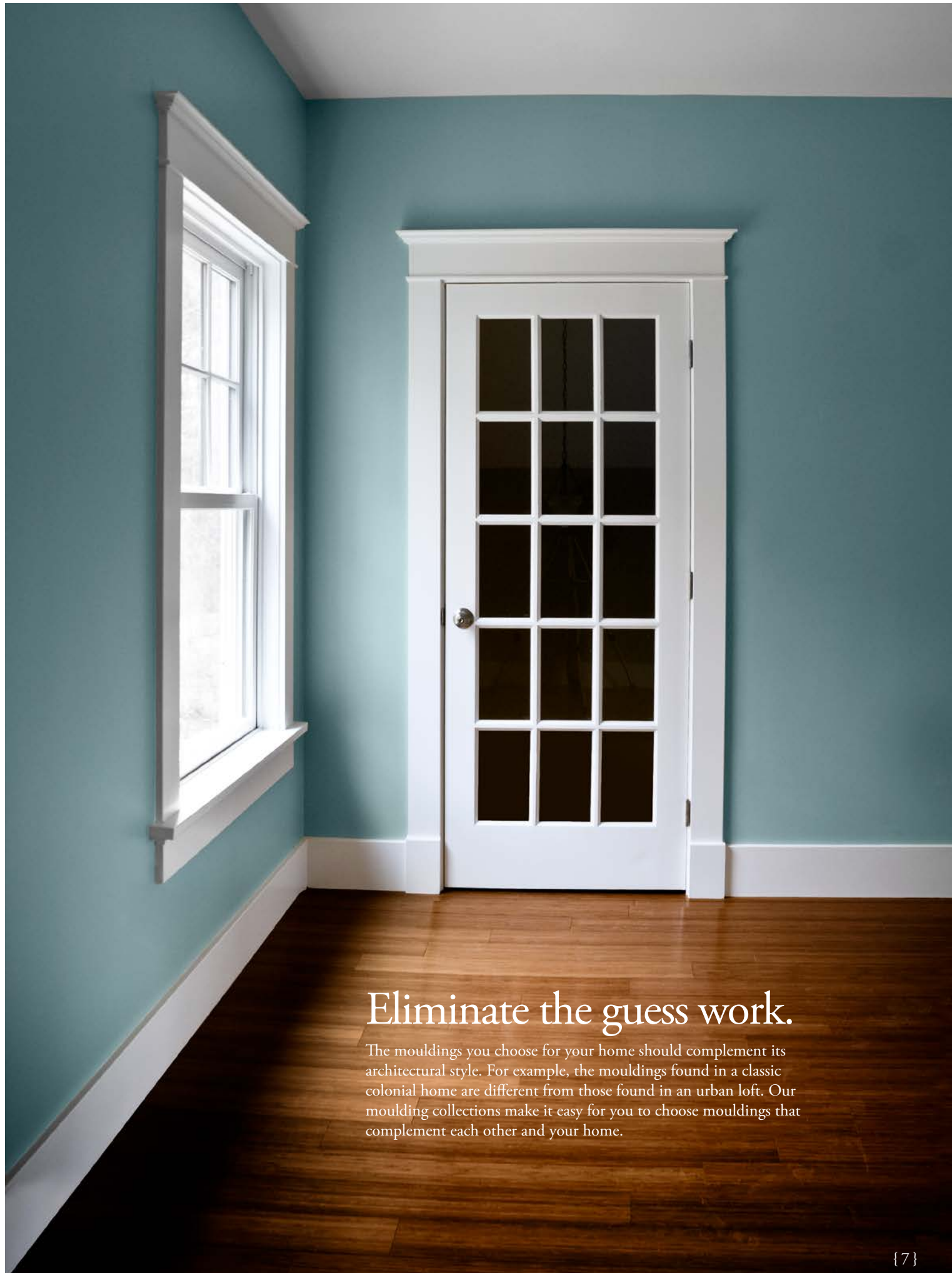

Eliminate the guess work.

The mouldings you choose for your home should complement its architectural style. For example, the mouldings found in a classic colonial home are different from those found in an urban loft. Our moulding collections make it easy for you to choose mouldings that complement each other and your home.



Metrie mouldings



METRIE®

THE ART OF FORM

Since their beginnings as a small family-owned business in 1926, Metrie's dedication to creating high-quality, finely crafted architectural elements has helped them grow to become one of the largest manufacturers of solid wood and composite moulding in North America. We love Metrie's large inventory, modern profiles, and architecturally correct proportions.

 Look for the Metrie logo throughout this catalog to find some of our favorite Metrie mouldings. Visit metrie.com for their complete offering of mouldings. Most Metrie mouldings are available for delivery in 3 business days or less.

Captiva custom mouldings



CAPTIVA

When your project requires or deserves custom wood mouldings, Cleary Wholesale has the capability and expertise. With our state-of-the-art knife grinder and moulder, we are able to produce the highest quality mouldings available. Simply provide us with a sample or sketch and we'll produce your own unique moulding pattern in any species of wood. With our quick set up machinery and our in-house knife grinding, you will find our lead times and prices meet most schedules and budgets.

Ⓝ Look for this symbol throughout this catalog to indicate which profiles shown are from our Captiva custom mouldings collection. We have included a small selection of some of our most popular profiles, but our full library can be easily viewed online at captivacustom.com/moulding-cad-drawings.

Any moulding profile throughout this catalog can be produced in any hardwood or softwood species with a short lead time.



Visit our CAD Library to view and download drawings of all of our custom mouldings.





Fortress Coating Systems™ prefinishing



Fortress COATING SYSTEMS™

Save time and job site labor costs by having your custom mouldings from Cleary Wholesale prefinished with Fortress Coating Systems. Each piece of custom moulding comes directly from our state-of-the-art Weinig moulder to the finish line. Choose a superior primed or clear coat finish, stain, or any Sherwin Williams paint color. Our process gives you a more durable finish than you could achieve by hand.



More online

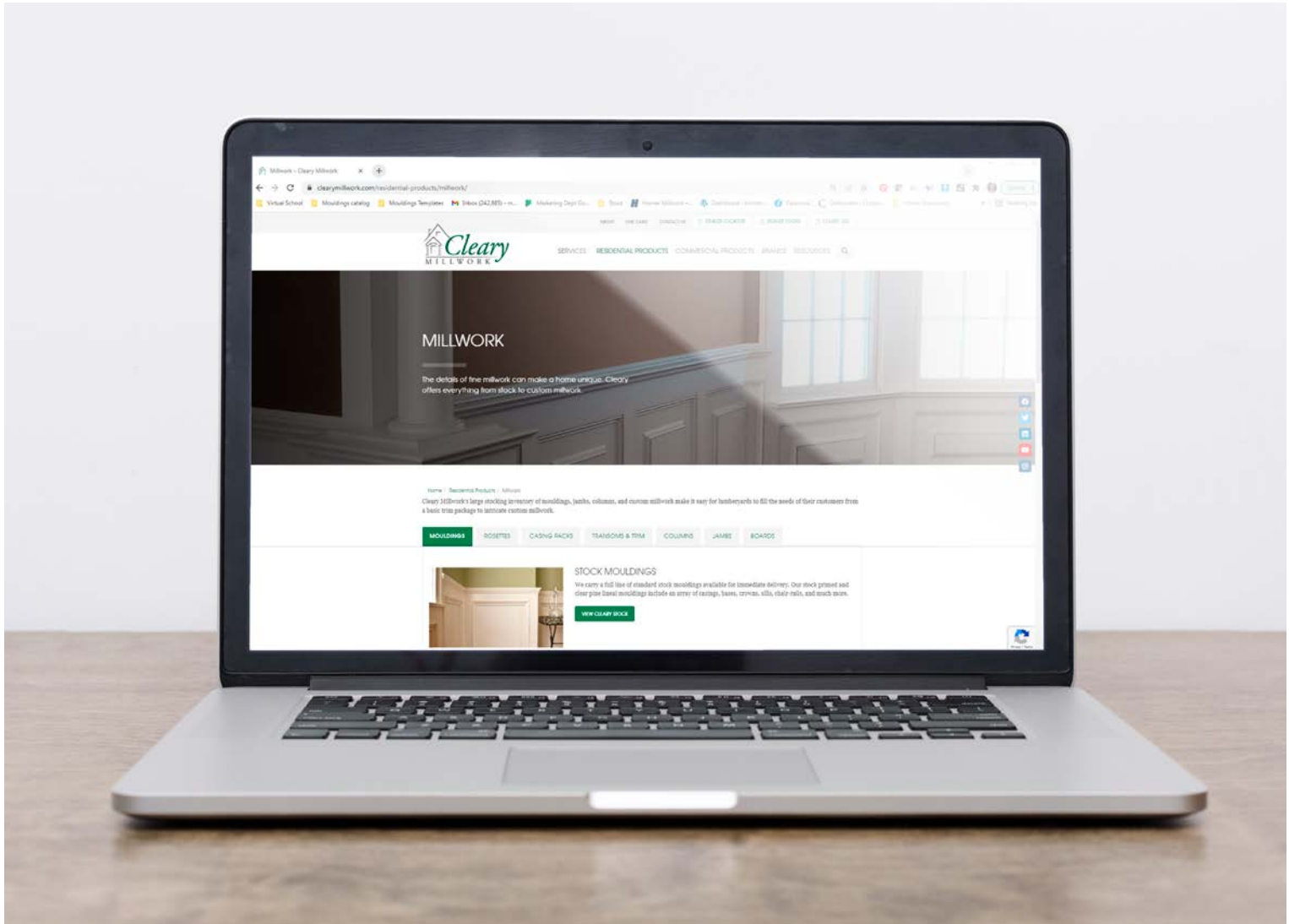

Visit us online at ClearyWholesale.com to browse our complete moulding collection and download DWG and PDF files.



BASE

Base

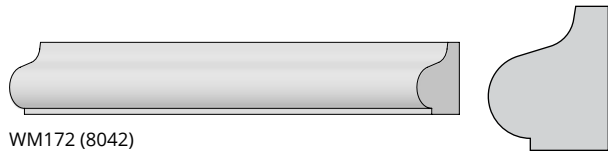

WM172 (8042)
5/8" x 3/4"

P



WOBS001
Classic Craftsmen
1/2" x 3/4"

W

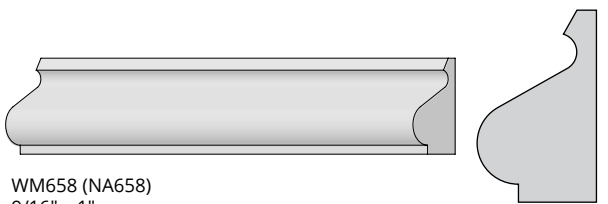

WM658 (NA658)
9/16" x 1"

P

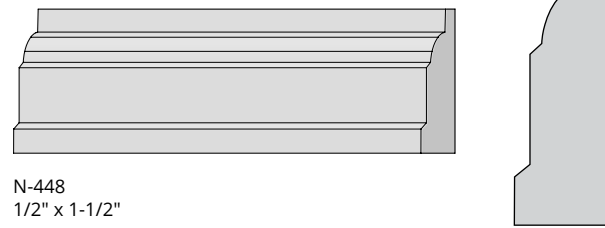

N-448
1/2" x 1-1/2"

NS

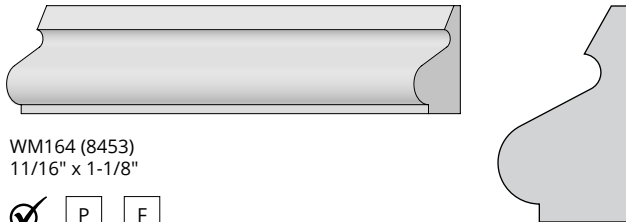

WM164 (8453)
11/16" x 1-1/8"

P F

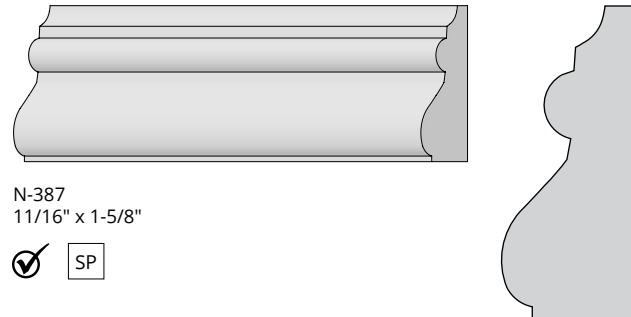

N-387
11/16" x 1-5/8"

SP

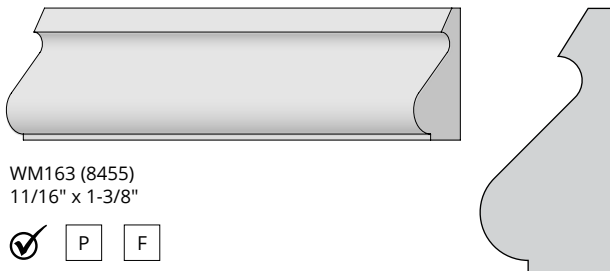

WM163 (8455)
11/16" x 1-3/8"

P F

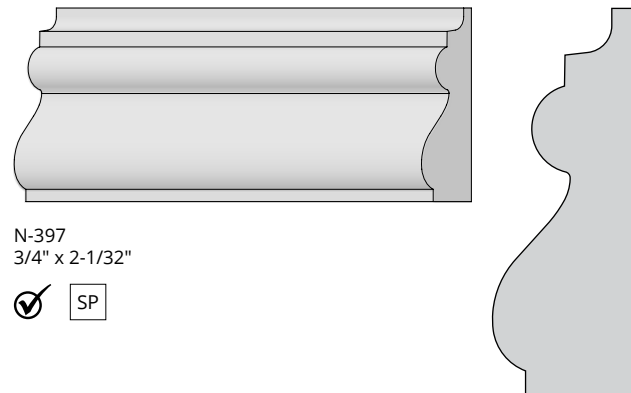

N-397
3/4" x 2-1/32"

SP

P FINGER JOINTED & PRIMED
 M MEDIUM DENSITY FIBERBOARD

C CLEAR PINE
 CP CLEAR POPLAR

FP FJ POPLAR DOUBLE PRIMED
 SP SOLID POPLAR (NO FJ) DOUBLE PRIMED

W WINDSORONE TRIPLE COAT PRIME
 M METRIE 3 DAY LEAD TIME

F FLEXIBLE
 V CURVED, PG. 58

STOCK
 NS NON-STOCK AVAILABLE FOR QUICK DELIVERY



WM662 (8385A)
 Colonial
 9/16" x 3-1/2"

P C



WM662 (8385A)

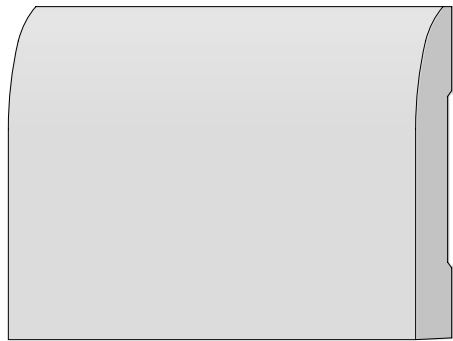

WM712 (8720)
 Clam
 9/16" x 3-1/2"

C



WM712 (8720)

<input type="checkbox"/> P FINGER JOINTED & PRIMED	<input type="checkbox"/> C CLEAR PINE	<input type="checkbox"/> FP FJ POPLAR DOUBLE PRIMED	<input type="checkbox"/> W WINDSORONE TRIPLE COAT PRIME	<input type="checkbox"/> F FLEXIBLE	<input checked="" type="checkbox"/> STOCK
<input type="checkbox"/> M MEDIUM DENSITY FIBERBOARD	<input type="checkbox"/> CP CLEAR POPLAR	<input type="checkbox"/> SP SOLID POPLAR (NO FJ) DOUBLE PRIMED	<input type="checkbox"/> M METRIE 3 DAY LEAD TIME	<input type="checkbox"/> V CURVED, PG. 58	<input type="checkbox"/> NS NON-STOCK AVAILABLE FOR QUICK DELIVERY

BASE



WM430 (NA609)
9/16" x 4-1/4"



WM430 (NA609)

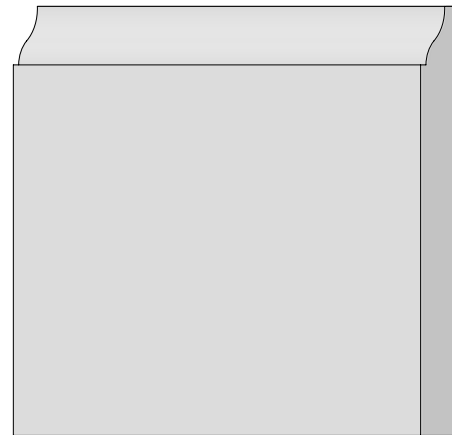

N-135
9/16" x 4-15/32"



N-135

P FINGER JOINTED & PRIMED	C CLEAR PINE	FP FJ POPLAR DOUBLE PRIMED	W WINDSORONE TRIPLE COAT PRIME	F FLEXIBLE	<input checked="" type="checkbox"/> STOCK
M MEDIUM DENSITY FIBERBOARD	CP CLEAR POPLAR	SP SOLID POPLAR (NO FJ) DOUBLE PRIMED	M METRIE 3 DAY LEAD TIME	V CURVED, PG. 58	NS NON-STOCK AVAILABLE FOR QUICK DELIVERY

9" SAMPLES AVAILABLE UPON REQUEST. ALL MOULDINGS AVAILABLE IN ANY HARDWOOD OR SOFTWOOD SPECIES WITH SHORT LEAD TIME. AVAILABLE UNFINISHED, DOUBLE PRIMED, CLEAR FINISHED, STAINED OR PAINTED. WE HAVE KNIVES FOR OVER 5,000 PATTERNS AND WE ADD NEW CUSTOM PATTERNS EVERY DAY!

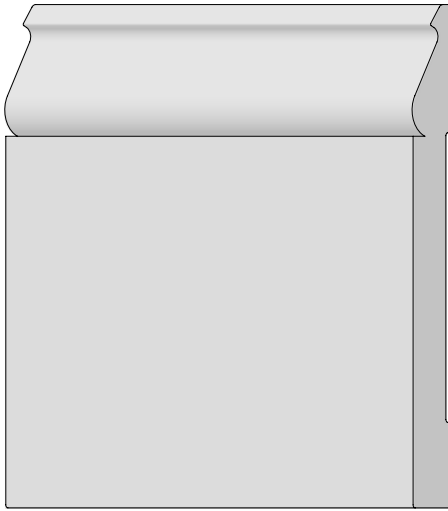

WMSBASE
 Speed Base
 9/16" x 5-1/4"

P C M

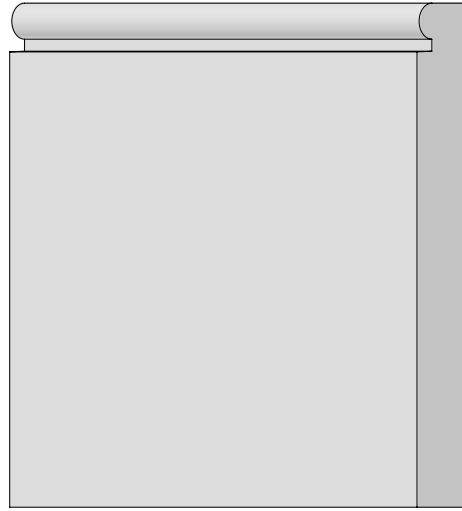

N-92
 3/4" x 5-1/4"

NS



WMSBASE



N-92

<input type="checkbox"/> P FINGER JOINTED & PRIMED	<input type="checkbox"/> C CLEAR PINE	<input type="checkbox"/> FP FJ POPLAR DOUBLE PRIMED	<input type="checkbox"/> W WINDSORONE TRIPLE COAT PRIME	<input type="checkbox"/> F FLEXIBLE	<input checked="" type="checkbox"/> STOCK
<input type="checkbox"/> M MEDIUM DENSITY FIBERBOARD	<input type="checkbox"/> CP CLEAR POPLAR	<input type="checkbox"/> SP SOLID POPLAR (NO FJ) DOUBLE PRIMED	<input type="checkbox"/> M METRIE 3 DAY LEAD TIME	<input type="checkbox"/> V CURVED, PG. 58	<input type="checkbox"/> NS NON-STOCK AVAILABLE FOR QUICK DELIVERY

BASE

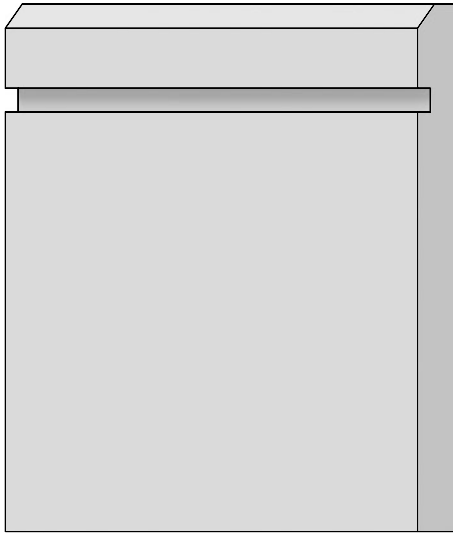

1683733
Metrie Urban Loft
9/16" x 5-1/2"

PRIMED
FJ POPLAR

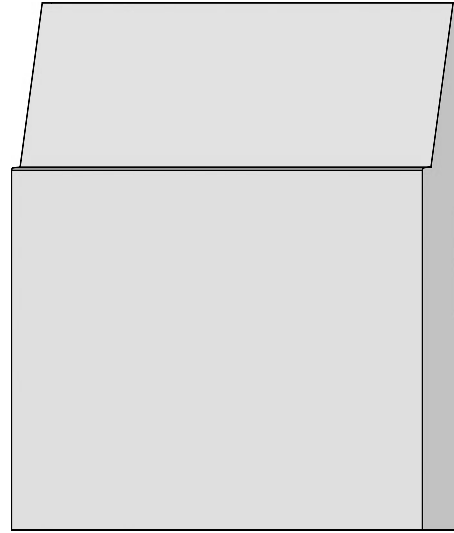

1680231
Metrie Modern Farmhouse
9/16" x 5-1/2"

PRIMED
FJ PINE

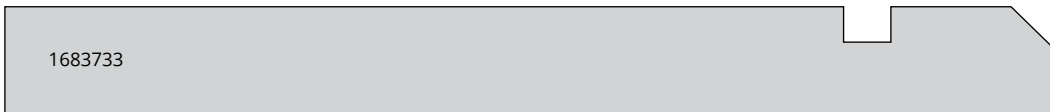

1683733



1680231

FINGER JOINTED & PRIMED
 MEDIUM DENSITY FIBERBOARD

CLEAR PINE
 CLEAR POPLAR

FJ POPLAR DOUBLE PRIMED
 SOLID POPLAR (NO FJ) DOUBLE PRIMED

WINDSORONE TRIPLE COAT PRIME
 METRIE 3 DAY LEAD TIME

FLEXIBLE
 CURVED, PG. 58

STOCK
 NON-STOCK AVAILABLE FOR QUICK DELIVERY

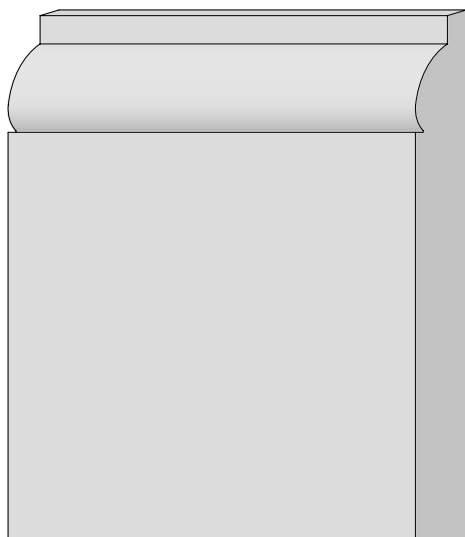

WOBM002
 Greek Revival
 3/4" x 5-1/2"

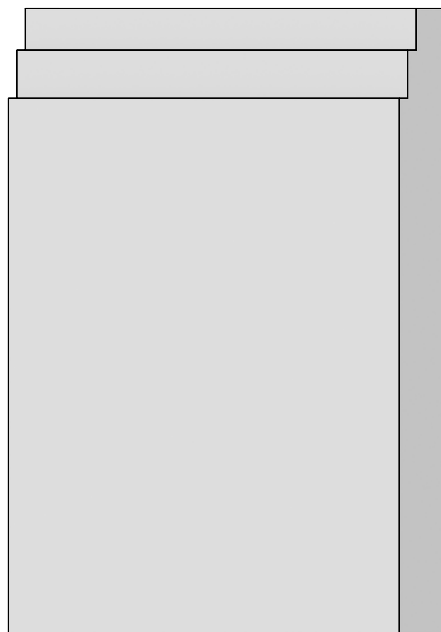

AB/HM9205
 A&B Wood Design
 21/32" x 6-1/2"



WOBM002



AB/HM9205

<input type="checkbox"/> P FINGER JOINTED & PRIMED	<input type="checkbox"/> C CLEAR PINE	<input type="checkbox"/> FP FJ POPLAR DOUBLE PRIMED	<input type="checkbox"/> W WINDSORONE TRIPLE COAT PRIME	<input type="checkbox"/> F FLEXIBLE	<input checked="" type="checkbox"/> STOCK
<input type="checkbox"/> M MEDIUM DENSITY FIBERBOARD	<input type="checkbox"/> CP CLEAR POPLAR	<input type="checkbox"/> SP SOLID POPLAR (NO FJ) DOUBLE PRIMED	<input type="checkbox"/> M METRIE 3 DAY LEAD TIME	<input type="checkbox"/> V CURVED, PG. 58	<input type="checkbox"/> NS NON-STOCK AVAILABLE FOR QUICK DELIVERY

BASE

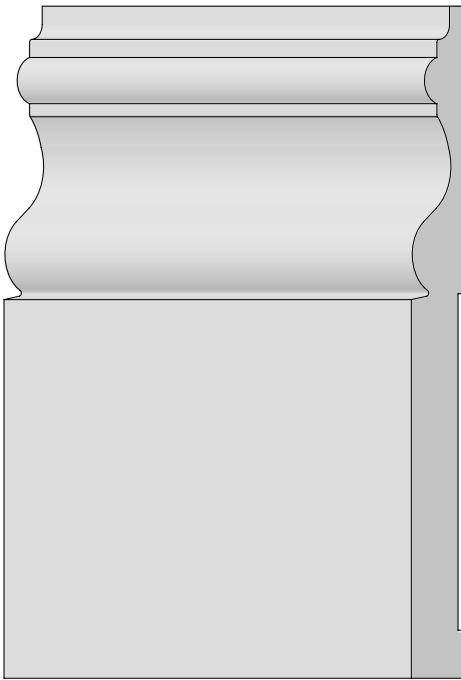

N-857
3/4" x 7"

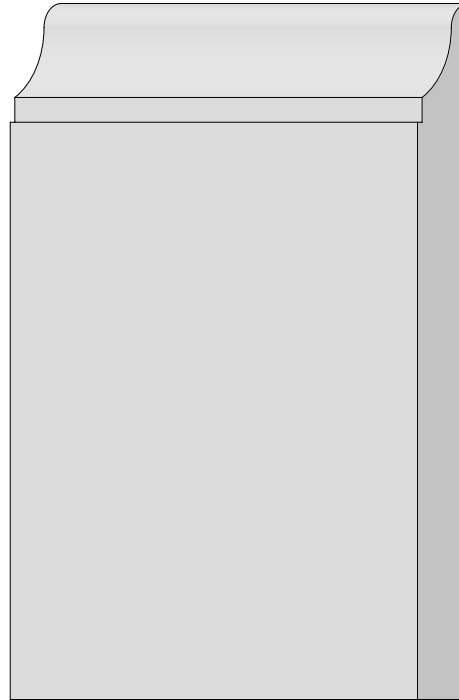

WOBM004
Colonial Revival
3/4" x 7-1/4"



N-857



WOBM004

P FINGER JOINTED & PRIMED	C CLEAR PINE	FP FJ POPLAR DOUBLE PRIMED	W WINDSORONE TRIPLE COAT PRIME	F FLEXIBLE	<input checked="" type="checkbox"/> STOCK
M MEDIUM DENSITY FIBERBOARD	CP CLEAR POPLAR	SP SOLID POPLAR (NO FJ) DOUBLE PRIMED	M METRIE 3 DAY LEAD TIME	V CURVED, PG. 58	NS NON-STOCK AVAILABLE FOR QUICK DELIVERY

9" SAMPLES AVAILABLE UPON REQUEST. ALL MOULDINGS AVAILABLE IN ANY HARDWOOD OR SOFTWOOD SPECIES WITH SHORT LEAD TIME. AVAILABLE UNFINISHED, DOUBLE PRIMED, CLEAR FINISHED, STAINED OR PAINTED. WE HAVE KNIVES FOR OVER 5,000 PATTERNS AND WE ADD NEW CUSTOM PATTERNS EVERY DAY!

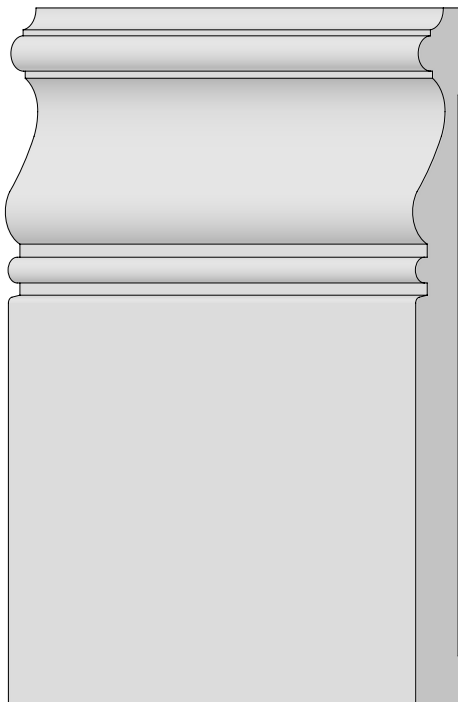

N-125
 5/8" x 7-1/4"

(NS)

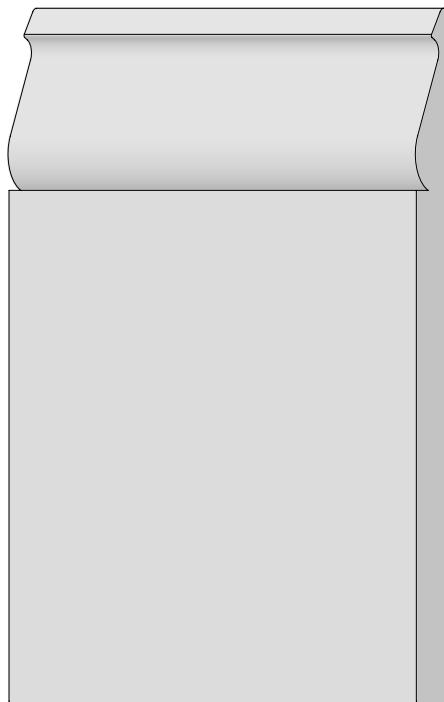

WMSBASEMDF
 Speed Base
 9/16" x 7-1/4"

✓ P M



N-125



WMSBASEMDF

<input type="checkbox"/> P FINGER JOINTED & PRIMED	<input type="checkbox"/> C CLEAR PINE	<input type="checkbox"/> FP FJ POPLAR DOUBLE PRIMED	<input type="checkbox"/> W WINDSORONE TRIPLE COAT PRIME	<input type="checkbox"/> F FLEXIBLE	<input checked="" type="checkbox"/> STOCK
<input type="checkbox"/> M MEDIUM DENSITY FIBERBOARD	<input type="checkbox"/> CP CLEAR POPLAR	<input type="checkbox"/> SP SOLID POPLAR (NO FJ) DOUBLE PRIMED	<input type="checkbox"/> M METRIE 3 DAY LEAD TIME	<input type="checkbox"/> V CURVED, PG. 58	<input type="checkbox"/> (NS) NON-STOCK AVAILABLE FOR QUICK DELIVERY

BASE

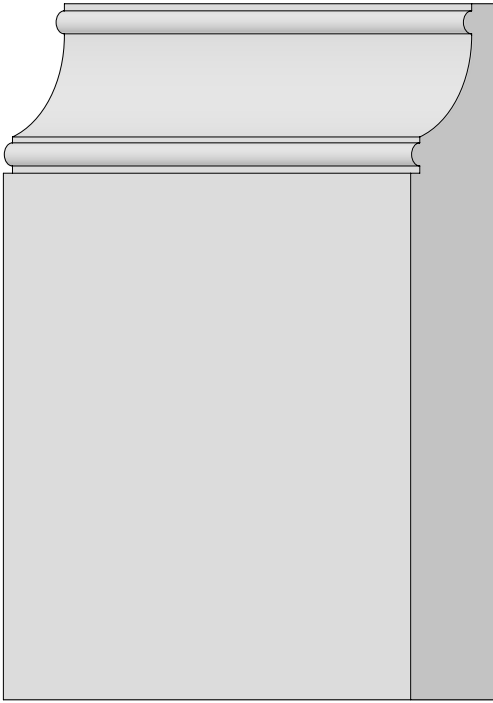

WOBM001
Classical Colonial
1-3/16" x 7-1/4"



WOBM003
Classical Craftsmen
3/4" x 7-1/4"



WOBM001



WOBM003

P FINGER JOINTED & PRIMED	C CLEAR PINE	FP FJ POPLAR DOUBLE PRIMED	W WINDSORONE TRIPLE COAT PRIME	F FLEXIBLE	<input checked="" type="checkbox"/> STOCK
M MEDIUM DENSITY FIBERBOARD	CP CLEAR POPLAR	SP SOLID POPLAR (NO FJ) DOUBLE PRIMED	M METRIE 3 DAY LEAD TIME	V CURVED, PG. 58	NS NON-STOCK AVAILABLE FOR QUICK DELIVERY

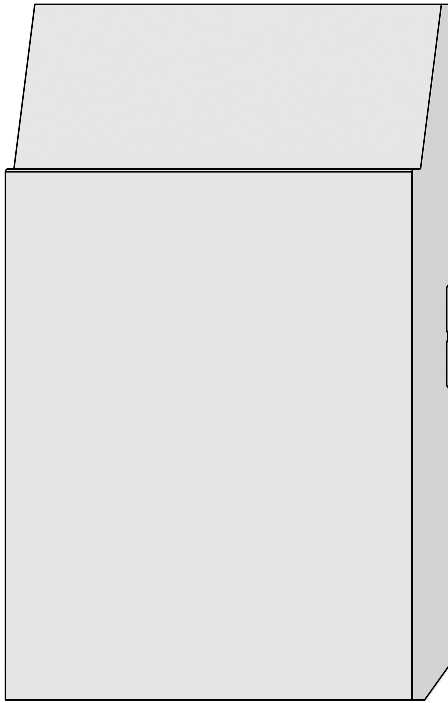

1680232
 Metrie Modern Farmhouse
 9/16" x 7-1/4"

PRIMED
 FJ PINE

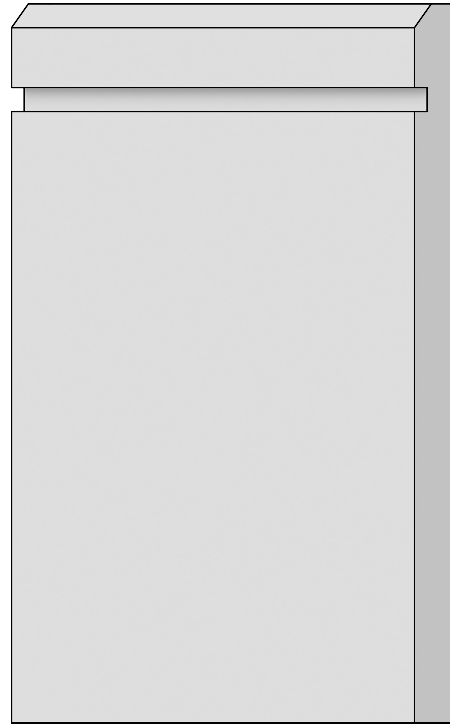

1683734
 Metrie Urban Loft
 9/16" x 7-1/2"

PRIMED
 FJ POPLAR



1680232



1683734

FINGER JOINTED & PRIMED	CLEAR PINE	FJ POPLAR DOUBLE PRIMED	WINDSORONE TRIPLE COAT PRIME	FLEXIBLE	STOCK
MEDIUM DENSITY FIBERBOARD	CLEAR POPLAR	SOLID POPLAR (NO FJ) DOUBLE PRIMED	METRIE 3 DAY LEAD TIME	CURVED, PG. 58	NON-STOCK AVAILABLE FOR QUICK DELIVERY

BASE

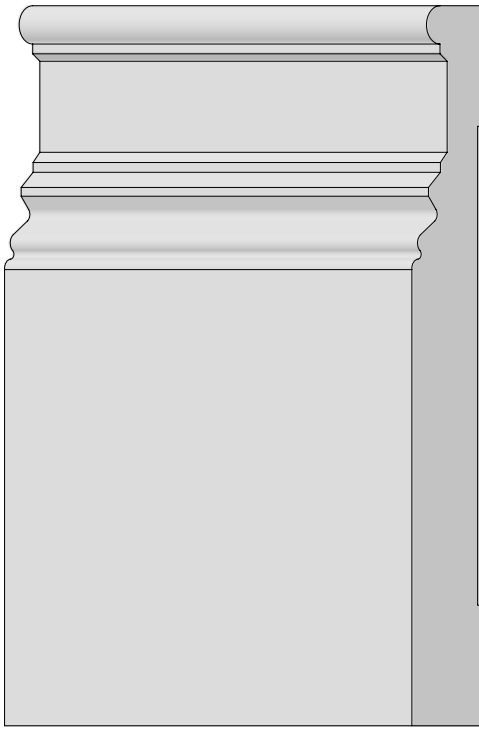

N-1035
1" x 7-1/2"

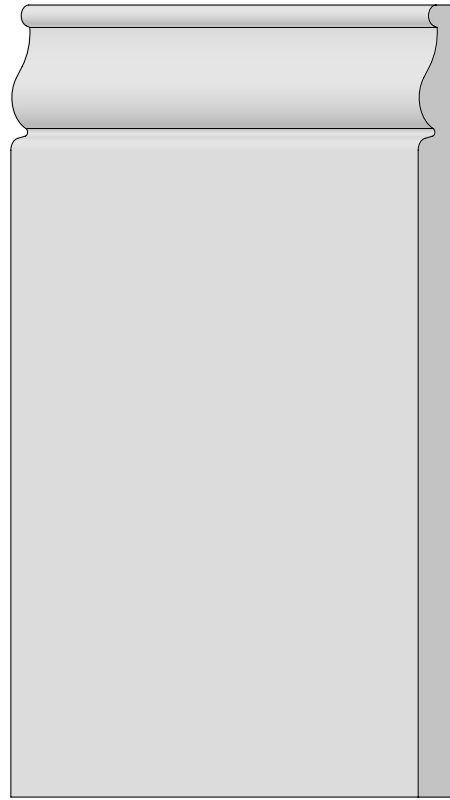

N-526
5/8" x 8-1/4"



N-1035



N-526

P FINGER JOINTED & PRIMED	C CLEAR PINE	FP FJ POPLAR DOUBLE PRIMED	W WINDSORONE TRIPLE COAT PRIME	F FLEXIBLE	<input checked="" type="checkbox"/> STOCK
M MEDIUM DENSITY FIBERBOARD	CP CLEAR POPLAR	SP SOLID POPLAR (NO FJ) DOUBLE PRIMED	M METRIE 3 DAY LEAD TIME	V CURVED, PG. 58	NS NON-STOCK AVAILABLE FOR QUICK DELIVERY

Base Shoe

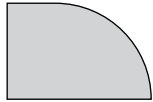

N-63
 1/2" x 3/4"



Plinth

WOPB001
 Plinth Block
 1-3/8" x 8"



P FINGER JOINTED & PRIMED	C CLEAR PINE	FP FJ POPLAR DOUBLE PRIMED	W WINDSORONE TRIPLE COAT PRIME	F FLEXIBLE	<input checked="" type="checkbox"/> STOCK
M MEDIUM DENSITY FIBERBOARD	CP CLEAR POPLAR	SP SOLID POPLAR (NO FJ) DOUBLE PRIMED	M METRIE 3 DAY LEAD TIME	V CURVED, PG. 58	NS NON-STOCK AVAILABLE FOR QUICK DELIVERY

CASING

Casing

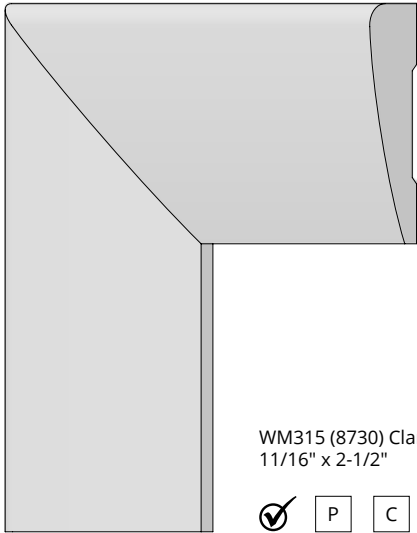

WM315 (8730) Clam
1 1/16" x 2-1/2"

P C

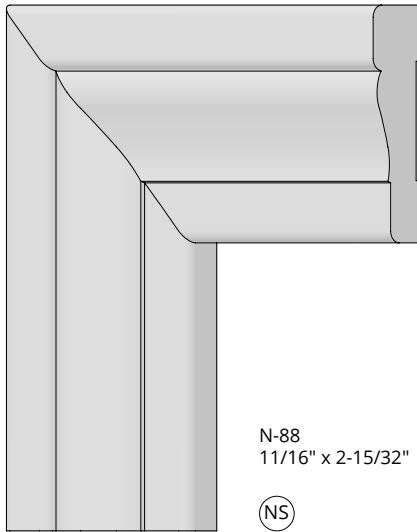
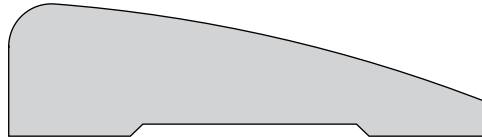

N-88
1 1/16" x 2-15/32"

NS

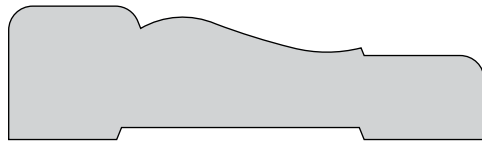

P FINGER JOINTED & PRIMED
 M MEDIUM DENSITY FIBERBOARD

C CLEAR PINE
 CP CLEAR POPLAR

FP FJ POPLAR DOUBLE PRIMED
 SP SOLID POPLAR (NO FJ) DOUBLE PRIMED

W WINDSORONE TRIPLE COAT PRIME
 M METRIE 3 DAY LEAD TIME

F FLEXIBLE
 V CURVED, PG. 58

STOCK
 NS NON-STOCK AVAILABLE FOR QUICK DELIVERY

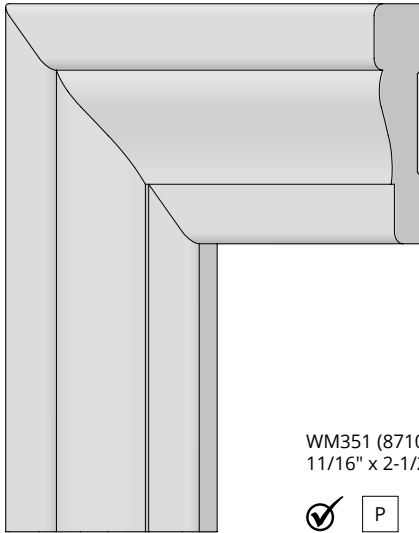

WM351 (8710) Colonial
 1 1/16" x 2-1/2"

P C V

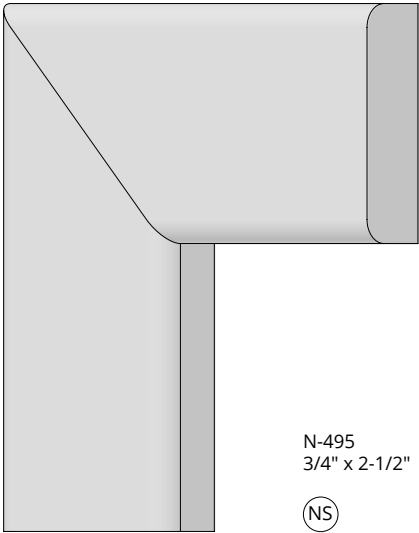
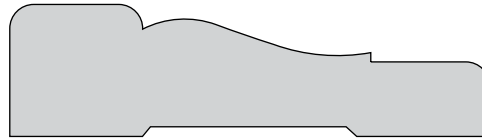

N-495
 3/4" x 2-1/2"

NS



<input type="checkbox"/> P FINGER JOINTED & PRIMED	<input type="checkbox"/> C CLEAR PINE	<input type="checkbox"/> FP FJ POPLAR DOUBLE PRIMED	<input type="checkbox"/> W WINDSORONE TRIPLE COAT PRIME	<input type="checkbox"/> F FLEXIBLE	<input checked="" type="checkbox"/> STOCK
<input type="checkbox"/> M MEDIUM DENSITY FIBERBOARD	<input type="checkbox"/> CP CLEAR POPLAR	<input type="checkbox"/> SP SOLID POPLAR (NO FJ) DOUBLE PRIMED	<input type="checkbox"/> M METRIE 3 DAY LEAD TIME	<input type="checkbox"/> V CURVED, PG. 58	<input type="checkbox"/> NS NON-STOCK AVAILABLE FOR QUICK DELIVERY

CASING

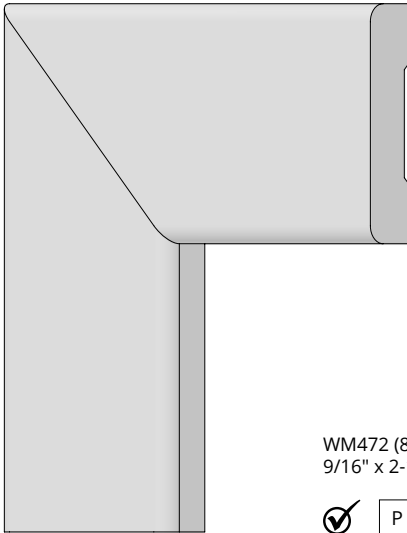

WM472 (8627)
9/16" x 2-1/2"

P C

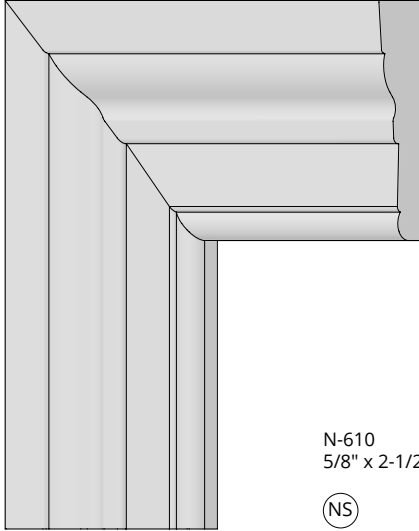

N-610
5/8" x 2-1/2"

NS



P FINGER JOINTED & PRIMED
 M MEDIUM DENSITY FIBERBOARD

C CLEAR PINE
 CP CLEAR POPLAR

FP FJ POPLAR DOUBLE PRIMED
 SP SOLID POPLAR (NO FJ) DOUBLE PRIMED

W WINDSORONE TRIPLE COAT PRIME
 M METRIE 3 DAY LEAD TIME

F FLEXIBLE
 V CURVED, PG. 58

STOCK
 NS NON-STOCK AVAILABLE FOR QUICK DELIVERY



WMBWINDSOR
 Baby Windsor
 3/4" x 2-1/2"

✓ P

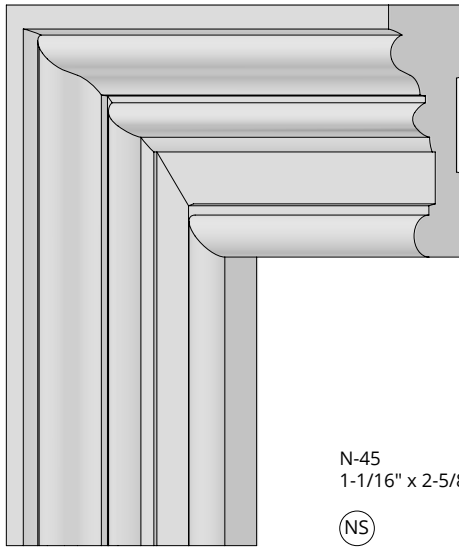
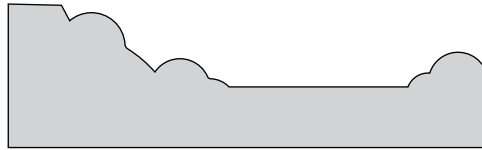

N-45
 1-1/16" x 2-5/8"

NS

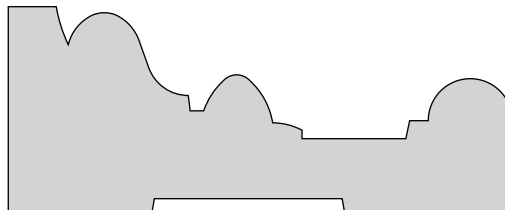

P FINGER JOINTED & PRIMED	C CLEAR PINE	FP FJ POPLAR DOUBLE PRIMED	W WINDSORONE TRIPLE COAT PRIME	F FLEXIBLE	✓ STOCK
M MEDIUM DENSITY FIBERBOARD	CP CLEAR POPLAR	SP SOLID POPLAR (NO FJ) DOUBLE PRIMED	M METRIE 3 DAY LEAD TIME	V CURVED, PG. 58	NS NON-STOCK AVAILABLE FOR QUICK DELIVERY

CASING

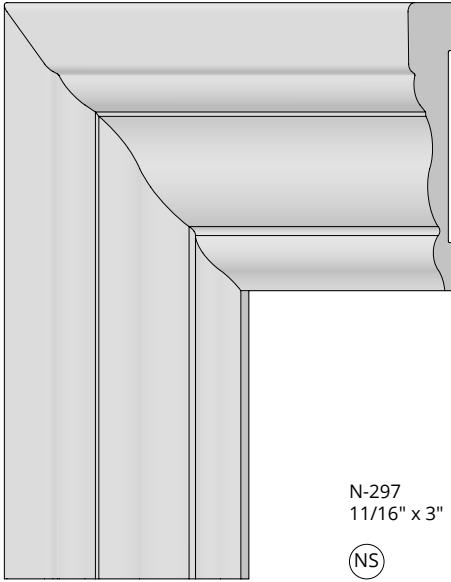

N-297
1 1/16" x 3"

(NS)

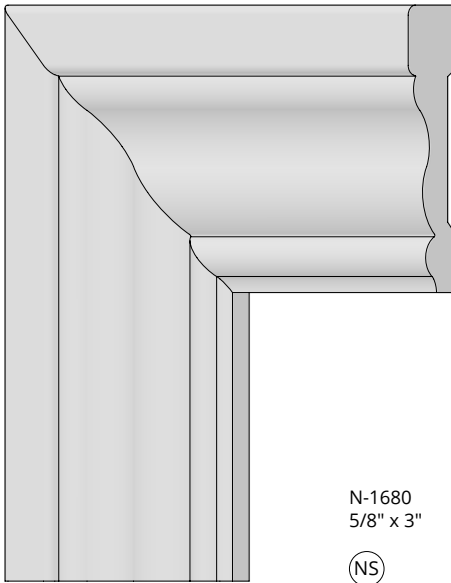
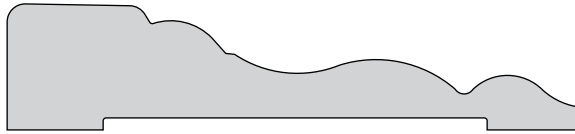

N-1680
5/8" x 3"

(NS)

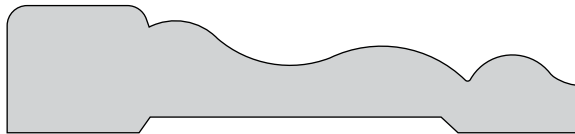

P FINGER JOINTED & PRIMED
M MEDIUM DENSITY FIBERBOARD

C CLEAR PINE
CP CLEAR POPLAR

FP FJ POPLAR DOUBLE PRIMED
SP SOLID POPLAR (NO FJ) DOUBLE PRIMED

W WINDSORONE TRIPLE COAT PRIME
M METRIE 3 DAY LEAD TIME

F FLEXIBLE
V CURVED, PG. 58

✓ STOCK
(NS) NON-STOCK AVAILABLE FOR QUICK DELIVERY

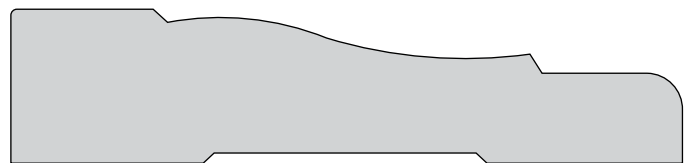
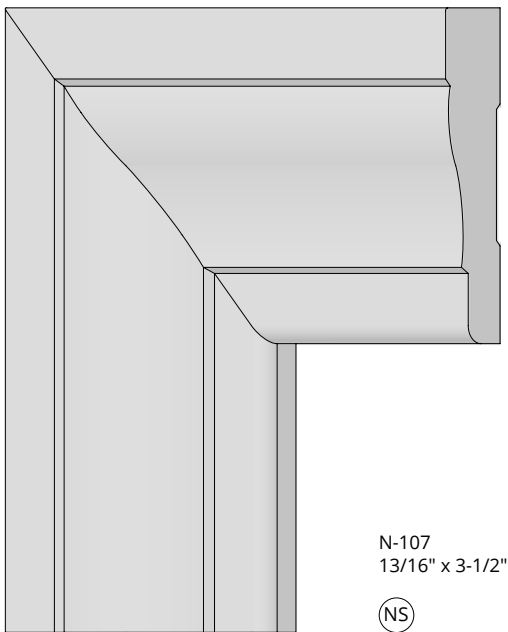
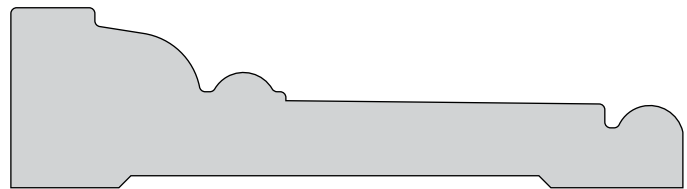
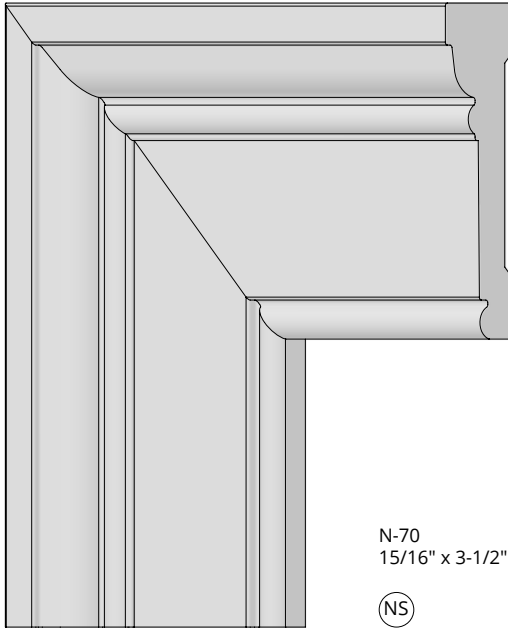

P FINGER JOINTED & PRIMED	C CLEAR PINE	FP FJ POPLAR DOUBLE PRIMED	W WINDSORONE TRIPLE COAT PRIME	F FLEXIBLE	<input checked="" type="checkbox"/> STOCK
M MEDIUM DENSITY FIBERBOARD	CP CLEAR POPLAR	SP SOLID POPLAR (NO FJ) DOUBLE PRIMED	M METRIE 3 DAY LEAD TIME	V CURVED, PG. 58	(NS) NON-STOCK AVAILABLE FOR QUICK DELIVERY

9" SAMPLES AVAILABLE UPON REQUEST. ALL MOULDINGS AVAILABLE IN ANY HARDWOOD OR SOFTWOOD SPECIES WITH SHORT LEAD TIME. AVAILABLE UNFINISHED, DOUBLE PRIMED, CLEAR FINISHED, STAINED OR PAINTED. WE HAVE KNIVES FOR OVER 5,000 PATTERNS AND WE ADD NEW CUSTOM PATTERNS EVERY DAY!

CASING

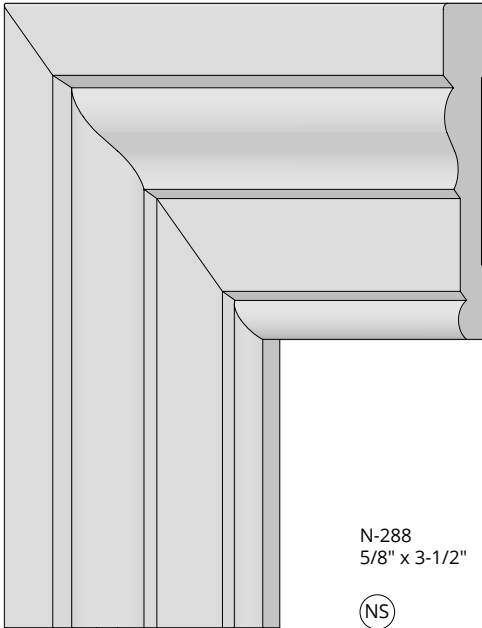

N-288
5/8" x 3-1/2"

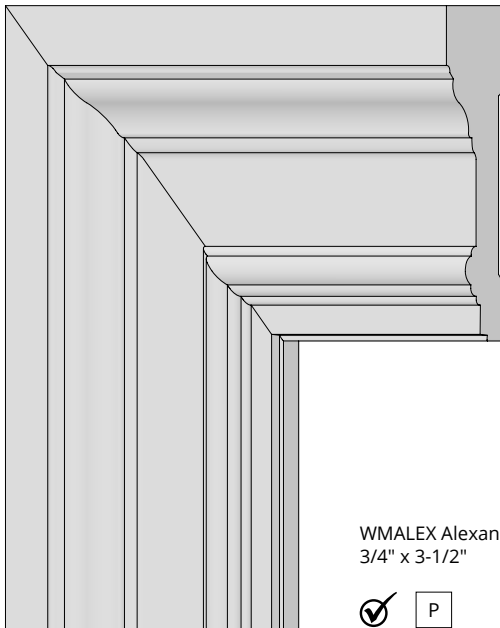
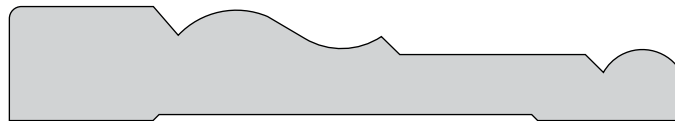

WMALEX Alexandria
3/4" x 3-1/2"

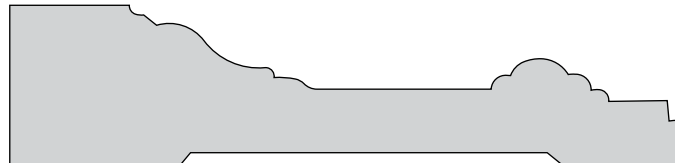

P FINGER JOINTED & PRIMED
M MEDIUM DENSITY FIBERBOARD

C CLEAR PINE
CP CLEAR POPLAR

FP FJ POPLAR DOUBLE PRIMED
SP SOLID POPLAR (NO FJ) DOUBLE PRIMED

W WINDSORONE TRIPLE COAT PRIME
M METRIE 3 DAY LEAD TIME

F FLEXIBLE
V CURVED, PG. 58

✓ STOCK
NS NON-STOCK AVAILABLE FOR QUICK DELIVERY

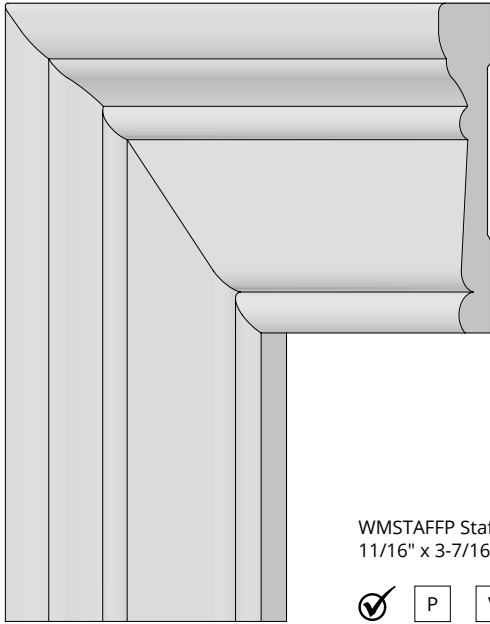

WMSTAFFP Stafford
 1 1/16" x 3-7/16"

P V

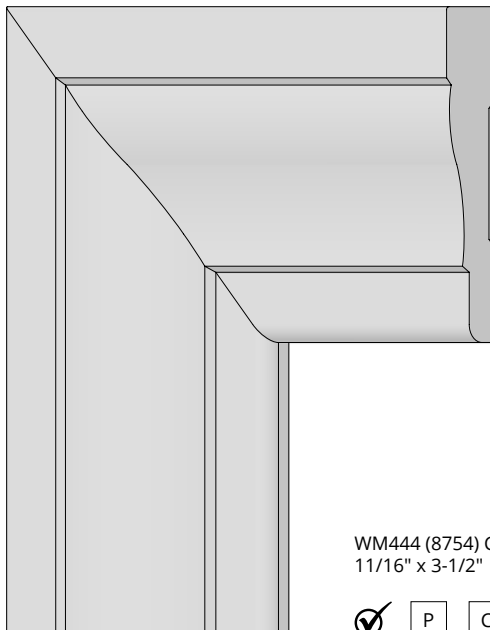
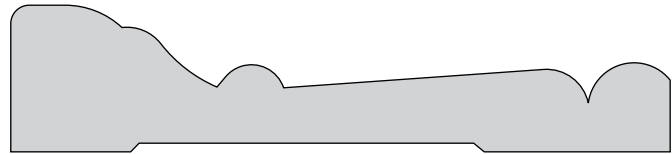

WM444 (8754) Colonial
 1 1/16" x 3-1/2"

P C V



<input type="checkbox"/> P FINGER JOINTED & PRIMED	<input type="checkbox"/> C CLEAR PINE	<input type="checkbox"/> FP FJ POPLAR DOUBLE PRIMED	<input checked="" type="checkbox"/> W WINDSORONE TRIPLE COAT PRIME	<input type="checkbox"/> F FLEXIBLE	<input checked="" type="checkbox"/> STOCK
<input type="checkbox"/> M MEDIUM DENSITY FIBERBOARD	<input type="checkbox"/> CP CLEAR POPLAR	<input type="checkbox"/> SP SOLID POPLAR (NO FJ) DOUBLE PRIMED	<input checked="" type="checkbox"/> M METRIE 3 DAY LEAD TIME	<input type="checkbox"/> V CURVED, PG. 58	<input checked="" type="checkbox"/> NS NON-STOCK AVAILABLE FOR QUICK DELIVERY

CASING

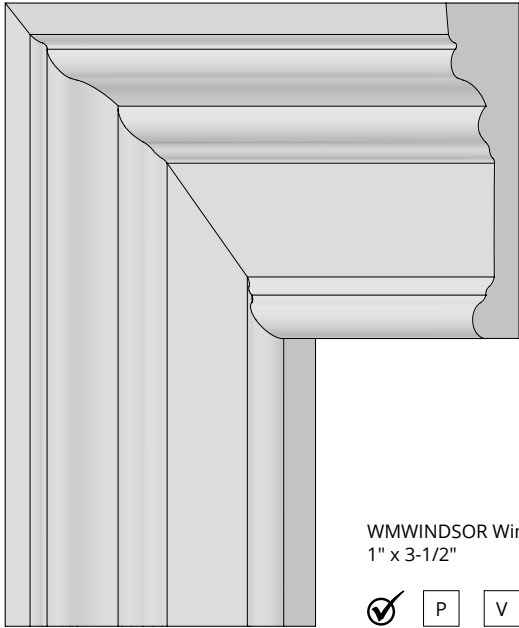

WMWINDSOR Windsor
1" x 3-1/2"

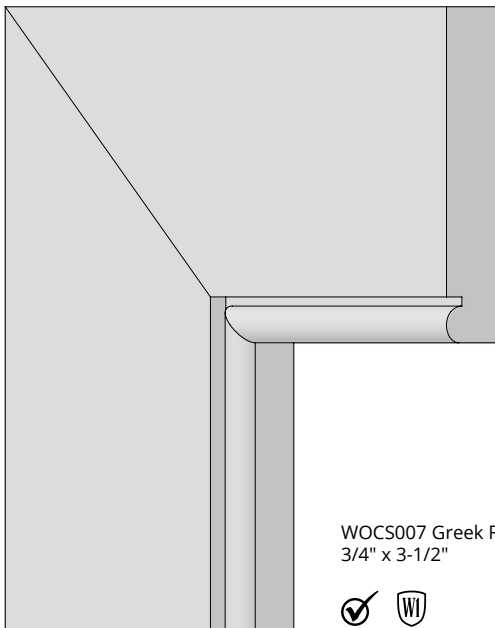
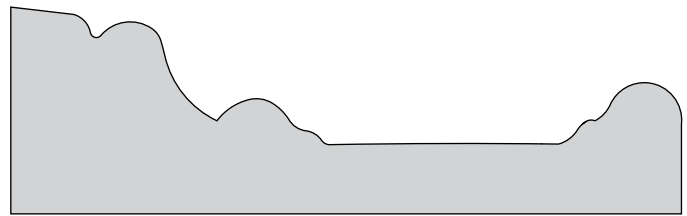

WOCS007 Greek Revival
3/4" x 3-1/2"



P FINGER JOINTED & PRIMED
M MEDIUM DENSITY FIBERBOARD

C CLEAR PINE
CP CLEAR POPLAR

FP FJ POPLAR DOUBLE PRIMED
SP SOLID POPLAR (NO FJ) DOUBLE PRIMED

W WINDSORONE TRIPLE COAT PRIME
M METRIE 3 DAY LEAD TIME

F FLEXIBLE
V CURVED, PG. 58

✓ STOCK
NS NON-STOCK AVAILABLE FOR QUICK DELIVERY

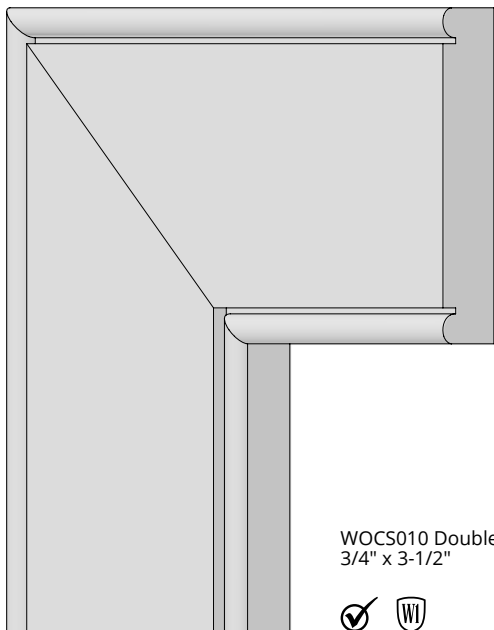

WPCS010 Double Bead
 3/4" x 3-1/2"

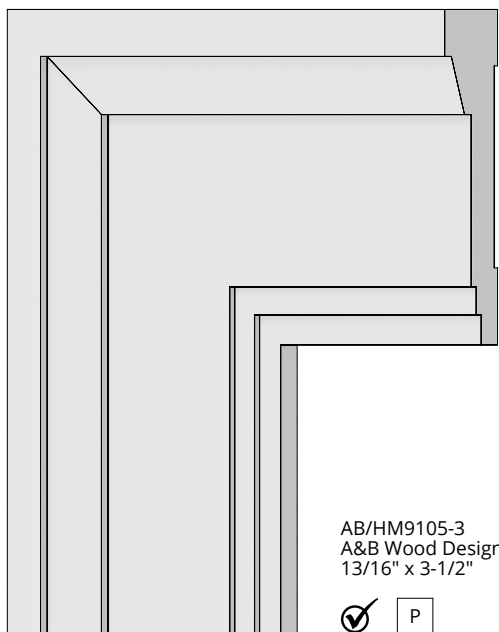

AB/HM9105-3
 A&B Wood Design
 13/16" x 3-1/2"

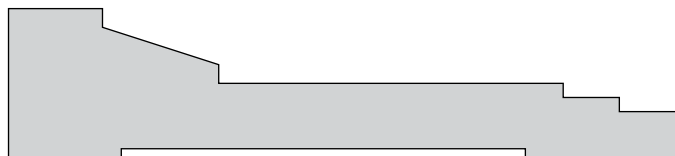

P FINGER JOINTED & PRIMED	C CLEAR PINE	FP FJ POPLAR DOUBLE PRIMED	W WINDSORONE TRIPLE COAT PRIME	F FLEXIBLE	<input checked="" type="checkbox"/> STOCK
M MEDIUM DENSITY FIBERBOARD	CP CLEAR POPLAR	SP SOLID POPLAR (NO FJ) DOUBLE PRIMED	M METRIE 3 DAY LEAD TIME	V CURVED, PG. 58	NS NON-STOCK AVAILABLE FOR QUICK DELIVERY

CASING

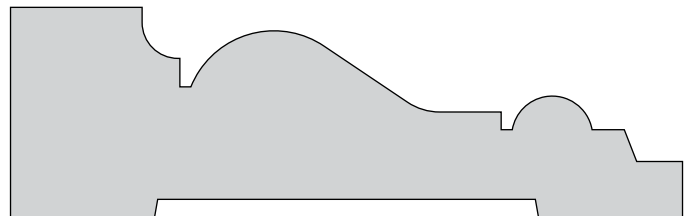
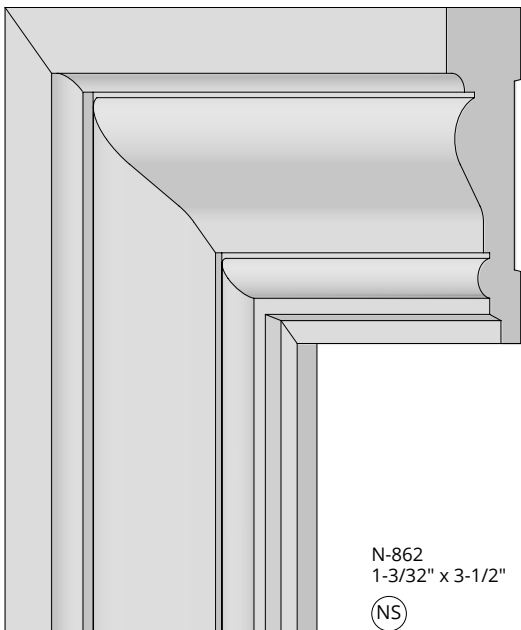
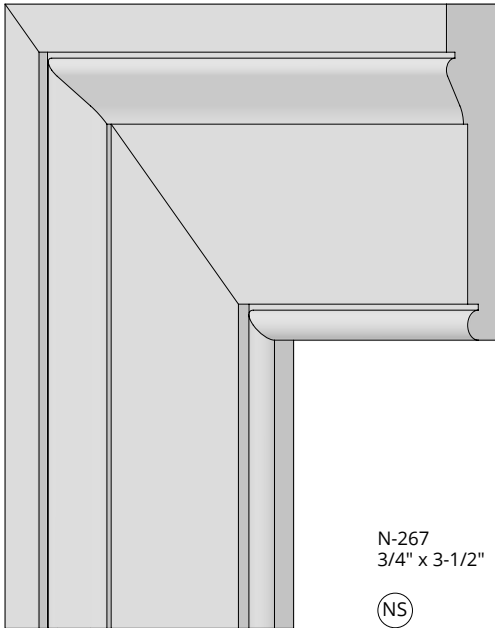

P FINGER JOINTED & PRIMED
M MEDIUM DENSITY FIBERBOARD

C CLEAR PINE
CP CLEAR POPLAR

FP FJ POPLAR DOUBLE PRIMED
SP SOLID POPLAR (NO FJ) DOUBLE PRIMED

W WINDSORONE TRIPLE COAT PRIME
M METRIE 3 DAY LEAD TIME

F FLEXIBLE
V CURVED, PG. 58

✓ STOCK
(NS) NON-STOCK AVAILABLE FOR QUICK DELIVERY

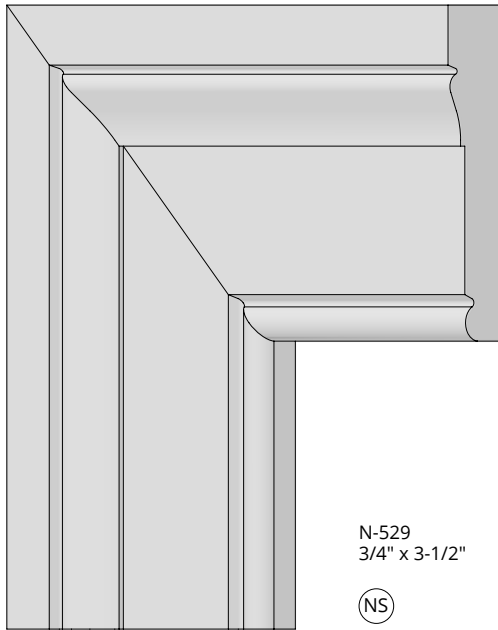

N-529
 3/4" x 3-1/2"

(NS)

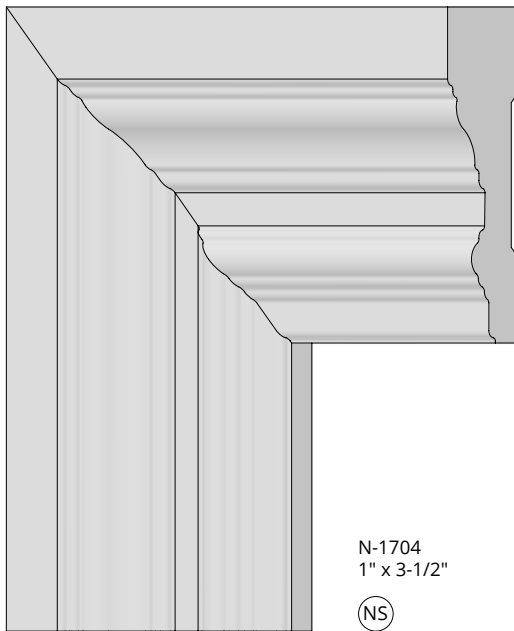

N-1704
 1" x 3-1/2"

(NS)

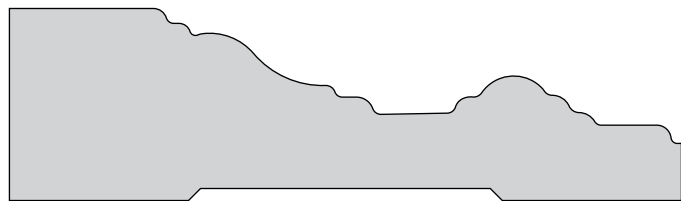

P FINGER JOINTED & PRIMED	C CLEAR PINE	FP FJ POPLAR DOUBLE PRIMED	W WINDSORONE TRIPLE COAT PRIME	F FLEXIBLE	<input checked="" type="checkbox"/> STOCK
M MEDIUM DENSITY FIBERBOARD	CP CLEAR POPLAR	SP SOLID POPLAR (NO FJ) DOUBLE PRIMED	M METRIE 3 DAY LEAD TIME	V CURVED, PG. 58	(NS) NON-STOCK AVAILABLE FOR QUICK DELIVERY

CASING

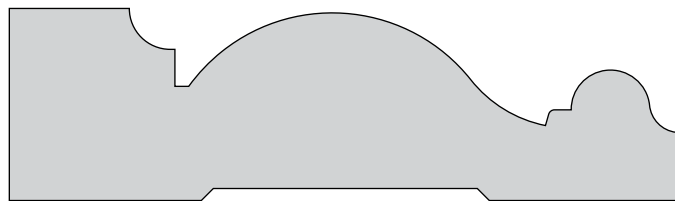
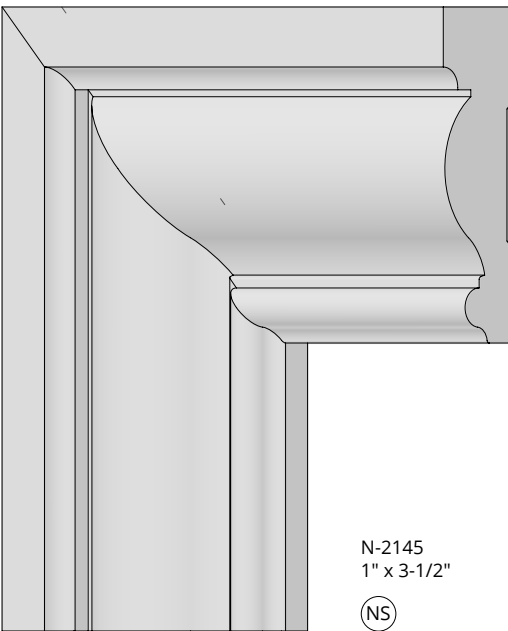
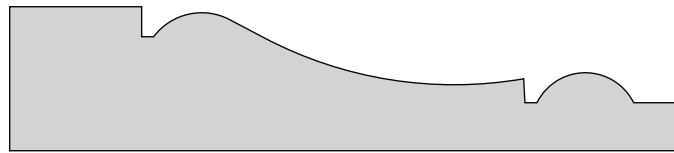
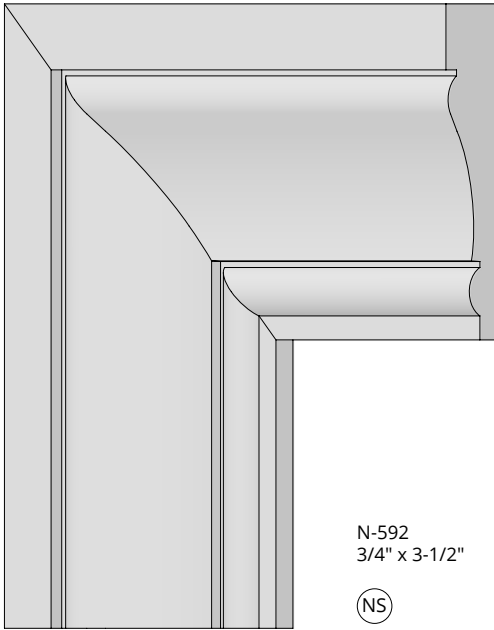

P FINGER JOINTED & PRIMED	C CLEAR PINE	FP FJ POPLAR DOUBLE PRIMED	W WINDSORONE TRIPLE COAT PRIME	F FLEXIBLE	<input checked="" type="checkbox"/> STOCK
M MEDIUM DENSITY FIBERBOARD	CP CLEAR POPLAR	SP SOLID POPLAR (NO FJ) DOUBLE PRIMED	M METRIE 3 DAY LEAD TIME	V CURVED, PG. 58	NS NON-STOCK AVAILABLE FOR QUICK DELIVERY

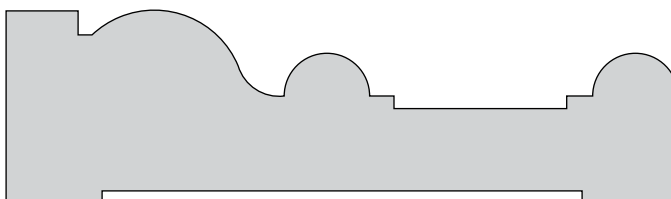
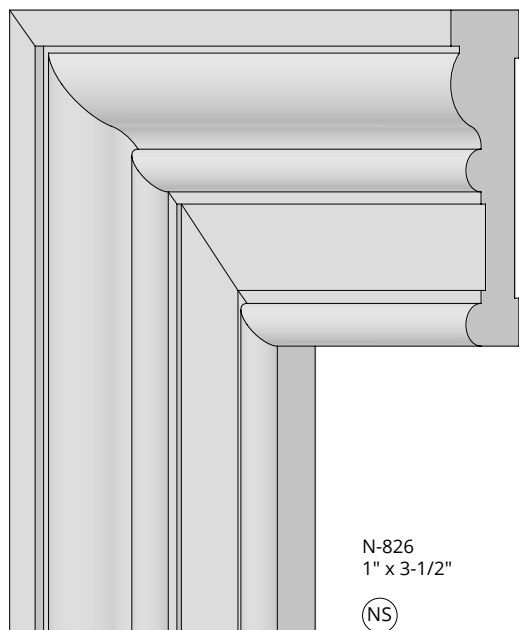
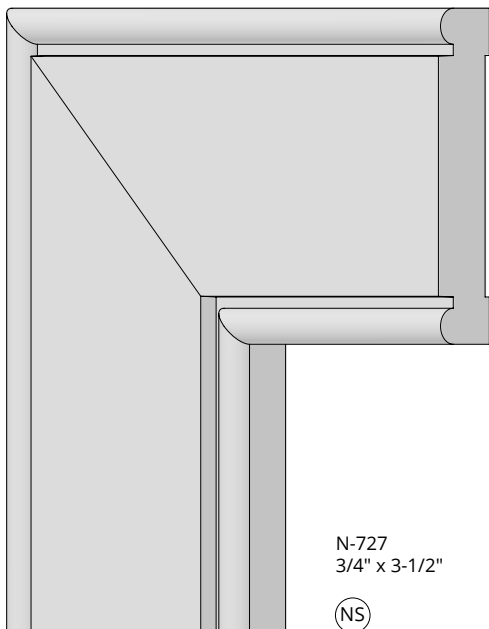

P FINGER JOINTED & PRIMED	C CLEAR PINE	FP FJ POPLAR DOUBLE PRIMED	W WINDSORONE TRIPLE COAT PRIME	F FLEXIBLE	<input checked="" type="checkbox"/> STOCK
M MEDIUM DENSITY FIBERBOARD	CP CLEAR POPLAR	SP SOLID POPLAR (NO FJ) DOUBLE PRIMED	M METRIE 3 DAY LEAD TIME	V CURVED, PG. 58	(NS) NON-STOCK AVAILABLE FOR QUICK DELIVERY

CASING

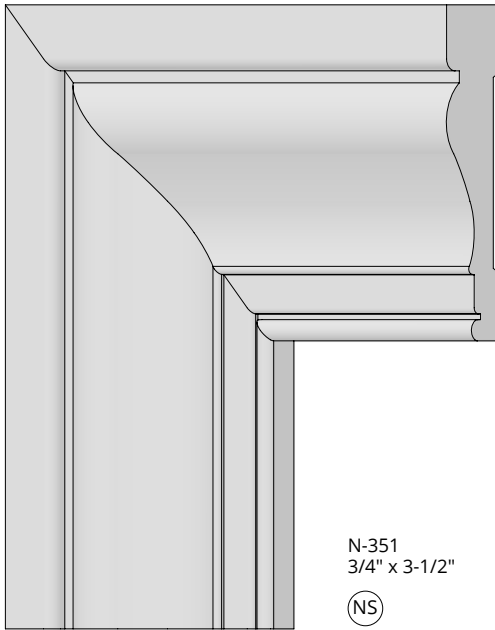

N-351
3/4" x 3-1/2"

(NS)

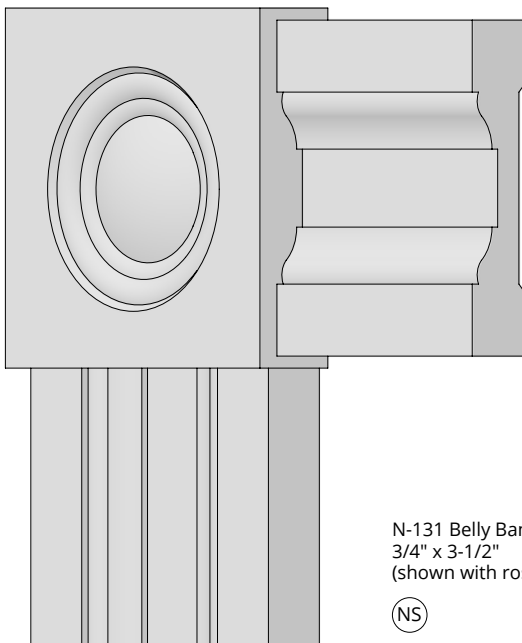
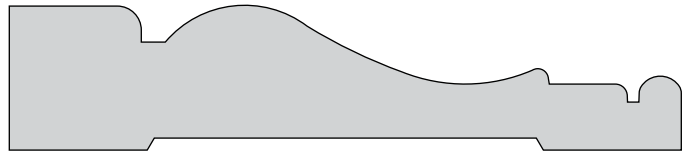

N-131 Belly Band
3/4" x 3-1/2"
(shown with rosette)

(NS)

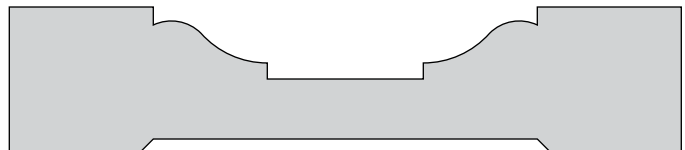

P FINGER JOINTED & PRIMED
M MEDIUM DENSITY FIBERBOARD

C CLEAR PINE
CP CLEAR POPLAR

FP FJ POPLAR DOUBLE PRIMED
SP SOLID POPLAR (NO FJ) DOUBLE PRIMED

W WINDSORONE TRIPLE COAT PRIME
M METRIE 3 DAY LEAD TIME

F FLEXIBLE
V CURVED, PG. 58

✓ STOCK
(NS) NON-STOCK AVAILABLE FOR QUICK DELIVERY

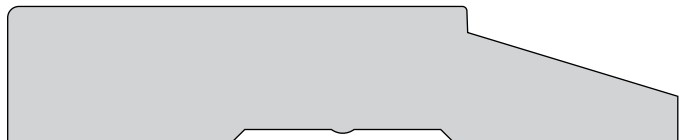
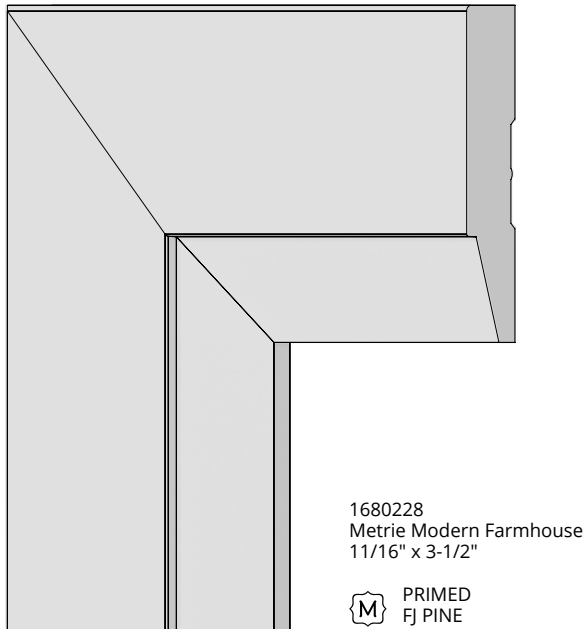
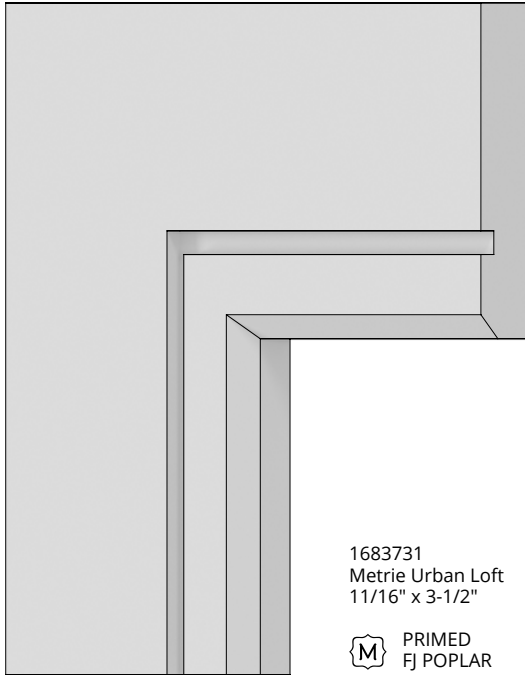

FINGER JOINTED & PRIMED	CLEAR PINE	FJ POPLAR DOUBLE PRIMED	WINDSORONE TRIPLE COAT PRIME	FLEXIBLE	STOCK
MEDIUM DENSITY FIBERBOARD	CLEAR POPLAR	SOLID POPLAR (NO FJ) DOUBLE PRIMED	METRIE 3 DAY LEAD TIME	CURVED, PG. 58	NON-STOCK AVAILABLE FOR QUICK DELIVERY

CASING

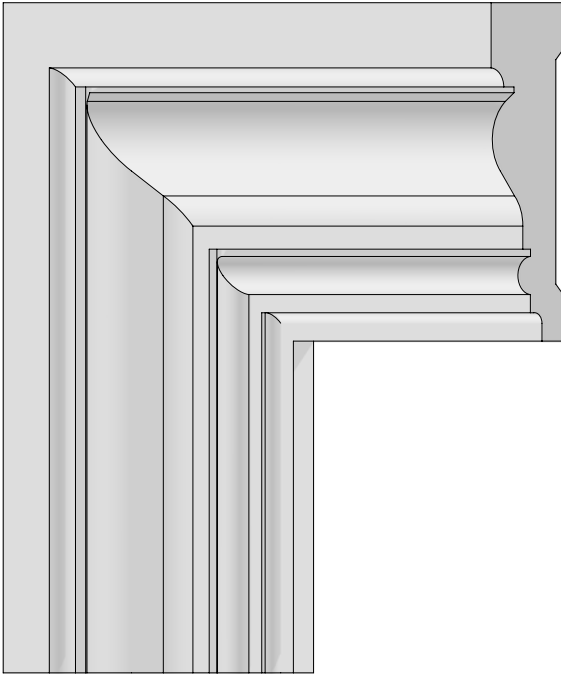

N-1690
1-1/32" x 3-17/32"

(NS)

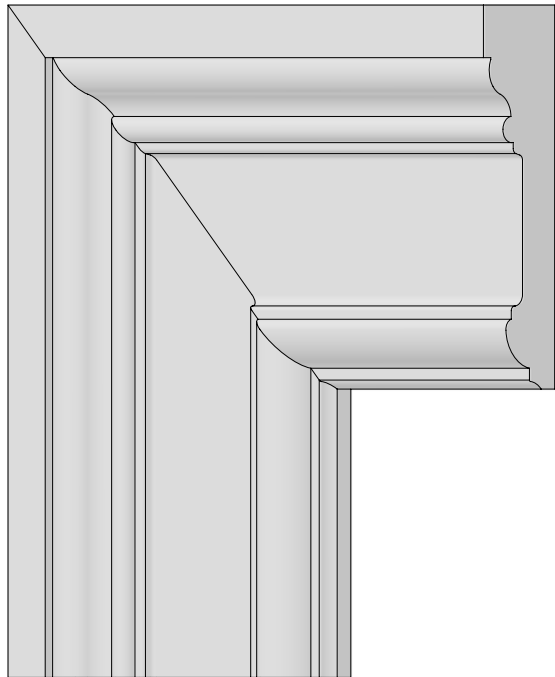
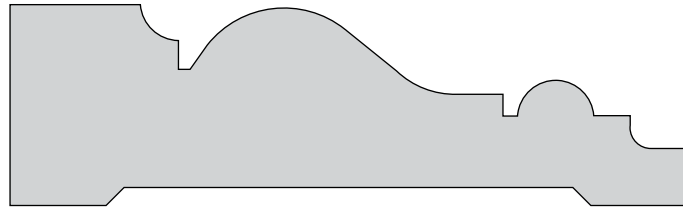

N-910
1-1/16" x 4"

(NS)

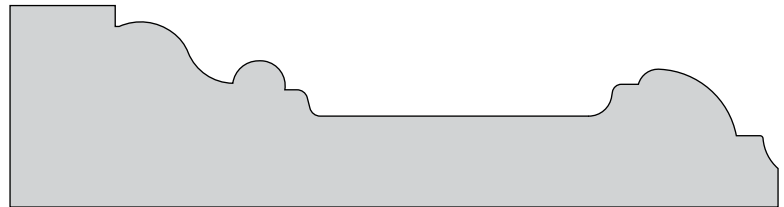

P FINGER JOINTED & PRIMED
M MEDIUM DENSITY FIBERBOARD

C CLEAR PINE
CP CLEAR POPLAR

FP FJ POPLAR DOUBLE PRIMED
SP SOLID POPLAR (NO FJ) DOUBLE PRIMED

W WINDSORONE TRIPLE COAT PRIME
M METRIE 3 DAY LEAD TIME

F FLEXIBLE
V CURVED, PG. 58

STOCK
(NS) NON-STOCK AVAILABLE FOR QUICK DELIVERY

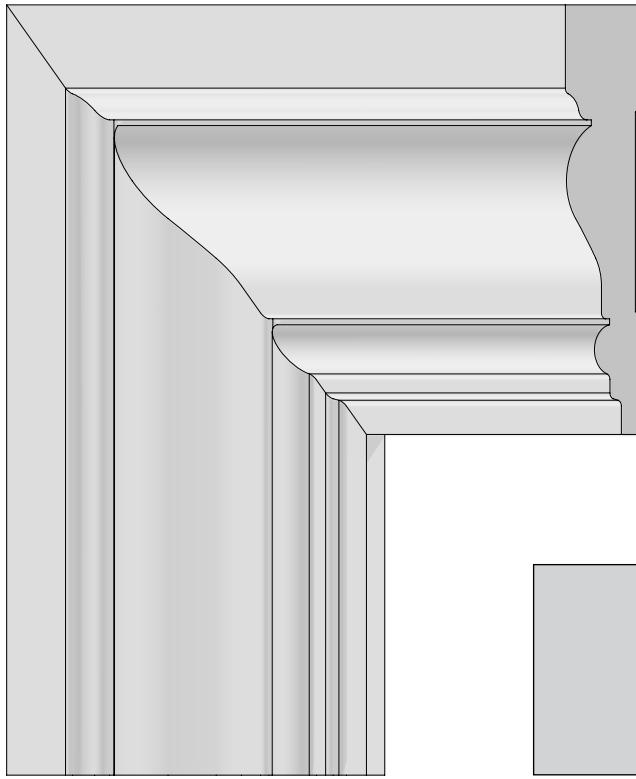

N-3394
 1-3/32" x 4-15/32"

(NS)

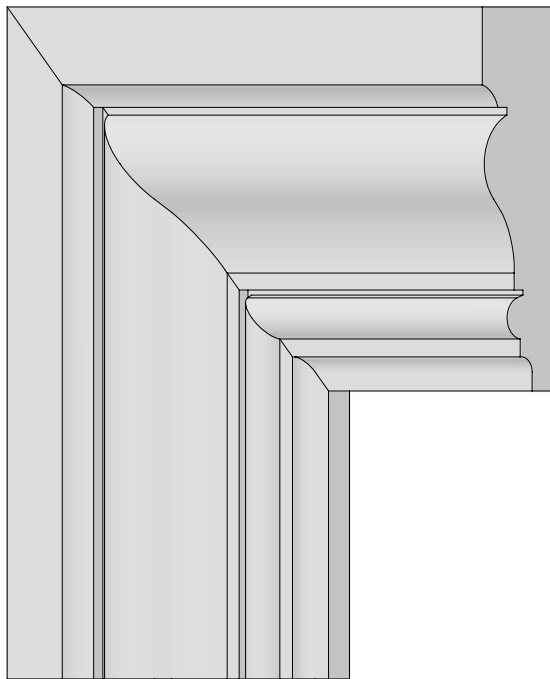
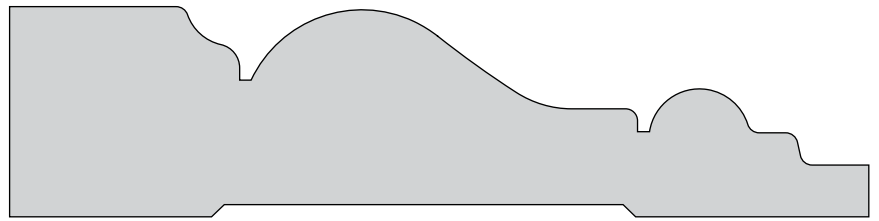

N-1691
 1" x 4"

(NS)

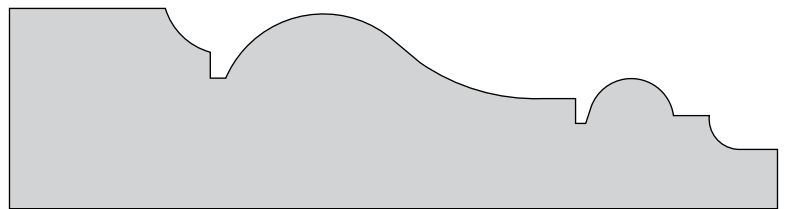

P FINGER JOINTED & PRIMED	C CLEAR PINE	FP FJ POPLAR DOUBLE PRIMED	W WINDSORONE TRIPLE COAT PRIME	F FLEXIBLE	<input checked="" type="checkbox"/> STOCK
M MEDIUM DENSITY FIBERBOARD	CP CLEAR POPLAR	SP SOLID POPLAR (NO FJ) DOUBLE PRIMED	M METRIE 3 DAY LEAD TIME	V CURVED, PG. 58	(NS) NON-STOCK AVAILABLE FOR QUICK DELIVERY

9" SAMPLES AVAILABLE UPON REQUEST. ALL MOULDINGS AVAILABLE IN ANY HARDWOOD OR SOFTWOOD SPECIES WITH SHORT LEAD TIME. AVAILABLE UNFINISHED, DOUBLE PRIMED, CLEAR FINISHED, STAINED OR PAINTED. WE HAVE KNIVES FOR OVER 5,000 PATTERNS AND WE ADD NEW CUSTOM PATTERNS EVERY DAY!

CASING

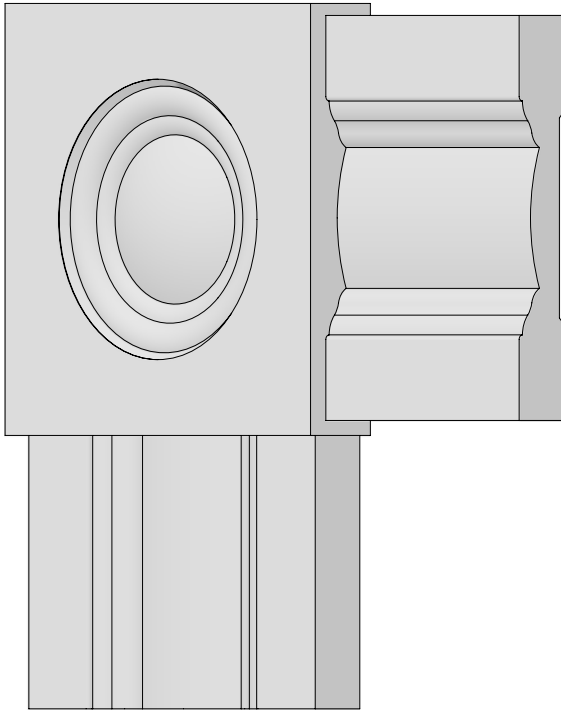

WMB100 Belly Band
1 1/16" x 4-1/4"
(shown with rosette)

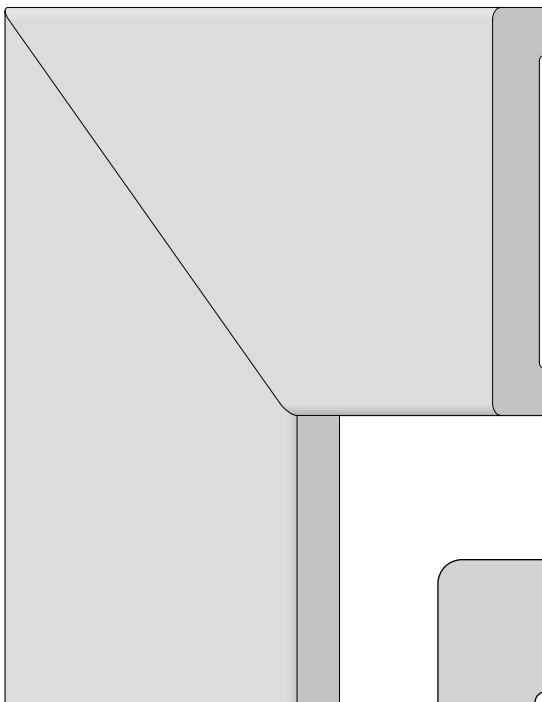

WOC5003
Classical Craftsmen
3/4" x 4-1/4"



P FINGER JOINTED & PRIMED
M MEDIUM DENSITY FIBERBOARD

C CLEAR PINE
CP CLEAR POPLAR

FP FJ POPLAR DOUBLE PRIMED
SP SOLID POPLAR (NO FJ) DOUBLE PRIMED

W WINDSORONE TRIPLE COAT PRIME
M METRIE 3 DAY LEAD TIME

F FLEXIBLE
V CURVED, PG. 58

✓ STOCK
NS NON-STOCK AVAILABLE FOR QUICK DELIVERY

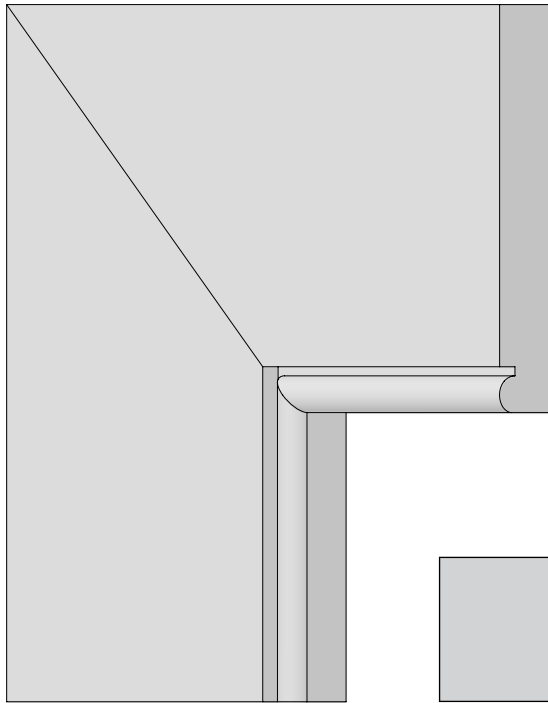

WOC5008
 Beaded
 3/4" x 4-1/4"

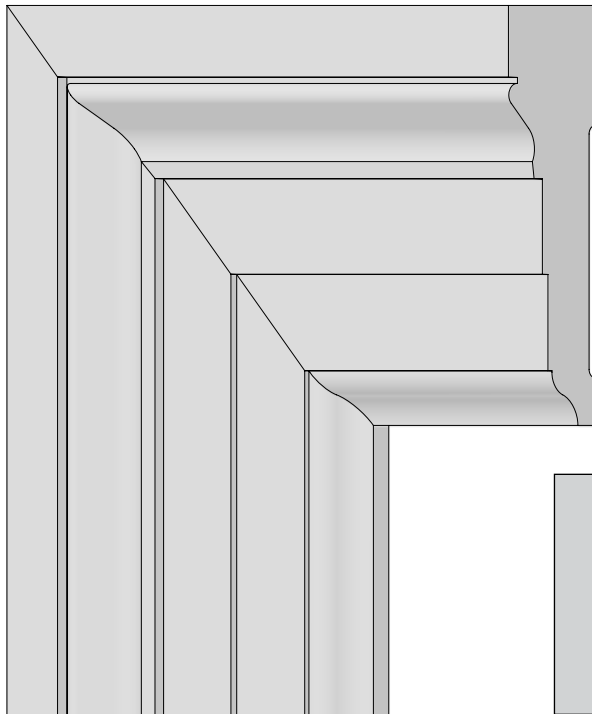

WOC5005
 Colonial Revival
 1-3/16" x 4-3/8"

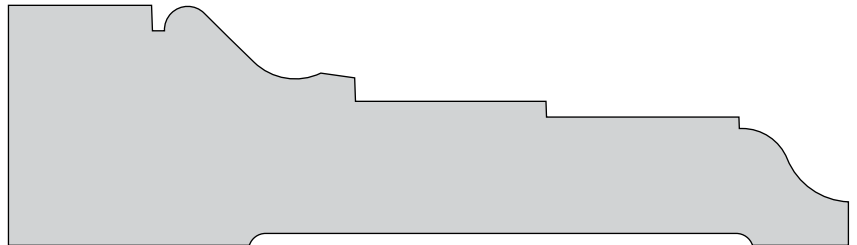

P FINGER JOINTED & PRIMED	C CLEAR PINE	FP FJ POPLAR DOUBLE PRIMED	W WINDSORONE TRIPLE COAT PRIME	F FLEXIBLE	<input checked="" type="checkbox"/> STOCK
M MEDIUM DENSITY FIBERBOARD	CP CLEAR POPLAR	SP SOLID POPLAR (NO FJ) DOUBLE PRIMED	M METRIE 3 DAY LEAD TIME	V CURVED, PG. 58	<input type="checkbox"/> NON-STOCK AVAILABLE FOR QUICK DELIVERY

CASING

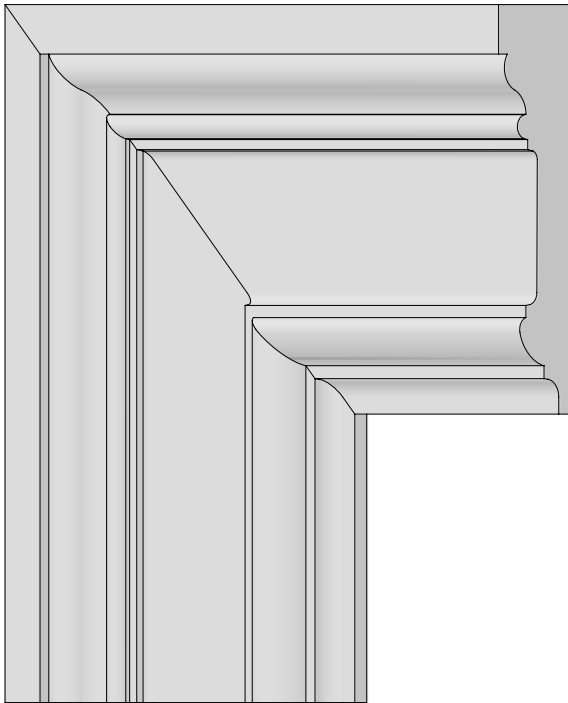

N-396
1-1/16" x 4-9/32"

(NS)

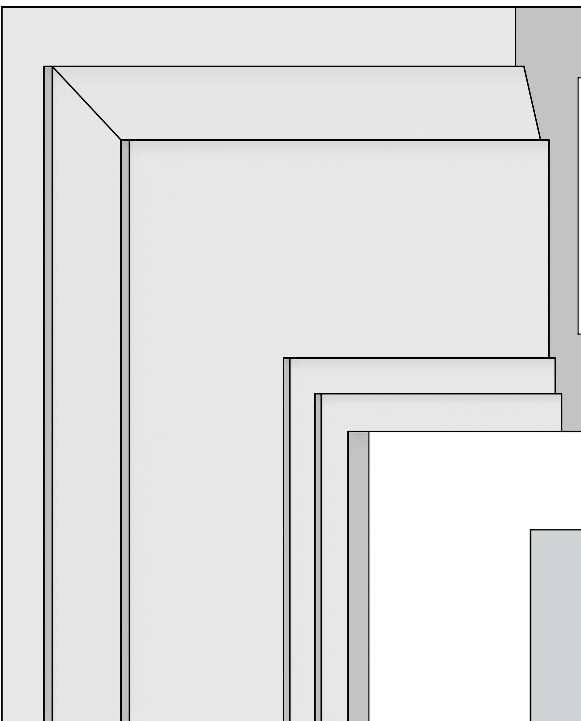

AB/HM9105
A&B Wood Design
1" x 4-15/32"

✓ P

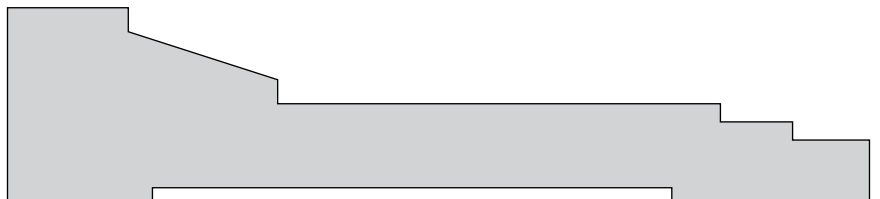

P FINGER JOINTED & PRIMED
M MEDIUM DENSITY FIBERBOARD

C CLEAR PINE
CP CLEAR POPLAR

FP FJ POPLAR DOUBLE PRIMED
SP SOLID POPLAR (NO FJ) DOUBLE PRIMED

W WINDSORONE TRIPLE COAT PRIME
M METRIE 3 DAY LEAD TIME

F FLEXIBLE
V CURVED, PG. 58

✓ **STOCK**
(NS) NON-STOCK AVAILABLE FOR QUICK DELIVERY

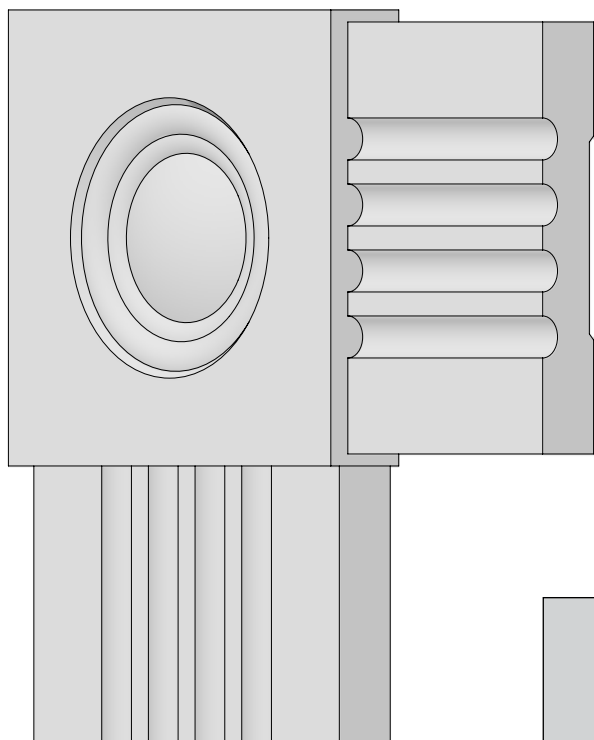

N-15
 3/4" x 4-1/2"
 (shown with rosette)

(NS)

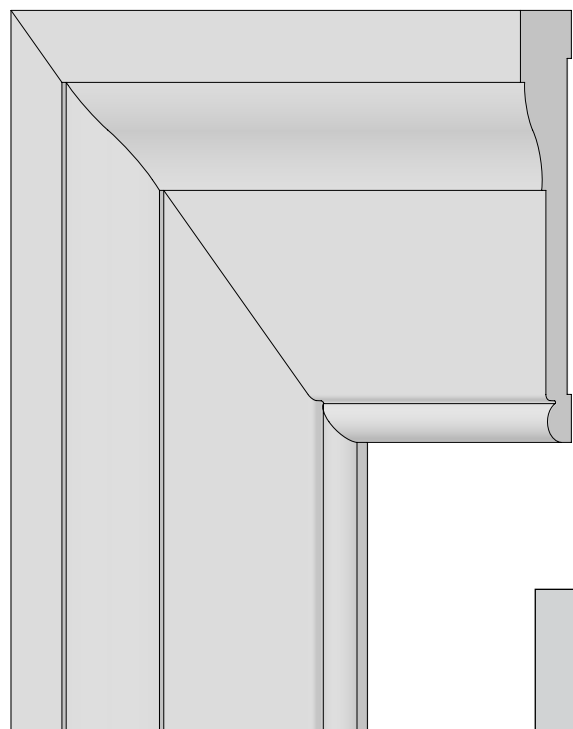
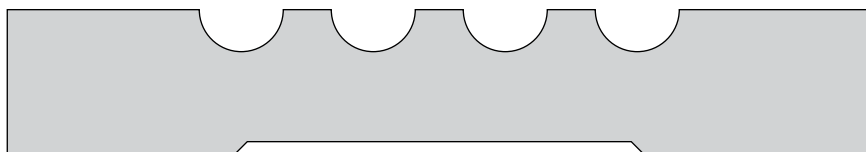

N-106
 3/4" x 4-1/2"

(NS)

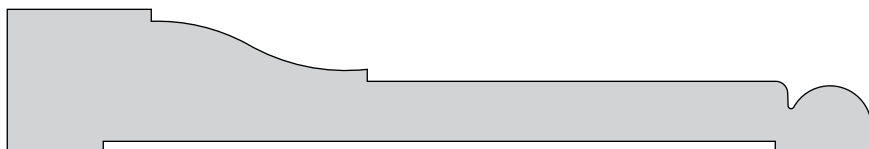

P FINGER JOINTED & PRIMED	C CLEAR PINE	FP FJ POPLAR DOUBLE PRIMED	W WINDSORONE TRIPLE COAT PRIME	F FLEXIBLE	<input checked="" type="checkbox"/> STOCK
M MEDIUM DENSITY FIBERBOARD	CP CLEAR POPLAR	SP SOLID POPLAR (NO FJ) DOUBLE PRIMED	M METRIE 3 DAY LEAD TIME	V CURVED, PG. 58	(NS) NON-STOCK AVAILABLE FOR QUICK DELIVERY

CASING

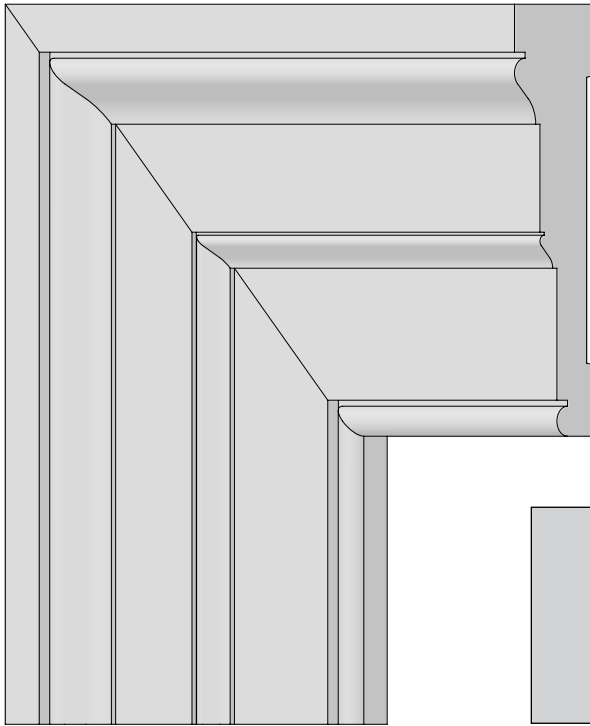

N-268
1-1/8" x 4-1/2"

NS

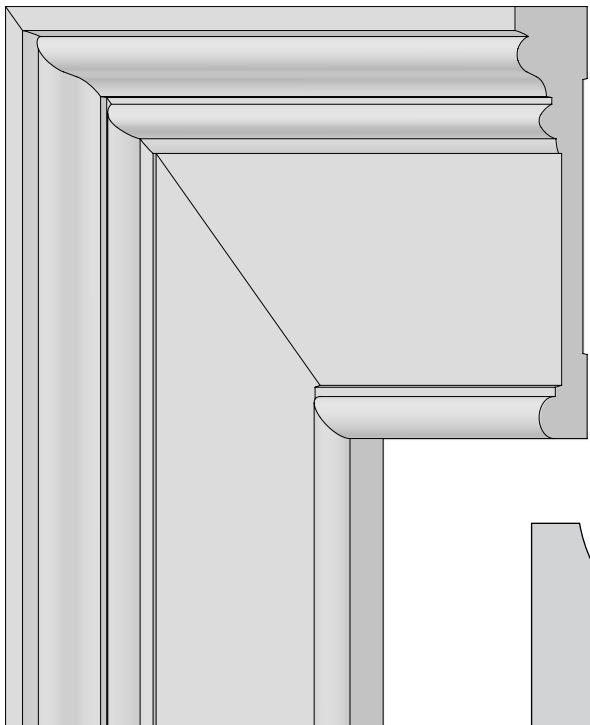
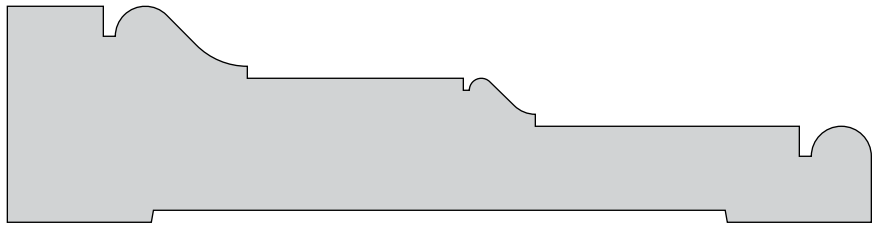

N-404
1-1/16" x 4-1/2"

✓ FP

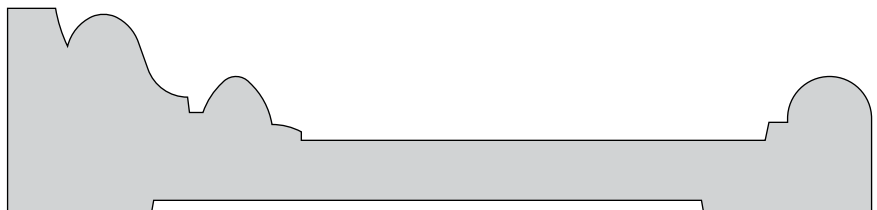

P FINGER JOINTED & PRIMED
M MEDIUM DENSITY FIBERBOARD

C CLEAR PINE
CP CLEAR POPLAR

FP FJ POPLAR DOUBLE PRIMED
SP SOLID POPLAR (NO FJ) DOUBLE PRIMED

W WINDSORONE TRIPLE COAT PRIME
M METRIE 3 DAY LEAD TIME

F FLEXIBLE
V CURVED, PG. 58

✓ **STOCK**
NS **NON-STOCK AVAILABLE FOR QUICK DELIVERY**

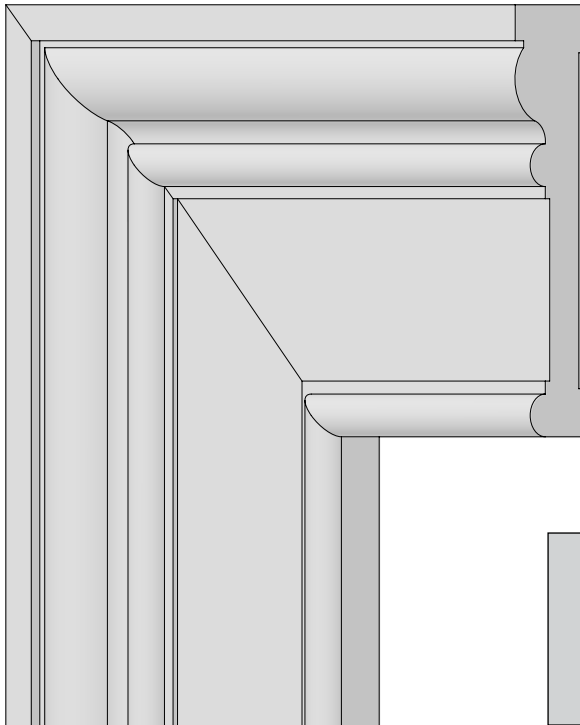

N-825
 1" x 4-1/2"

(NS)

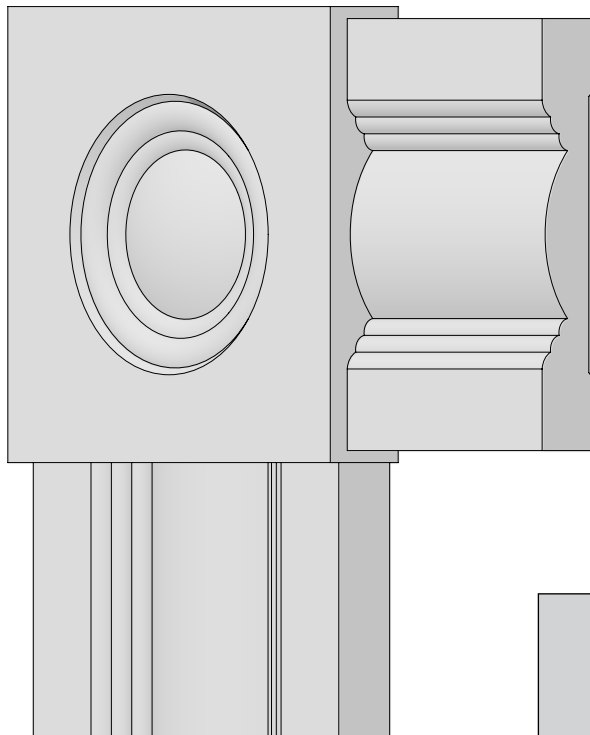
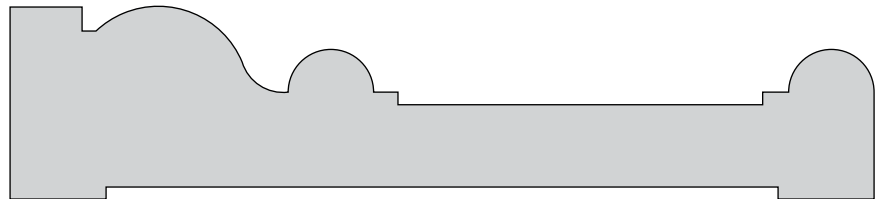

N-8 Belly Band
 3/4" x 4-1/2"
 (shown with rosette)

(NS)

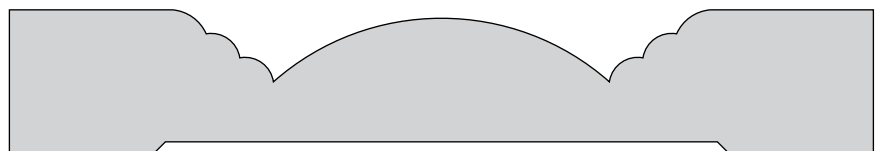

P FINGER JOINTED & PRIMED	C CLEAR PINE	FP FJ POPLAR DOUBLE PRIMED	W WINDSORONE TRIPLE COAT PRIME	F FLEXIBLE	<input checked="" type="checkbox"/> STOCK
M MEDIUM DENSITY FIBERBOARD	CP CLEAR POPLAR	SP SOLID POPLAR (NO FJ) DOUBLE PRIMED	M METRIE 3 DAY LEAD TIME	V CURVED, PG. 58	(NS) NON-STOCK AVAILABLE FOR QUICK DELIVERY

CASING

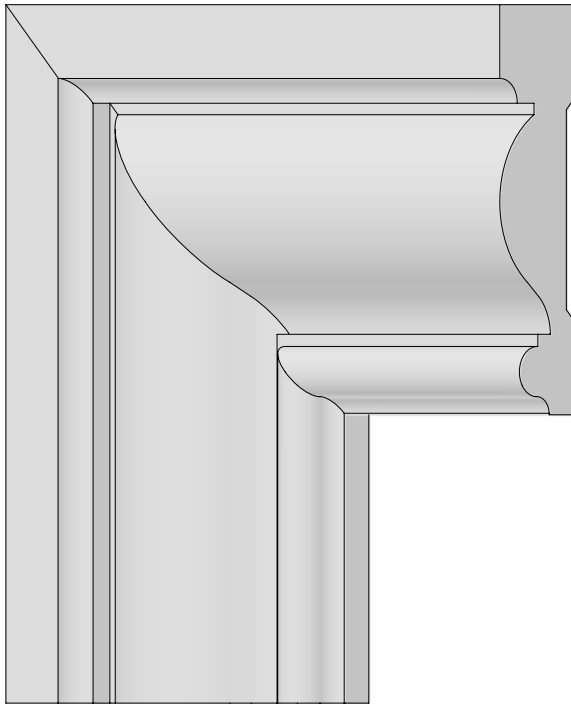

N-1686
1-1/16" x 4-9/32"

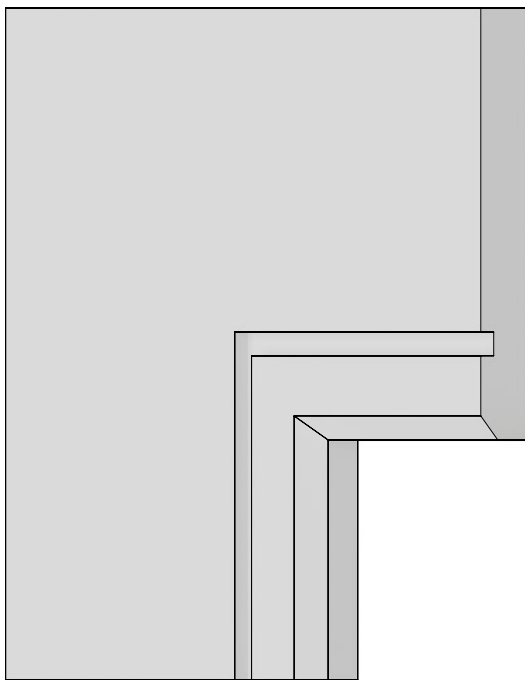
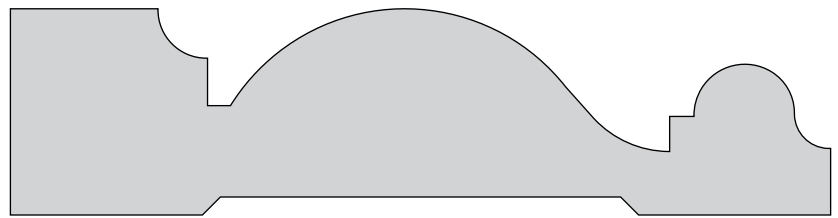

1683732
Metrie Urban Loft
1 1/16" x 4-1/2"

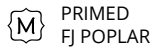

P FINGER JOINTED & PRIMED
M MEDIUM DENSITY FIBERBOARD

C CLEAR PINE
CP CLEAR POPLAR

FP FJ POPLAR DOUBLE PRIMED
SP SOLID POPLAR (NO FJ) DOUBLE PRIMED

W WINDSORONE TRIPLE COAT PRIME
M METRIE 3 DAY LEAD TIME

F FLEXIBLE
V CURVED, PG. 58

✓ STOCK
NS NON-STOCK AVAILABLE FOR QUICK DELIVERY

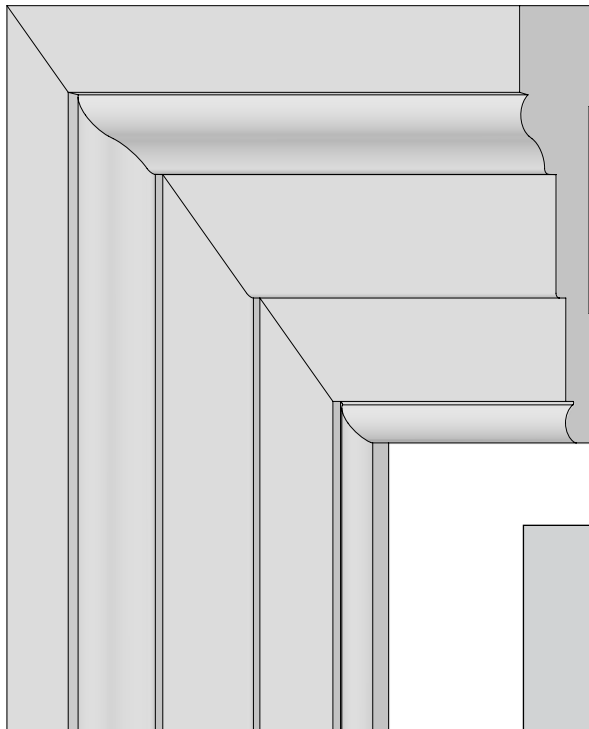

N-672
 1-1/16" x 4-9/16"

(NS)

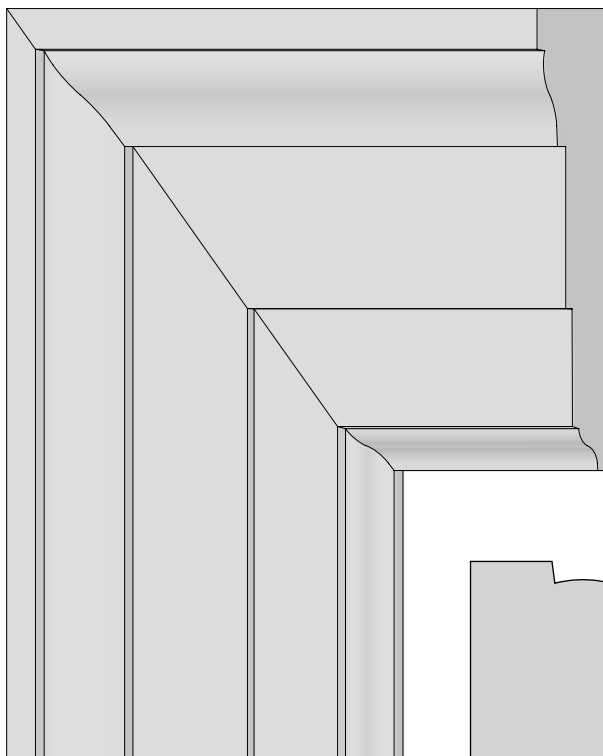
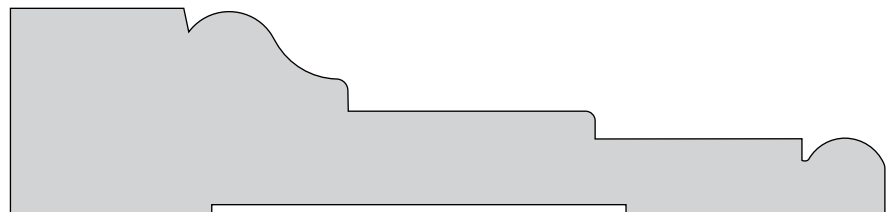

N-338
 1-1/16" x 4-13/16"

(NS)



P FINGER JOINTED & PRIMED	C CLEAR PINE	FP FJ POPLAR DOUBLE PRIMED	W WINDSORONE TRIPLE COAT PRIME	F FLEXIBLE	<input checked="" type="checkbox"/> STOCK
M MEDIUM DENSITY FIBERBOARD	CP CLEAR POPLAR	SP SOLID POPLAR (NO FJ) DOUBLE PRIMED	M METRIE 3 DAY LEAD TIME	V CURVED, PG. 58	(NS) NON-STOCK AVAILABLE FOR QUICK DELIVERY

CASING

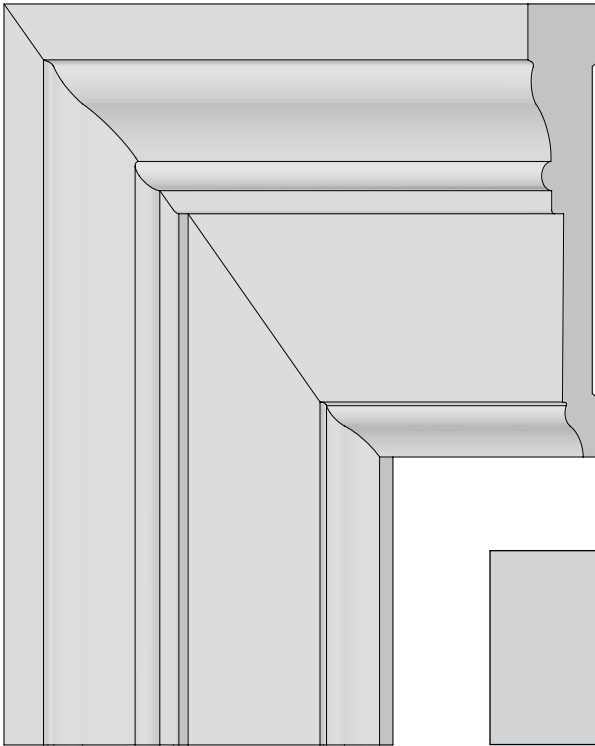

N-502
1" x 4-23/32"

(NS)

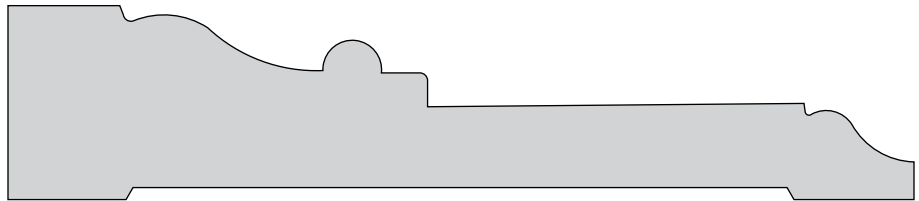

P FINGER JOINTED & PRIMED
M MEDIUM DENSITY FIBERBOARD

C CLEAR PINE
CP CLEAR POPLAR

FP FJ POPLAR DOUBLE PRIMED
SP SOLID POPLAR (NO FJ) DOUBLE PRIMED

W WINDSORONE TRIPLE COAT PRIME
M METRIE 3 DAY LEAD TIME

F FLEXIBLE
V CURVED, PG. 58

✓ STOCK
(NS) NON-STOCK AVAILABLE FOR QUICK DELIVERY

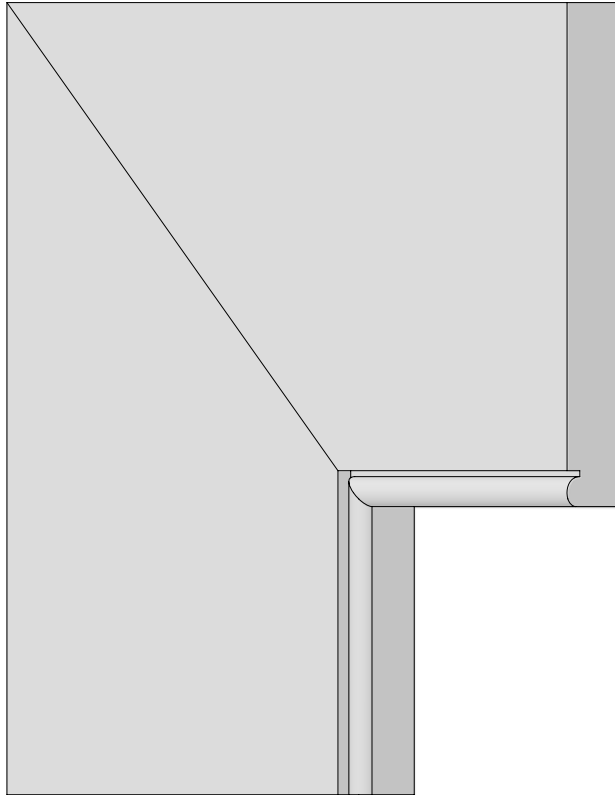

WPCS009
 Beaded
 3/4" x 5-1/4"



P FINGER JOINTED & PRIMED	C CLEAR PINE	FP FJ POPLAR DOUBLE PRIMED	W WINDSORONE TRIPLE COAT PRIME	F FLEXIBLE	<input checked="" type="checkbox"/> STOCK
M MEDIUM DENSITY FIBERBOARD	CP CLEAR POPLAR	SP SOLID POPLAR (NO FJ) DOUBLE PRIMED	M METRIE 3 DAY LEAD TIME	V CURVED, PG. 58	<input type="checkbox"/> NON-STOCK AVAILABLE FOR QUICK DELIVERY

CASING

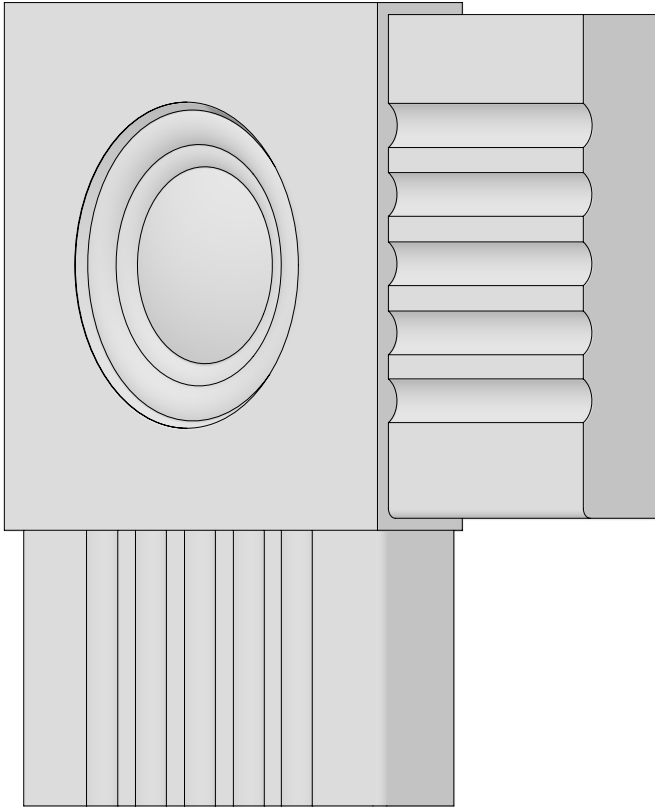

514FPIL
1-1/16" x 5-1/4"
Cut to Length 83-1/4"
(shown with rosette)

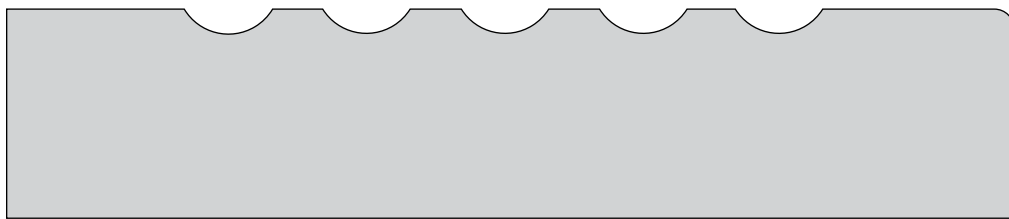

P FINGER JOINTED & PRIMED
M MEDIUM DENSITY FIBERBOARD

C CLEAR PINE
CP CLEAR POPLAR

FP FJ POPLAR DOUBLE PRIMED
SP SOLID POPLAR (NO FJ) DOUBLE PRIMED

W WINDSORONE TRIPLE COAT PRIME
M METRIE 3 DAY LEAD TIME

F FLEXIBLE
V CURVED, PG. 58

✓ STOCK
NS NON-STOCK AVAILABLE FOR QUICK DELIVERY

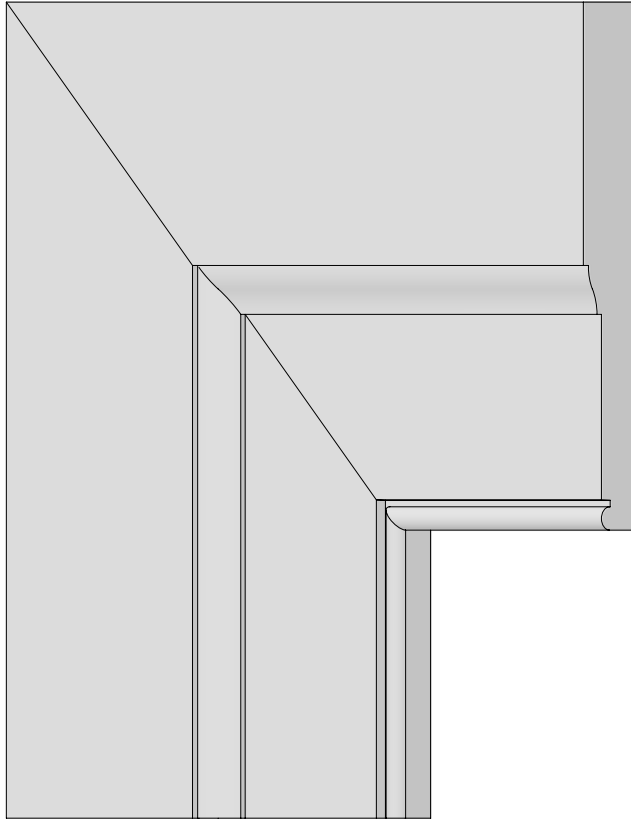

WOC001
 Classical Colonial
 3/4" x 5-1/2"

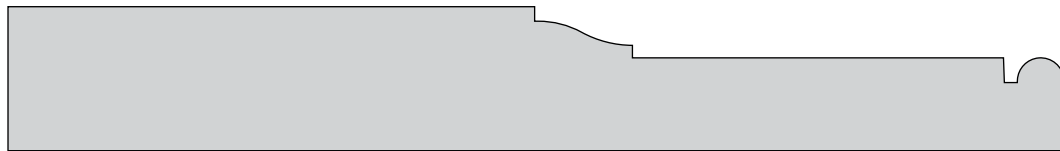

P FINGER JOINTED & PRIMED	C CLEAR PINE	FP FJ POPLAR DOUBLE PRIMED	WI WINDSORONE TRIPLE COAT PRIME	F FLEXIBLE	<input checked="" type="checkbox"/> STOCK
M MEDIUM DENSITY FIBERBOARD	CP CLEAR POPLAR	SP SOLID POPLAR (NO FJ) DOUBLE PRIMED	M METRIE 3 DAY LEAD TIME	V CURVED, PG. 58	<input type="checkbox"/> NON-STOCK AVAILABLE FOR QUICK DELIVERY

9" SAMPLES AVAILABLE UPON REQUEST. ALL MOULDINGS AVAILABLE IN ANY HARDWOOD OR SOFTWOOD SPECIES WITH SHORT LEAD TIME. AVAILABLE UNFINISHED, DOUBLE PRIMED, CLEAR FINISHED, STAINED OR PAINTED. WE HAVE KNIVES FOR OVER 5,000 PATTERNS AND WE ADD NEW CUSTOM PATTERNS EVERY DAY!

CURVED CASING

Curved Casing

CUSTOM CURVED CASINGS FOR HALF ROUNDS

Our Architectural Products Division manufactures a wide variety of custom sized half round casings available in five patterns. The most economical product to use for paint grade casing is MDF (medium density fiberboard). Other readily available species include pine, poplar, red oak, & sapele.

ALLOW 3-5 DAY LEAD TIME

- Call for quote on any diameter less than 20"
- Smallest radius must be no less than 10"
- Wood casings available in any profile up to 4-1/2" width
Call for quote and lead time.
- Profiles wider than 4-1/2" are available in 2 pieces across the width and can be joined in the factory or in the field.

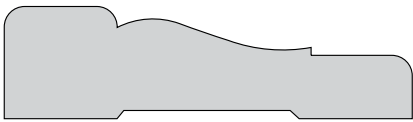
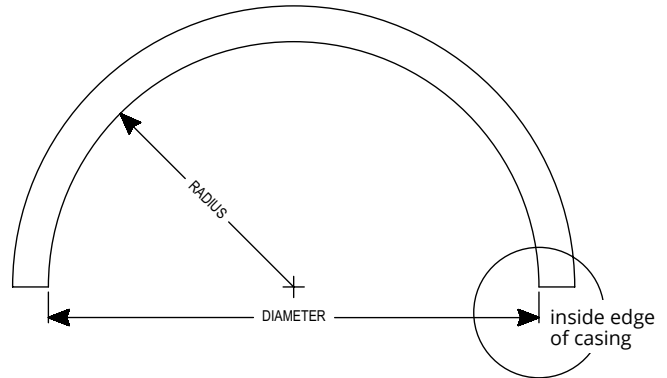

WM351 (8710) Colonial (Page 29)
1 1/16" x 2-1/2"



WM444 (8754) Colonial (Page 35)
1 1/16" x 3-1/2"



S4S Flat Stock
3/4" x 3-1/2"

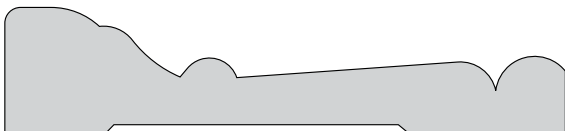

WMSTAFFP Stafford (Page 35)
3/4" x 3-7/16"

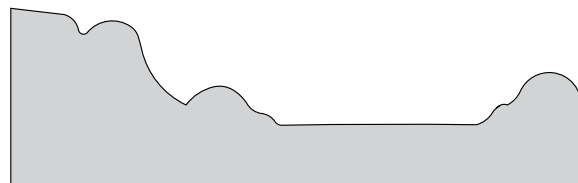

WMWINDSOR Windsor (Page 36)
1" x 3-1/2"

CUSTOM PROFILES AVAILABLE

P FINGER JOINTED & PRIMED
M MEDIUM DENSITY FIBERBOARD

C CLEAR PINE
CP CLEAR POPLAR

FP FJ POPLAR DOUBLE PRIMED
SP SOLID POPLAR (NO FJ) DOUBLE PRIMED

W WINDSORONE TRIPLE COAT PRIME
M METRIE 3 DAY LEAD TIME

F FLEXIBLE
V CURVED, PG. 58

✓ STOCK
NS NON-STOCK AVAILABLE FOR QUICK DELIVERY

Chairrail

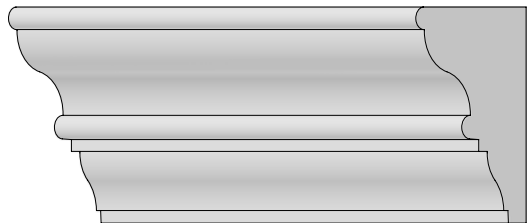

WOCH001
 Classical Colonial
 1-5/8" x 2-1/4"

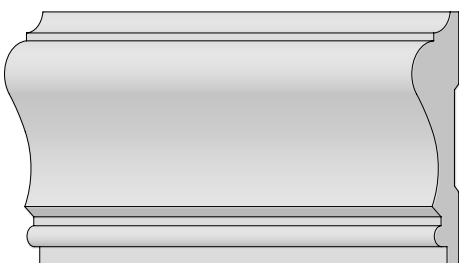
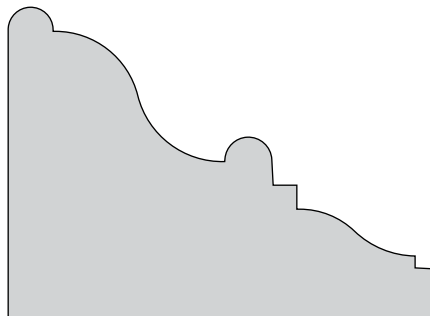

WM390/N-762
 Governor Francis
 11/16" x 2-5/8"

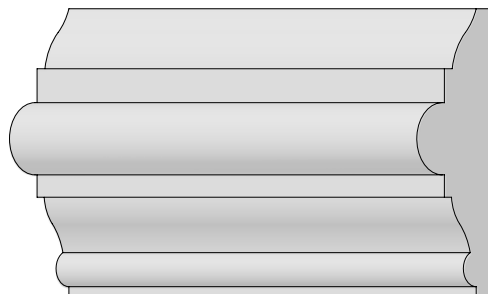
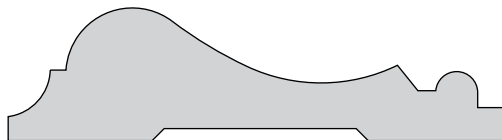

WM300
 Williamsburg
 1-1/16" x 3"

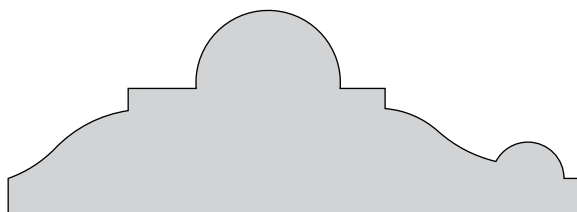

N-591
 1-1/16" x 3"

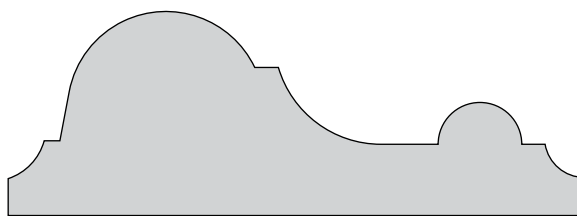

P FINGER JOINTED & PRIMED	C CLEAR PINE	FP FJ POPLAR DOUBLE PRIMED	W WINDSORONE TRIPLE COAT PRIME	F FLEXIBLE	✓ STOCK
M MEDIUM DENSITY FIBERBOARD	CP CLEAR POPLAR	SP SOLID POPLAR (NO FJ) DOUBLE PRIMED	M METRIE 3 DAY LEAD TIME	V CURVED, PG. 58	NS NON-STOCK AVAILABLE FOR QUICK DELIVERY

CROWN

Crown

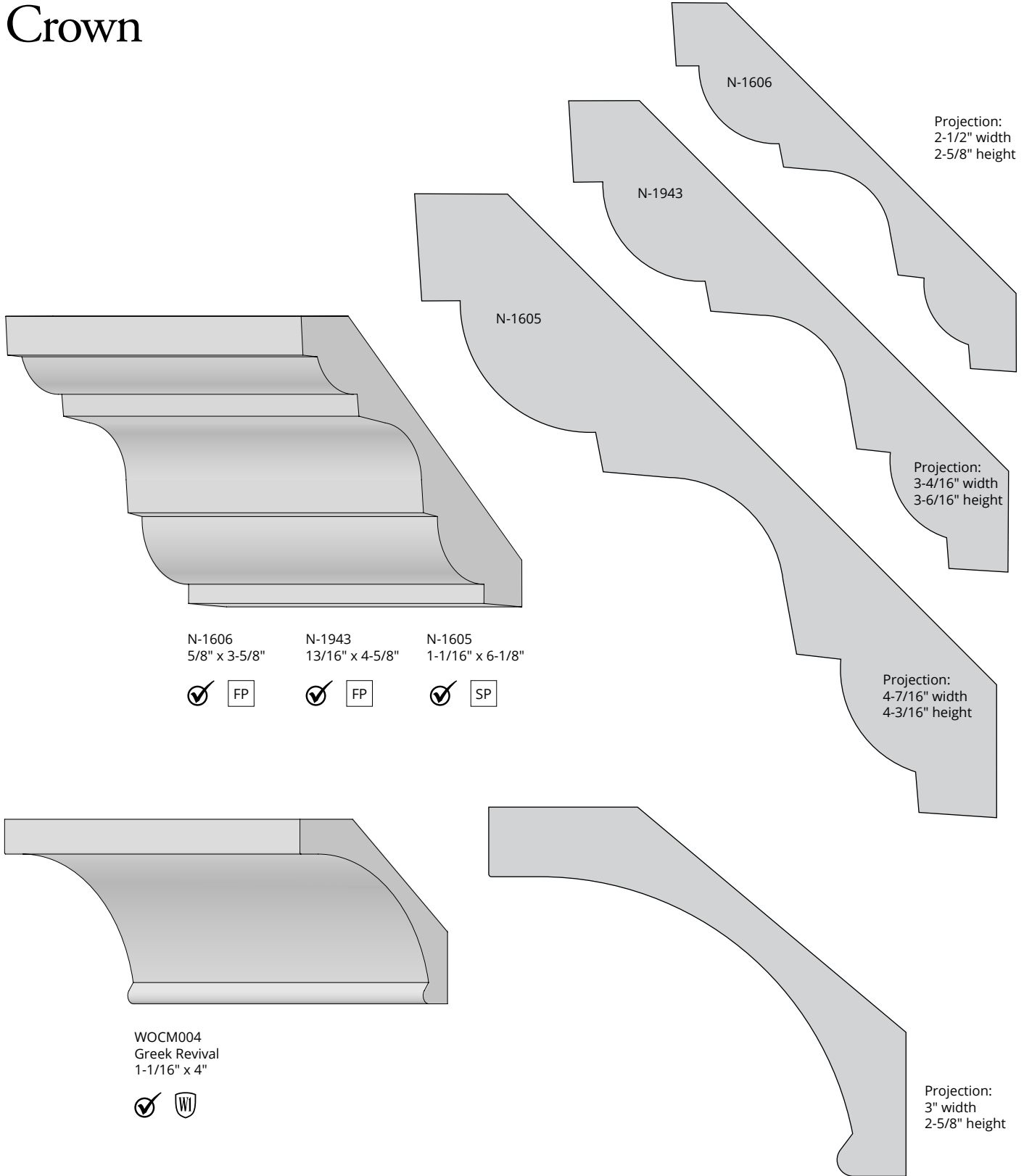

N-1606
5/8" x 3-5/8"



N-1943
13/16" x 4-5/8"



N-1605
1-1/16" x 6-1/8"



WOCM004
Greek Revival
1-1/16" x 4"



Projection:
2-1/2" width
2-5/8" height

Projection:
3-4/16" width
3-6/16" height

Projection:
4-7/16" width
4-3/16" height

Projection:
3" width
2-5/8" height

P FINGER JOINTED & PRIMED
M MEDIUM DENSITY FIBERBOARD

C CLEAR PINE
CP CLEAR POPLAR

FP FJ POPLAR DOUBLE PRIMED
SP SOLID POPLAR (NO FJ) DOUBLE PRIMED

W WINDSORONE TRIPLE COAT PRIME
M METRIE 3 DAY LEAD TIME

F FLEXIBLE
V CURVED, PG. 58

✓ STOCK
NS NON-STOCK AVAILABLE FOR QUICK DELIVERY

9" SAMPLES AVAILABLE UPON REQUEST. ALL MOULDINGS AVAILABLE IN ANY HARDWOOD OR SOFTWOOD SPECIES WITH SHORT LEAD TIME. AVAILABLE UNFINISHED, DOUBLE PRIMED, CLEAR FINISHED, STAINED OR PAINTED. WE HAVE KNIVES FOR OVER 5,000 PATTERNS AND WE ADD NEW CUSTOM PATTERNS EVERY DAY!

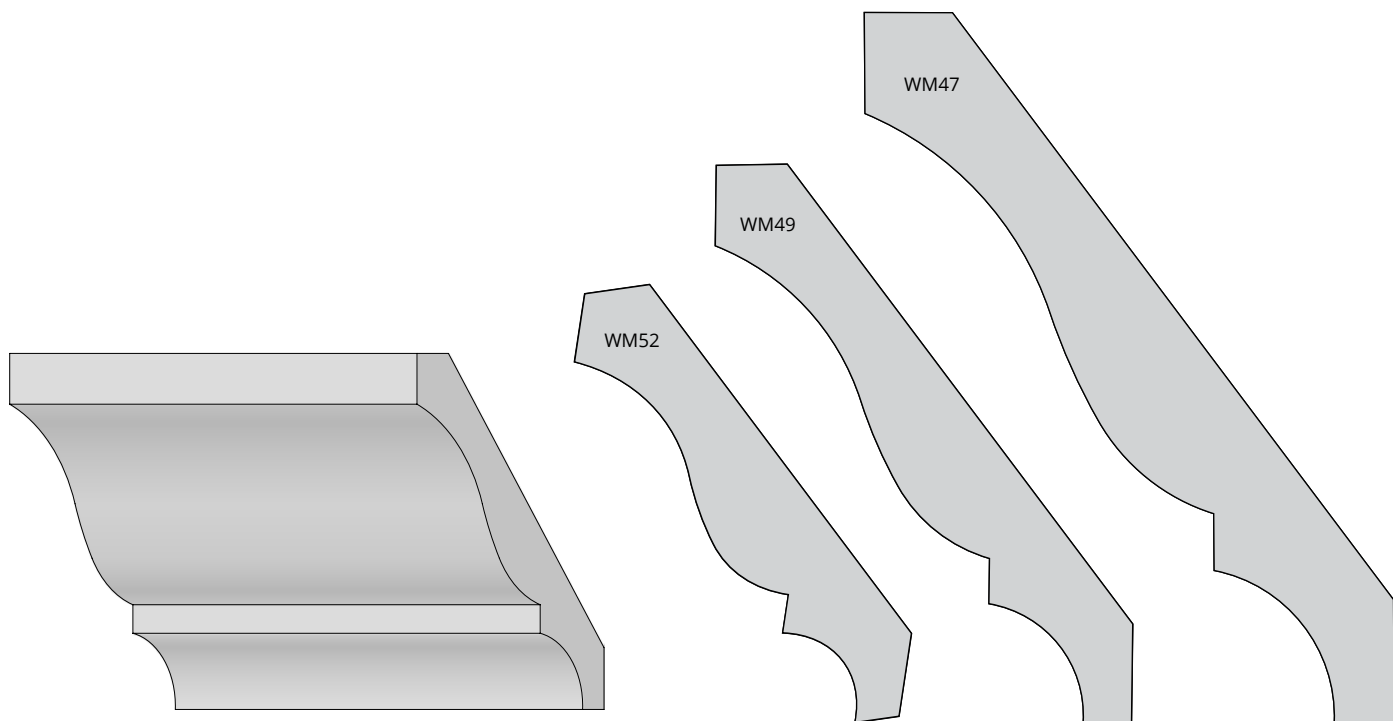

WM52 (8010)
9/16" x 2-3/4"



WM49 (8009)
9/16" x 3-5/8"



WM47 (8013)
1 1/16" x 4-5/8"



Projection:
1-5/8" width
2-1/4" height

Projection:
2" width
3" height

Projection:
2-3/4" width
3-11/16" height

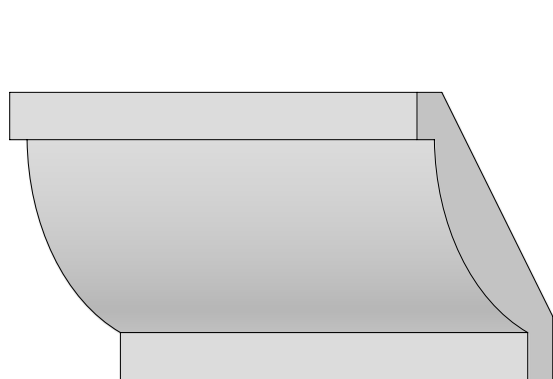

WOCM001
Classical Colonial
3/4" x 3-9/16"



Projection:
2" width
3" height

<input type="checkbox"/> P FINGER JOINTED & PRIMED	<input type="checkbox"/> C CLEAR PINE	<input type="checkbox"/> FP FJ POPLAR DOUBLE PRIMED	<input type="checkbox"/> W WINDSORONE TRIPLE COAT PRIME	<input type="checkbox"/> F FLEXIBLE	<input checked="" type="checkbox"/> STOCK
<input type="checkbox"/> M MEDIUM DENSITY FIBERBOARD	<input type="checkbox"/> CP CLEAR POPLAR	<input type="checkbox"/> SP SOLID POPLAR (NO FJ) DOUBLE PRIMED	<input type="checkbox"/> M METRIE 3 DAY LEAD TIME	<input type="checkbox"/> V CURVED, PG. 58	<input type="checkbox"/> NS NON-STOCK AVAILABLE FOR QUICK DELIVERY

CROWN

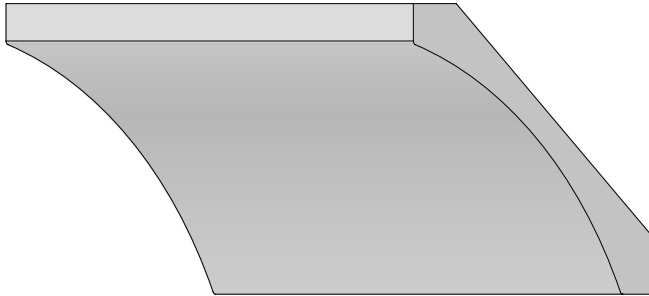

WOCM006
Colonial Revival
3/4" x 4-9/16"

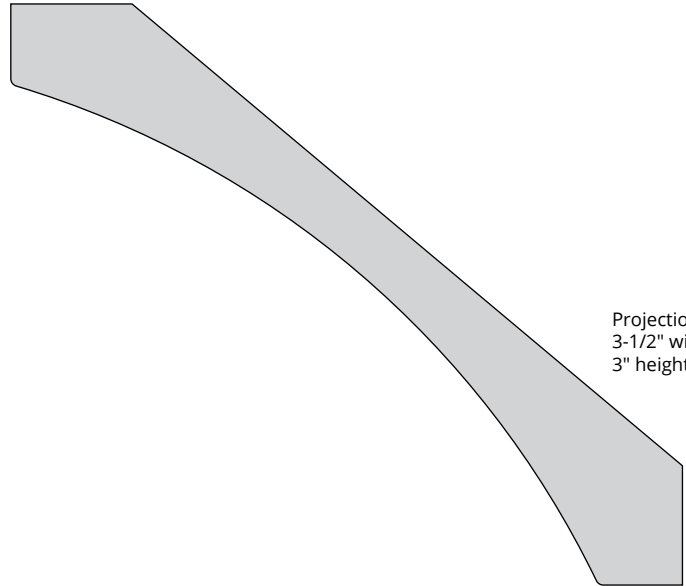

Projection:
3-1/2" width
3" height

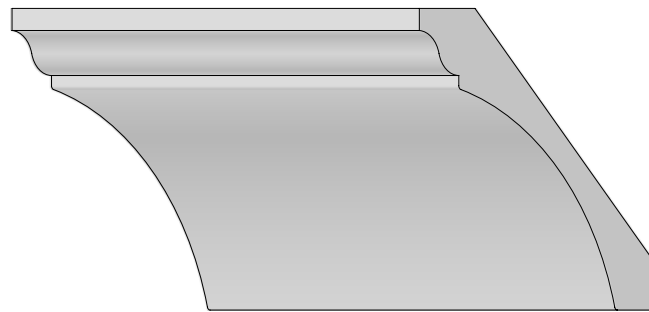

WOCM005
Classical Craftsmen
3/4" x 4-9/16"

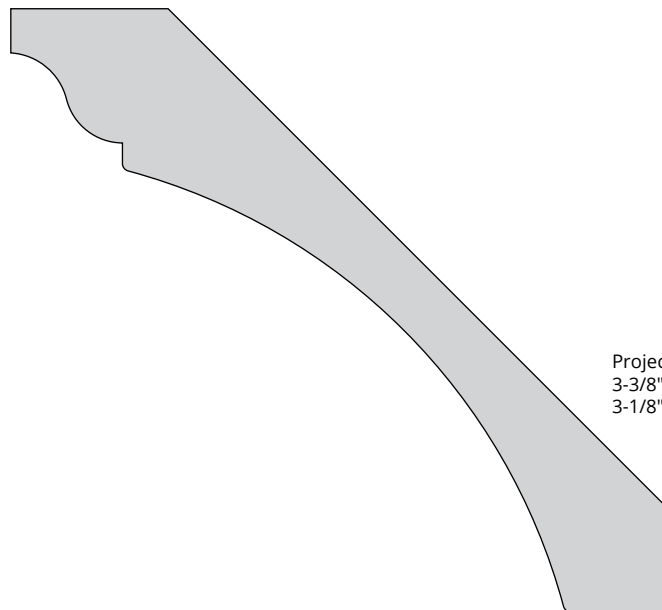

Projection:
3-3/8" width
3-1/8" height

P FINGER JOINTED & PRIMED
M MEDIUM DENSITY FIBERBOARD

C CLEAR PINE
CP CLEAR POPLAR

FP FJ POPLAR DOUBLE PRIMED
SP SOLID POPLAR (NO FJ) DOUBLE PRIMED

W WINDSORONE TRIPLE COAT PRIME
M METRIE 3 DAY LEAD TIME

F FLEXIBLE
V CURVED, PG. 58

✓ STOCK
NS NON-STOCK AVAILABLE FOR QUICK DELIVERY

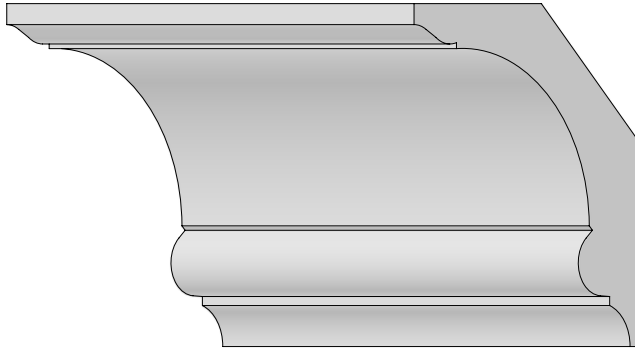

N-716
 1-5/8" x 4-7/8"

(NS)

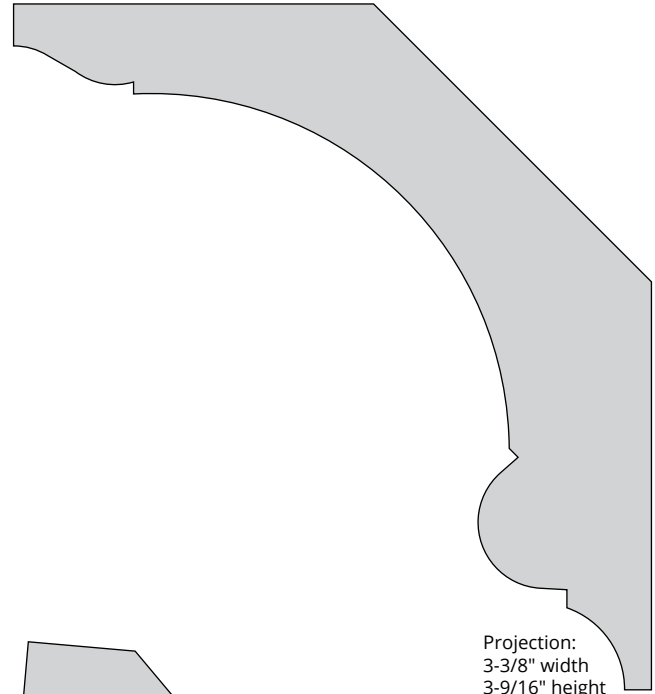

Projection:
 3-3/8" width
 3-9/16" height

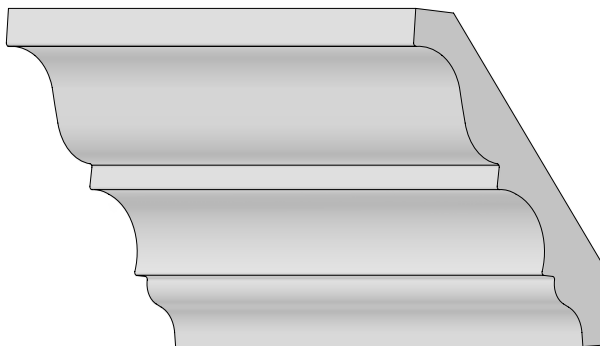

N-388
 3/4" x 4-7/16"

(NS)

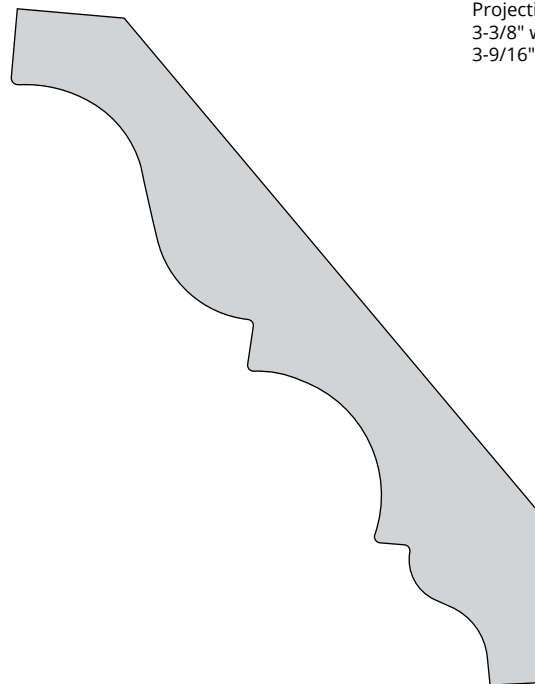

Projection:
 2-3/4" width
 3-1/2" height

P FINGER JOINTED & PRIMED	C CLEAR PINE	FP FJ POPLAR DOUBLE PRIMED	W WINDSORONE TRIPLE COAT PRIME	F FLEXIBLE	<input checked="" type="checkbox"/> STOCK
M MEDIUM DENSITY FIBERBOARD	CP CLEAR POPLAR	SP SOLID POPLAR (NO FJ) DOUBLE PRIMED	M METRIE 3 DAY LEAD TIME	V CURVED, PG. 58	(NS) NON-STOCK AVAILABLE FOR QUICK DELIVERY

CROWN

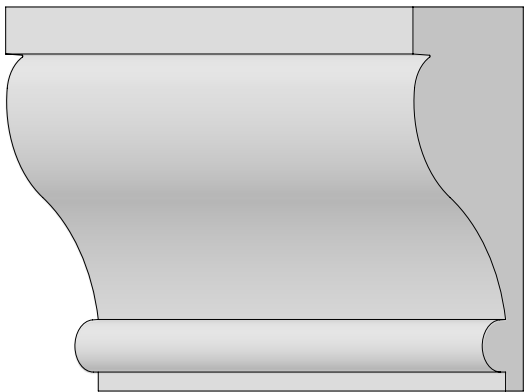

WOCM003
Classical Colonial
1-5/8" x 4"

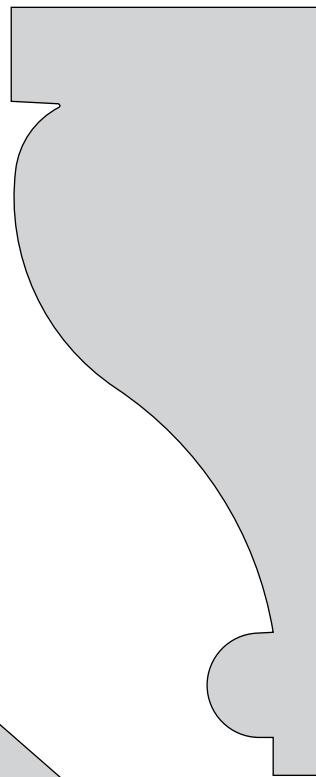

Projection:
1-5/8" width
4" height

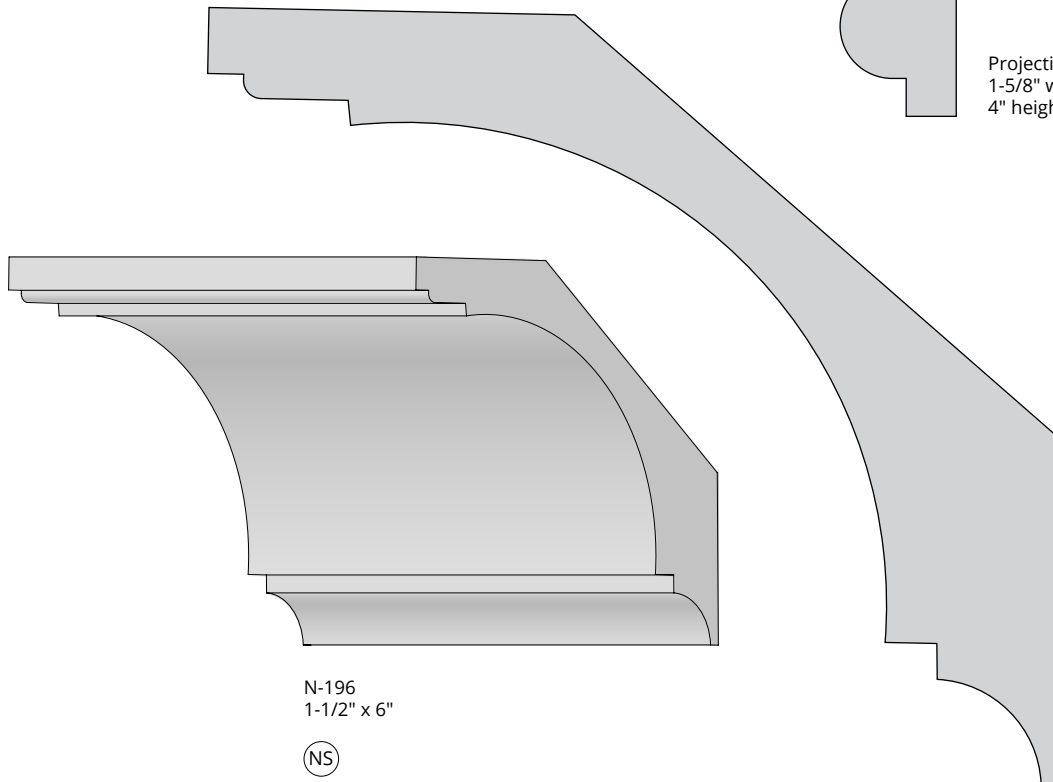

N-196
1-1/2" x 6"



Projection:
4-7/16" width
4-1/16" height

P FINGER JOINTED & PRIMED
M MEDIUM DENSITY FIBERBOARD

C CLEAR PINE
CP CLEAR POPLAR

FP FJ POPLAR DOUBLE PRIMED
SP SOLID POPLAR (NO FJ) DOUBLE PRIMED

W WINDSORONE TRIPLE COAT PRIME
M METRIE 3 DAY LEAD TIME

F FLEXIBLE
V CURVED, PG. 58

✓ STOCK
NS NON-STOCK AVAILABLE FOR QUICK DELIVERY



N1501P
 1-5/16" x 1-13/16"

✓ SP

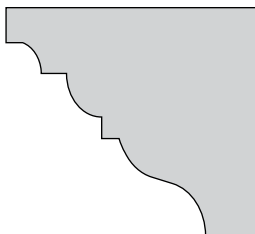

N-454
 7/8" x 3-3/16"

(NS)



Projection:
 2-3/8" width
 2-3/16" height

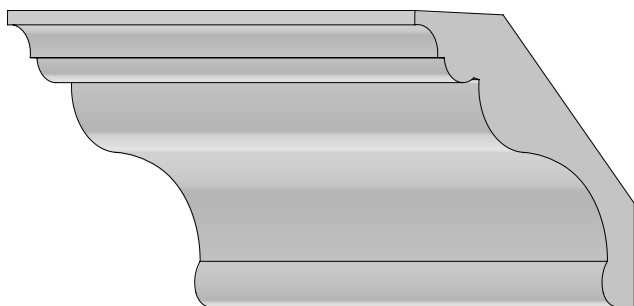

N-2371
 1" x 4-15/32"

(NS)

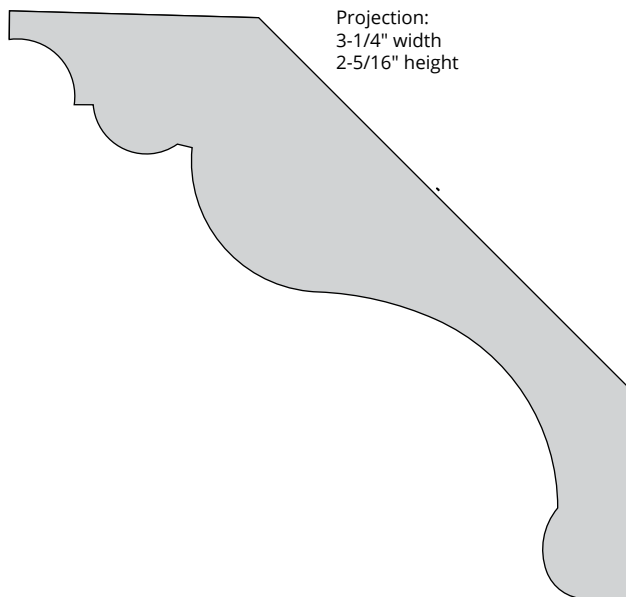

Projection:
 3-1/4" width
 2-5/16" height

P FINGER JOINTED & PRIMED	C CLEAR PINE	FP FJ POPLAR DOUBLE PRIMED	W WINDSORONE TRIPLE COAT PRIME	F FLEXIBLE	✓ STOCK
M MEDIUM DENSITY FIBERBOARD	CP CLEAR POPLAR	SP SOLID POPLAR (NO FJ) DOUBLE PRIMED	M METRIE 3 DAY LEAD TIME	V CURVED, PG. 58	(NS) NON-STOCK AVAILABLE FOR QUICK DELIVERY

CROWN

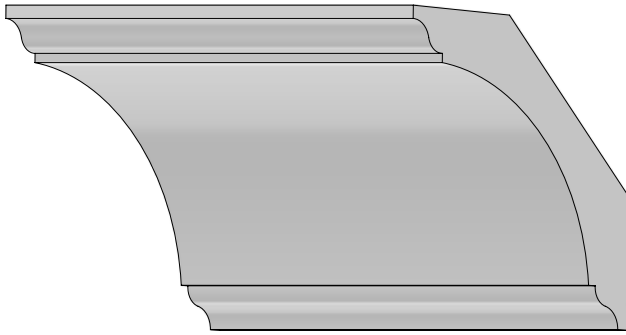

N-2363
1-1/16" x 4-5/8"

(NS)

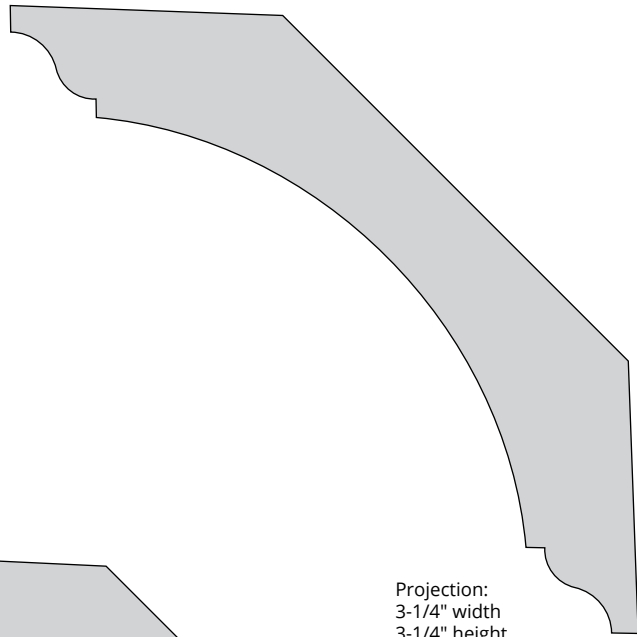

Projection:
3-1/4" width
3-1/4" height

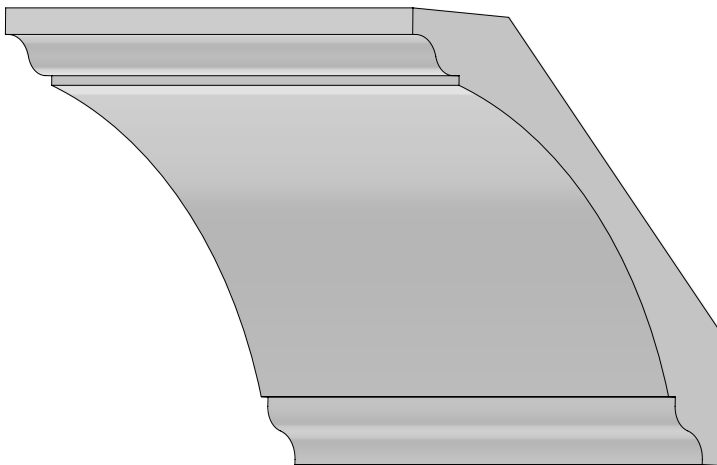

N-2375
1-5/32" x 6-9/16"

(NS)

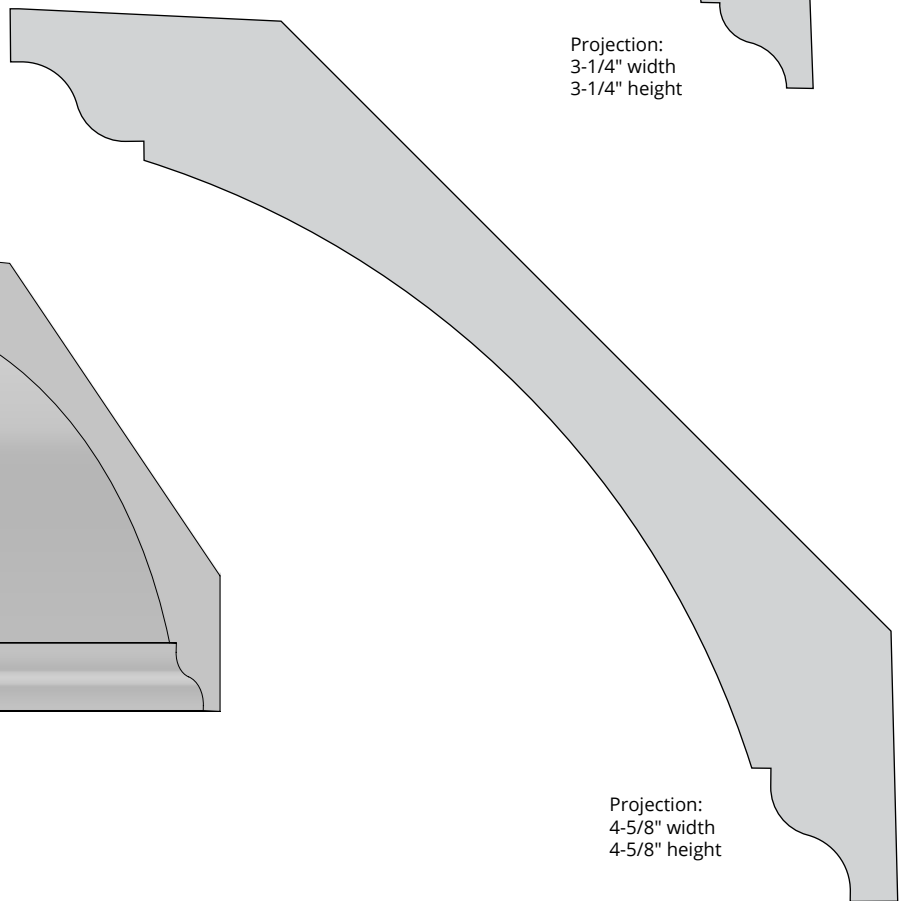

Projection:
4-5/8" width
4-5/8" height

P FINGER JOINTED & PRIMED
M MEDIUM DENSITY FIBERBOARD

C CLEAR PINE
CP CLEAR POPLAR

FP FJ POPLAR DOUBLE PRIMED
SP SOLID POPLAR (NO FJ) DOUBLE PRIMED

W WINDSORONE TRIPLE COAT PRIME
M METRIE 3 DAY LEAD TIME

F FLEXIBLE
V CURVED, PG. 58

✓ STOCK
(NS) NON-STOCK AVAILABLE FOR QUICK DELIVERY

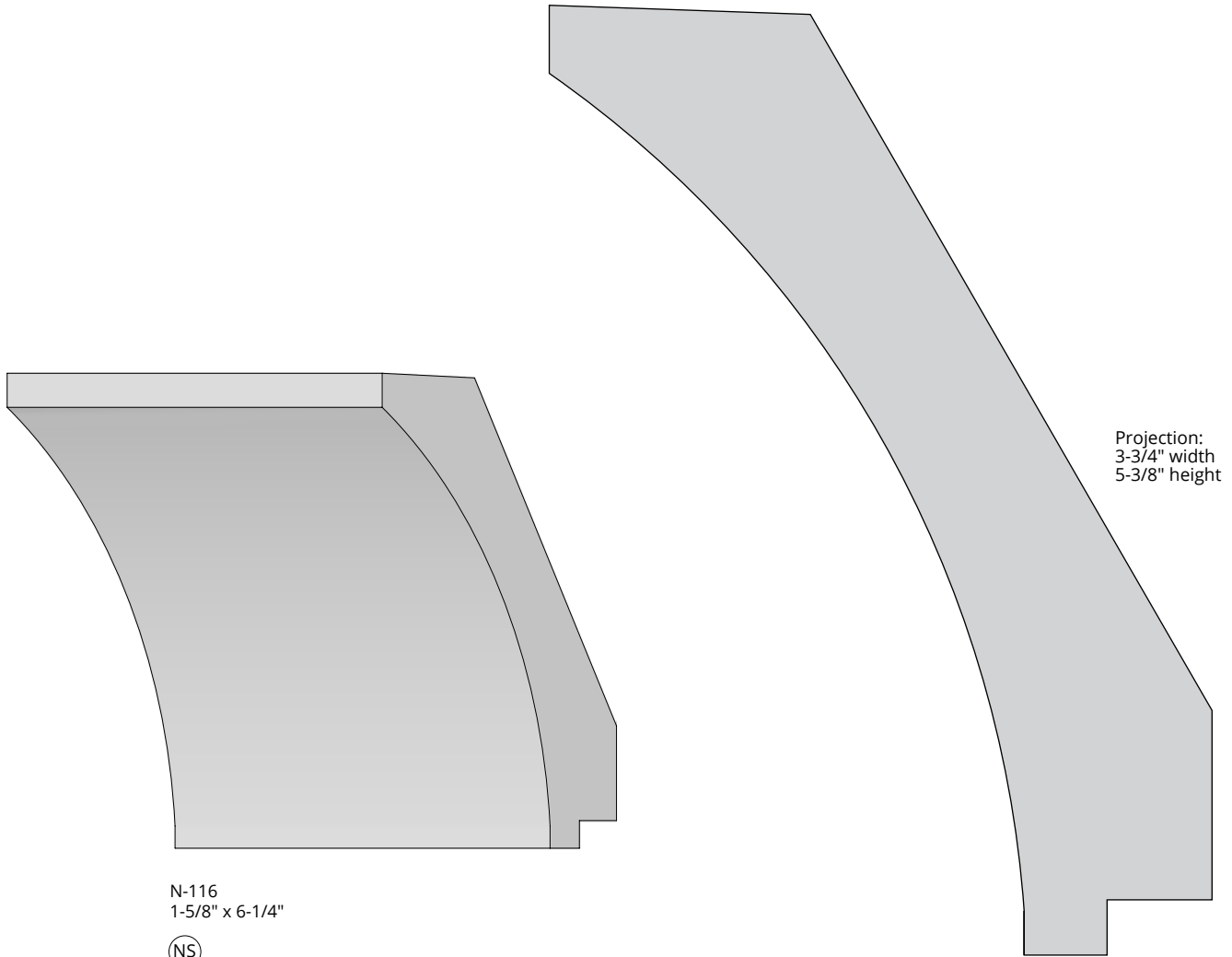

N-116
 1-5/8" x 6-1/4"

(NS)

Projection:
 3-3/4" width
 5-3/8" height

P FINGER JOINTED & PRIMED	C CLEAR PINE	FP FJ POPLAR DOUBLE PRIMED	W WINDSORONE TRIPLE COAT PRIME	F FLEXIBLE	<input checked="" type="checkbox"/> STOCK
M MEDIUM DENSITY FIBERBOARD	CP CLEAR POPLAR	SP SOLID POPLAR (NO FJ) DOUBLE PRIMED	M METRIE 3 DAY LEAD TIME	V CURVED, PG. 58	(NS) NON-STOCK AVAILABLE FOR QUICK DELIVERY

CROWN

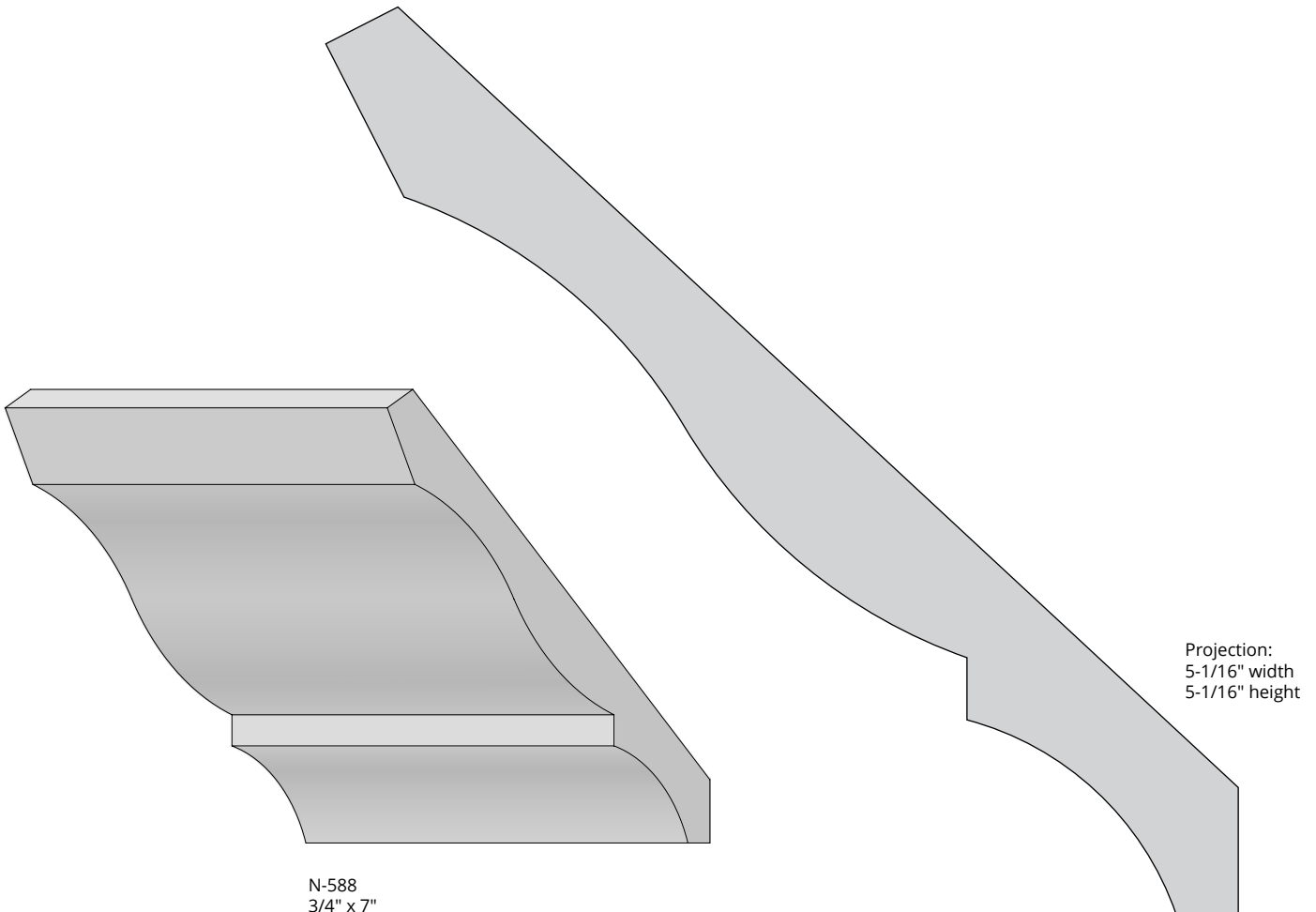

N-588
3/4" x 7"

(NS)

P FINGER JOINTED & PRIMED
M MEDIUM DENSITY FIBERBOARD

C CLEAR PINE
CP CLEAR POPLAR

FP FJ POPLAR DOUBLE PRIMED
SP SOLID POPLAR (NO FJ) DOUBLE PRIMED

W WINDSORONE TRIPLE COAT PRIME
M METRIE 3 DAY LEAD TIME

F FLEXIBLE
V CURVED, PG. 58

✓ STOCK
(NS) NON-STOCK AVAILABLE FOR QUICK DELIVERY

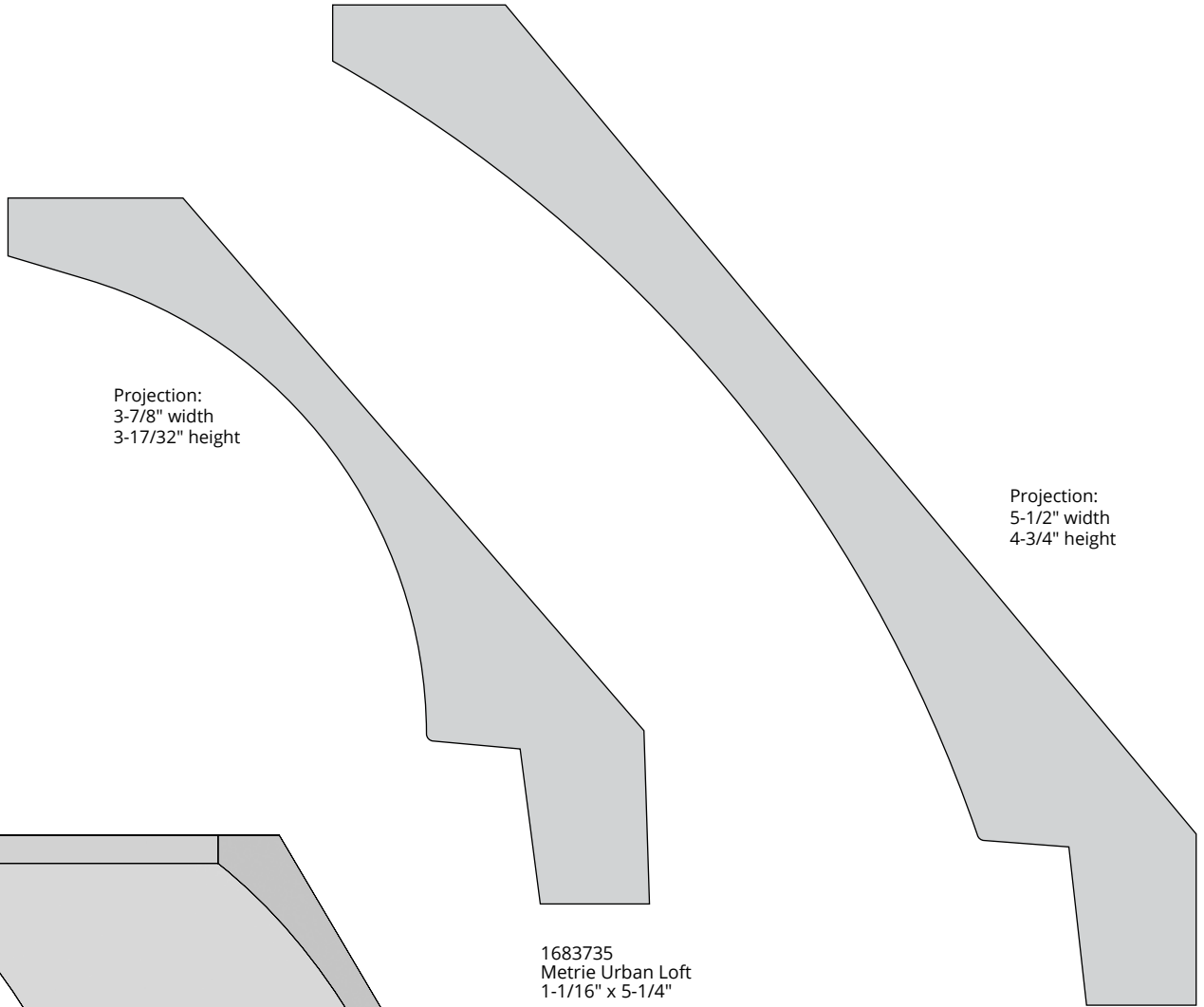

Projection:
 3-7/8" width
 3-17/32" height

Projection:
 5-1/2" width
 4-3/4" height

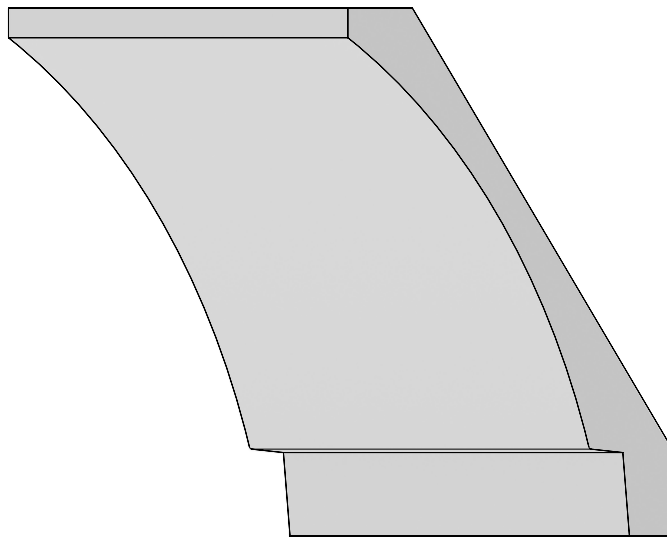

1683735
 Metrie Urban Loft
 1-1/16" x 5-1/4"

PRIMED
 FJ POPLAR

1683736
 Metrie Urban Loft
 1-1/16" x 7-1/4"

PRIMED
 FJ POPLAR

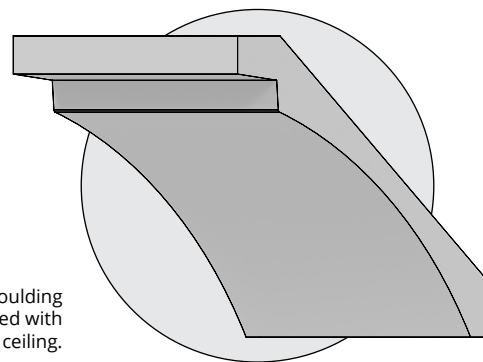

This crown moulding
 can be oriented with
 the step at the ceiling.

FINGER JOINTED & PRIMED	CLEAR PINE	FJ POPLAR DOUBLE PRIMED	WINDSORONE TRIPLE COAT PRIME	FLEXIBLE	STOCK
MEDIUM DENSITY FIBERBOARD	CLEAR POPLAR	SOLID POPLAR (NO FJ) DOUBLE PRIMED	METRIE 3 DAY LEAD TIME	CURVED, PG. 58	NON-STOCK AVAILABLE FOR QUICK DELIVERY

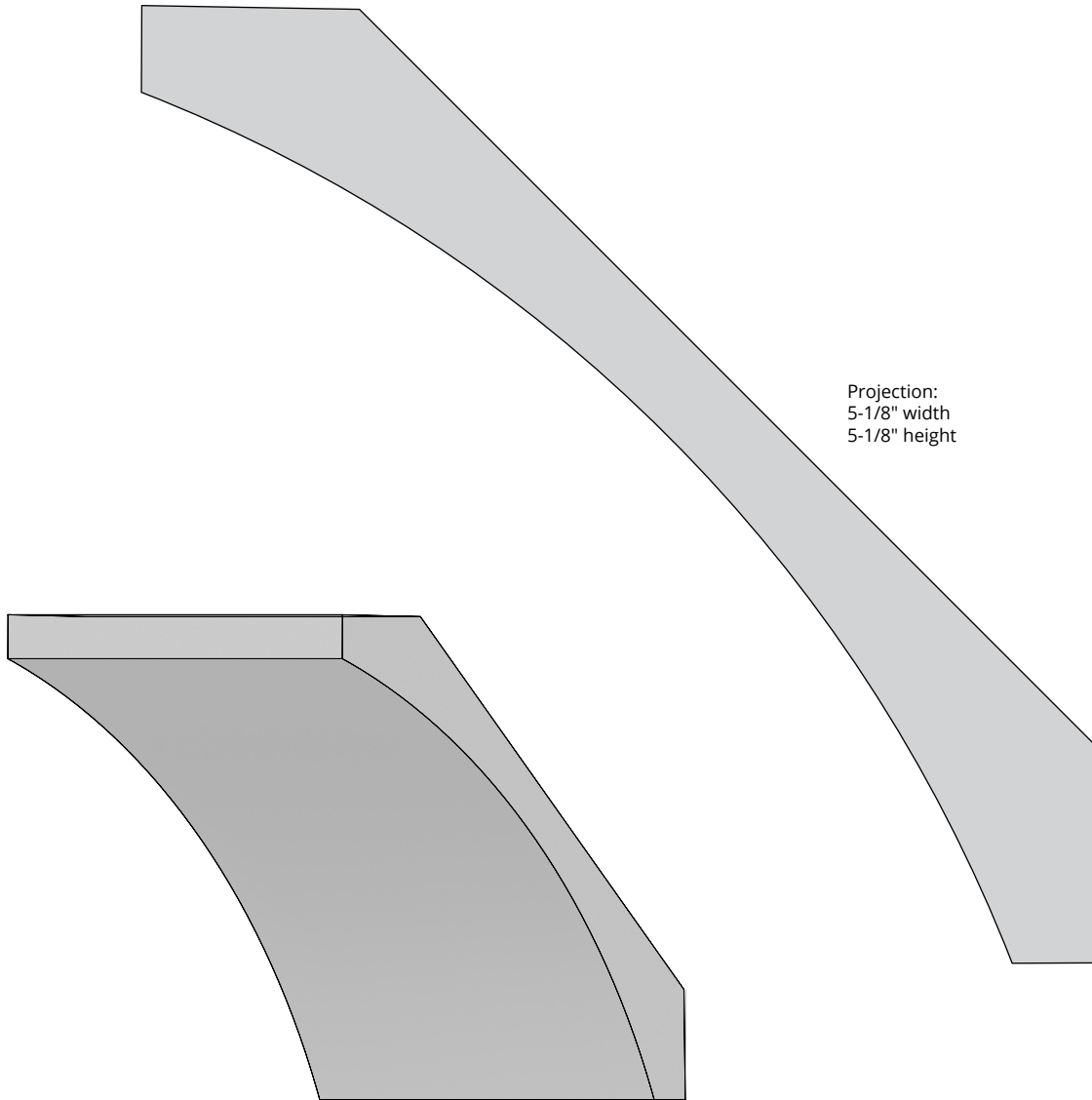

CROWN







Projection:
5-1/8" width
5-1/8" height



1683741
Metrie Urban Loft
1-1/8" x 7-1/4"



 PRIMED
FJ POPLAR

 FINGER JOINTED & PRIMED
 MEDIUM DENSITY FIBERBOARD

 CLEAR PINE
 CLEAR POPLAR

 FJ POPLAR DOUBLE PRIMED
 SOLID POPLAR (NO FJ) DOUBLE PRIMED

 WINDSORONE TRIPLE COAT PRIME
 METRIE 3 DAY LEAD TIME

 FLEXIBLE
 CURVED, PG. 58

 STOCK
 NON-STOCK AVAILABLE FOR QUICK DELIVERY

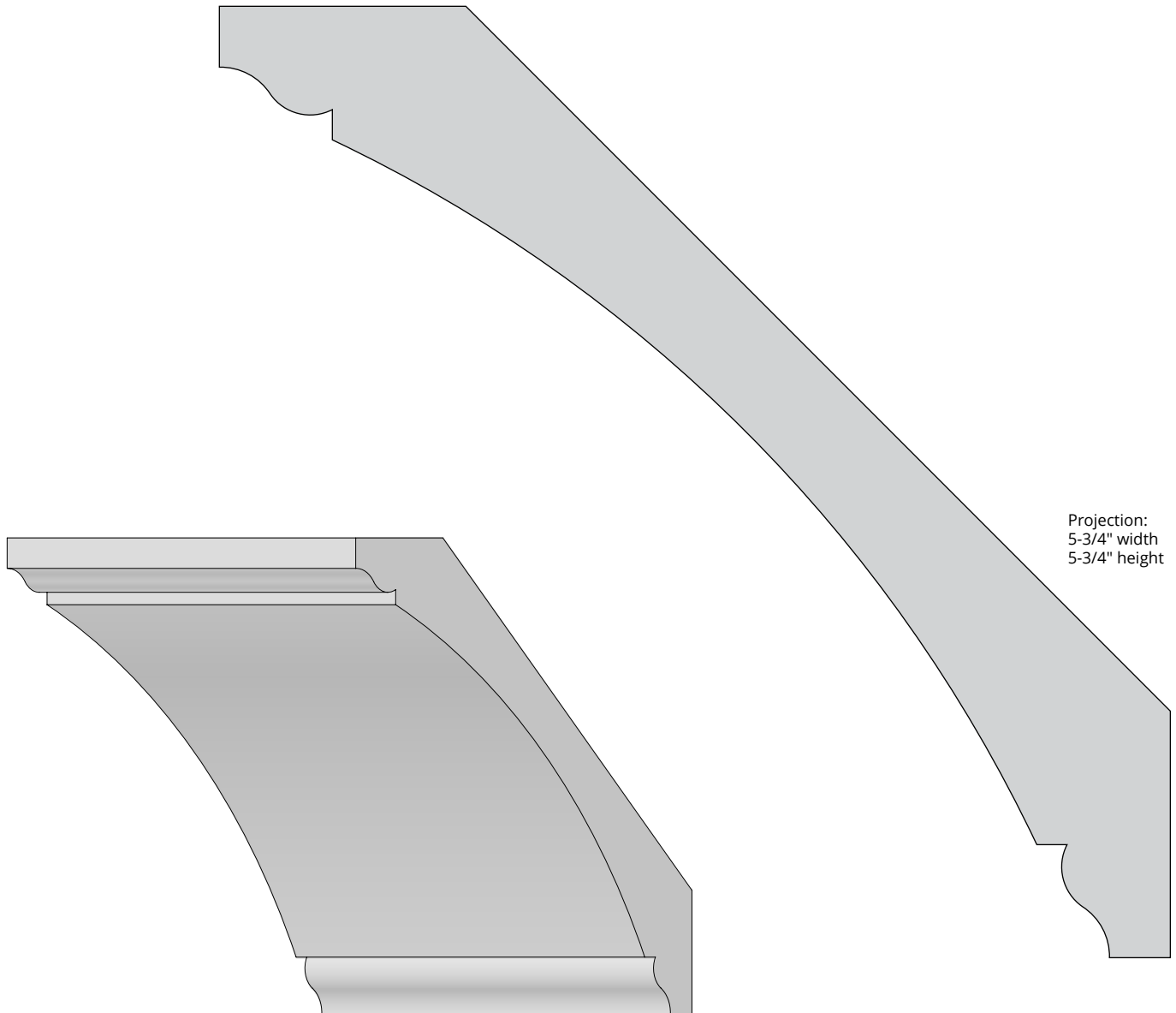

Projection:
 5-3/4" width
 5-3/4" height

N-214
 1-5/16" x 8-3/16"

(NS)

- | | | | | | |
|------------------------------------|------------------------|--|---------------------------------------|-------------------------|--|
| P FINGER JOINTED & PRIMED | C CLEAR PINE | FP FJ POPLAR DOUBLE PRIMED | W WINDSORONE TRIPLE COAT PRIME | F FLEXIBLE | <input checked="" type="checkbox"/> STOCK |
| M MEDIUM DENSITY FIBERBOARD | CP CLEAR POPLAR | SP SOLID POPLAR (NO FJ) DOUBLE PRIMED | M METRIE 3 DAY LEAD TIME | V CURVED, PG. 58 | (NS) NON-STOCK AVAILABLE FOR QUICK DELIVERY |

9" SAMPLES AVAILABLE UPON REQUEST. ALL MOULDINGS AVAILABLE IN ANY HARDWOOD OR SOFTWOOD SPECIES WITH SHORT LEAD TIME. AVAILABLE UNFINISHED, DOUBLE PRIMED, CLEAR FINISHED, STAINED OR PAINTED. WE HAVE KNIVES FOR OVER 5,000 PATTERNS AND WE ADD NEW CUSTOM PATTERNS EVERY DAY!

BUILT-UP CROWNS

Built-up Crowns

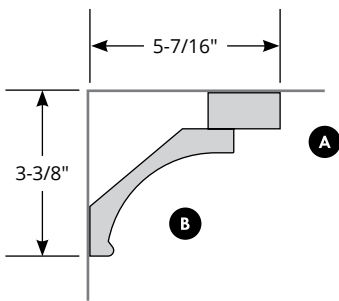
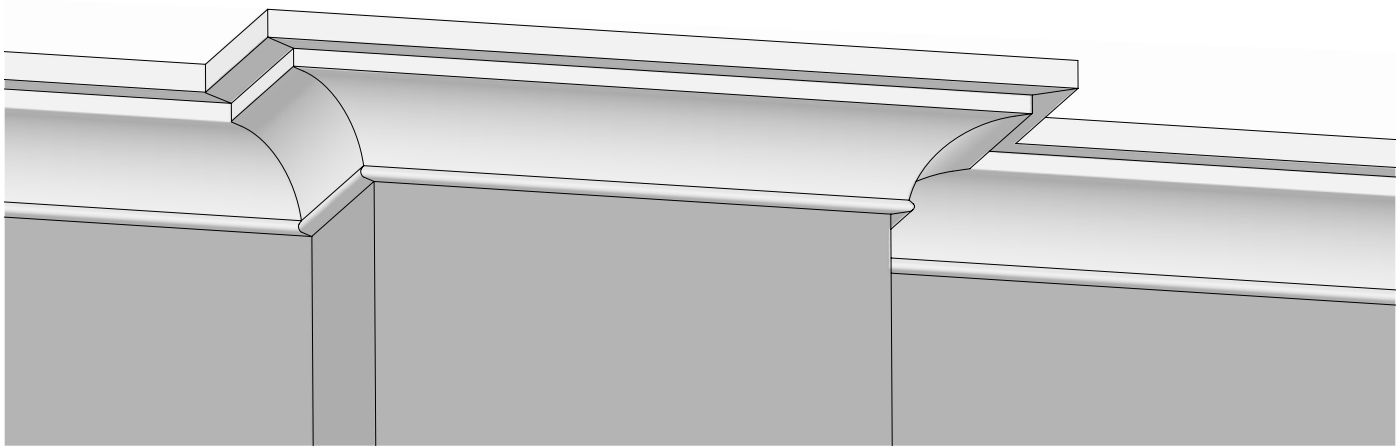

WINDSORONE GREEK REVIVAL

A S34112P
(1x2 S4SSE)
3/4" x 4-1/2"
✓ WI

B WOCM004
Greek Revival
1-1/16" x 4"
✓ WI

P FINGER JOINTED & PRIMED
M MEDIUM DENSITY FIBERBOARD

C CLEAR PINE
CP CLEAR POPLAR

FP FJ POPLAR DOUBLE PRIMED
SP SOLID POPLAR (NO FJ) DOUBLE PRIMED

WI WINDSORONE TRIPLE COAT PRIME
M METRIE 3 DAY LEAD TIME

F FLEXIBLE
V CURVED, PG. 58

✓ **STOCK**
NS NON-STOCK AVAILABLE FOR QUICK DELIVERY

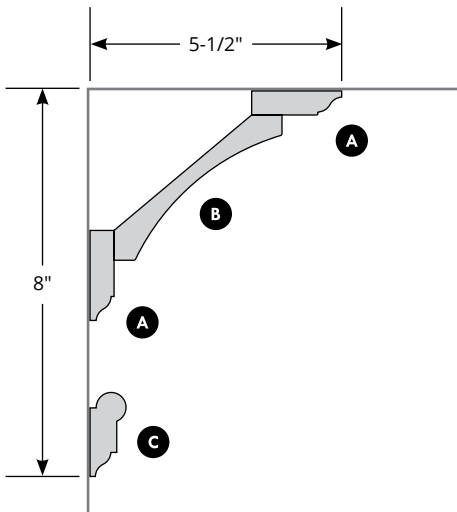
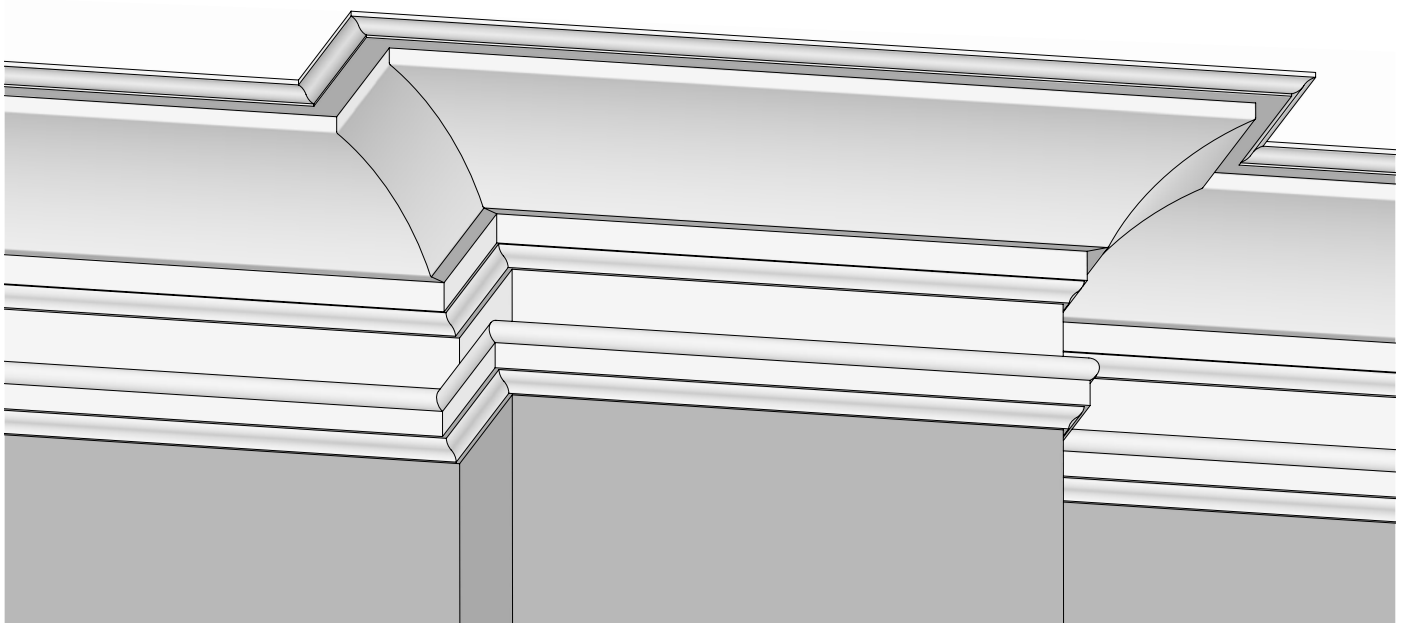

WINDSORONE COLONIAL REVIVAL

A WOST004
 Colonial Revival
 1-7/8" x 1/2"



B WOCM006
 Colonial Revival
 3/4" x 4-9/16"



C WOPM004
 Colonial Revival
 3/4" x 1-3/4"



P FINGER JOINTED & PRIMED

C CLEAR PINE

FP FJ POPLAR DOUBLE PRIMED

W WINDSORONE TRIPLE COAT PRIME

F FLEXIBLE

✓ STOCK

M MEDIUM DENSITY FIBERBOARD

CP CLEAR POPLAR

SP SOLID POPLAR (NO FJ) DOUBLE PRIMED

M METRIE 3 DAY LEAD TIME

V CURVED, PG. 58

NS NON-STOCK AVAILABLE FOR QUICK DELIVERY

BUILT-UP CROWNS

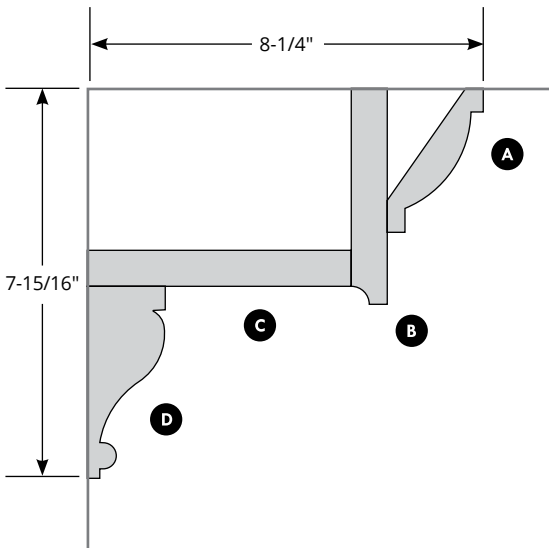
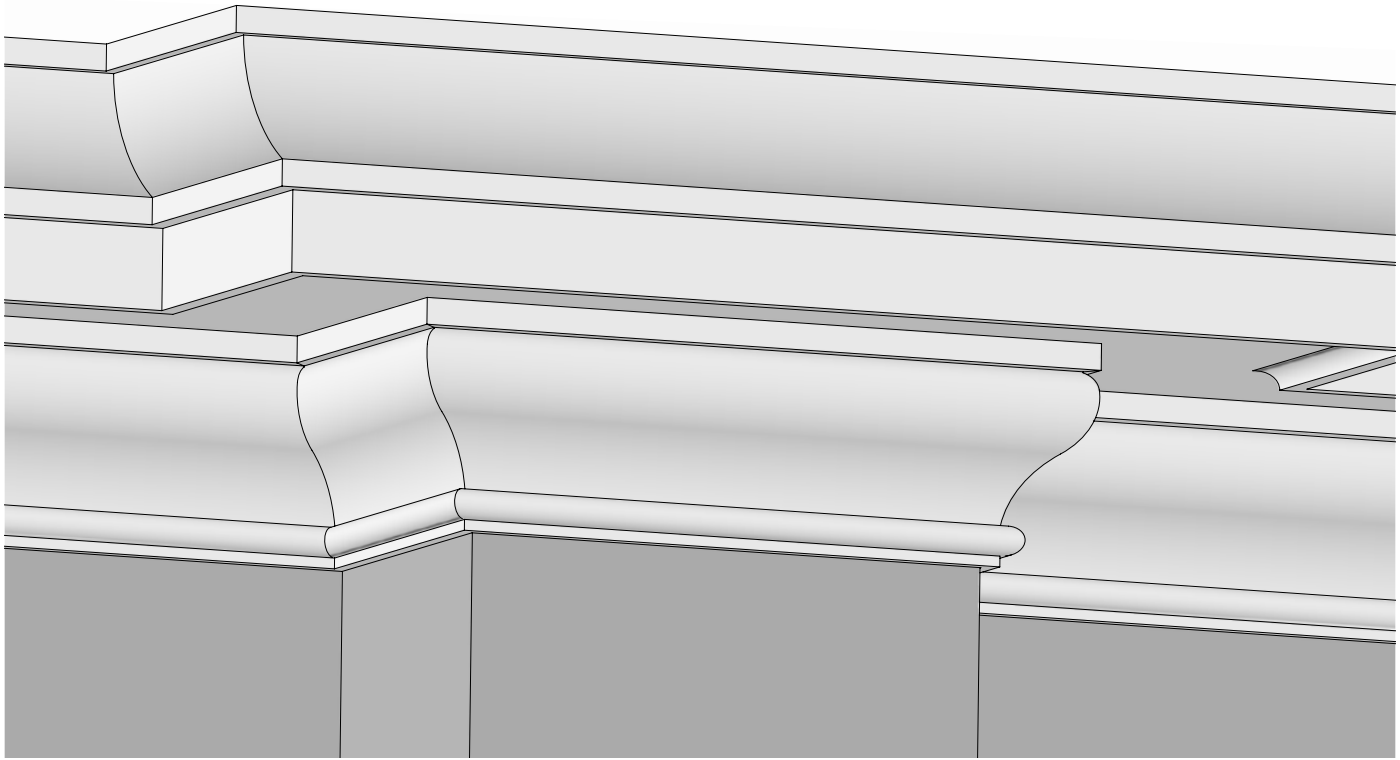

WINDSORONE CLASSICAL COLONIAL

- | | |
|---|---|
| <p>A WOCM001
Classical Colonial
3/4" x 3-9/16"</p> <p>✓ WI</p> | <p>B WOCM002
Classical Colonial
3/4" x 4-5/16"</p> <p>✓ WI</p> |
| <p>C S34512P
(1x6 S4SSE)
3/4" x 5-1/2"</p> <p>✓ WI</p> | <p>D WOCM003
Classical Colonial
1-5/8" x 4"</p> <p>✓ WI</p> |

P FINGER JOINTED & PRIMED	C CLEAR PINE	FP FJ POPLAR DOUBLE PRIMED	WI WINDSORONE TRIPLE COAT PRIME	F FLEXIBLE	<input checked="" type="checkbox"/> STOCK
M MEDIUM DENSITY FIBERBOARD	CP CLEAR POPLAR	SP SOLID POPLAR (NO FJ) DOUBLE PRIMED	M METRIE 3 DAY LEAD TIME	V CURVED, PG. 58	NS NON-STOCK AVAILABLE FOR QUICK DELIVERY

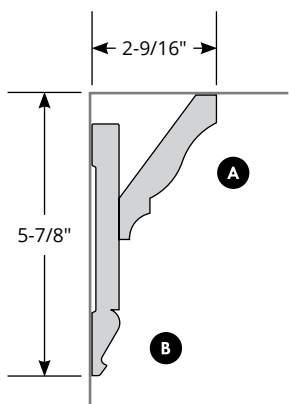
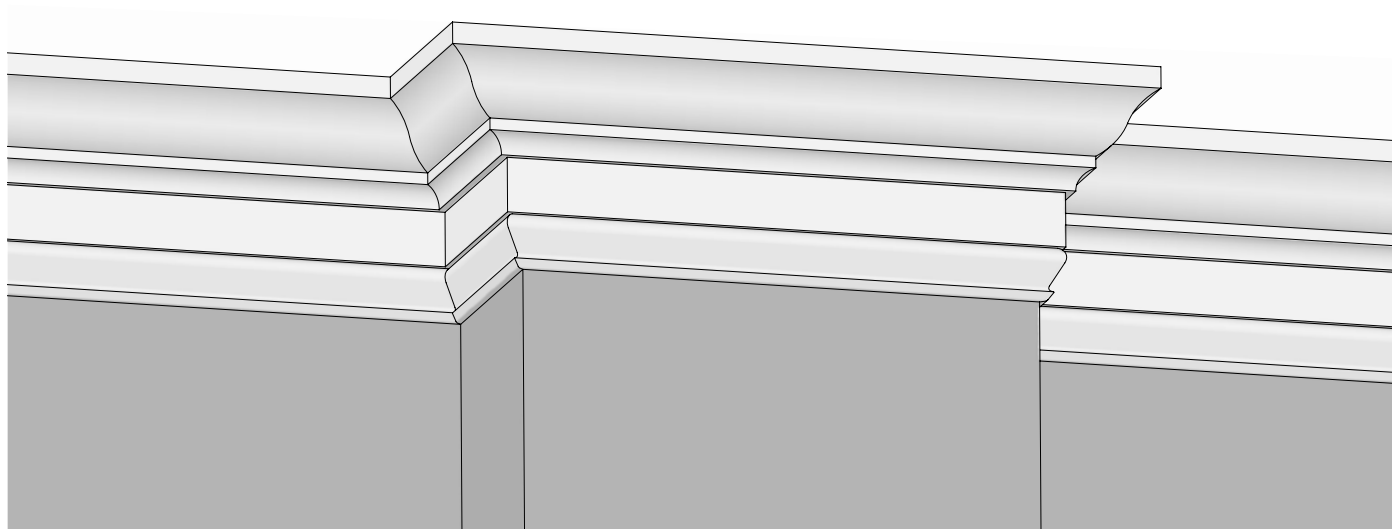

A WM49 (8009)
 9/16" x 3-5/8"

P

B WMSBASE
 9/16" x 5-1/4"

P C M

P FINGER JOINTED & PRIMED

C CLEAR PINE

FP FJ POPLAR DOUBLE PRIMED

W WINDSORONE TRIPLE COAT PRIME

F FLEXIBLE

STOCK

M MEDIUM DENSITY FIBERBOARD

CP CLEAR POPLAR

SP SOLID POPLAR (NO FJ) DOUBLE PRIMED

M METRIE 3 DAY LEAD TIME

V CURVED, PG. 58

NS NON-STOCK AVAILABLE FOR QUICK DELIVERY

BUILT-UP CROWNS

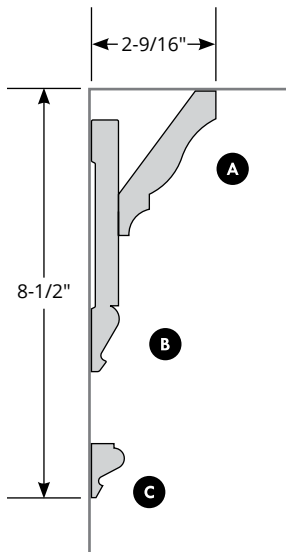
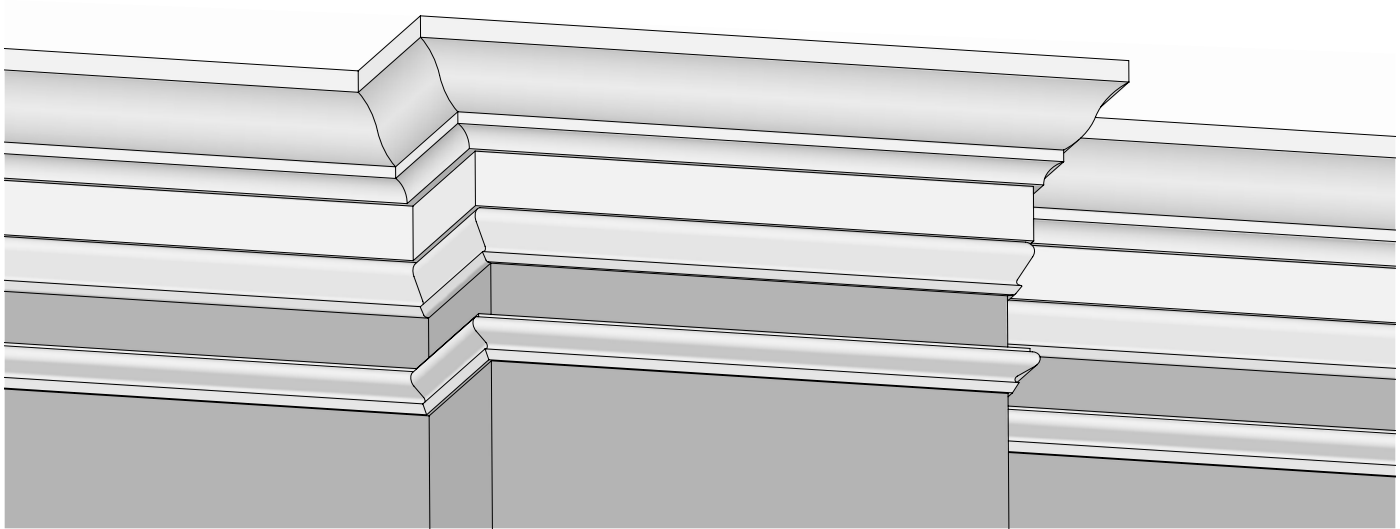

A WM49 (8009)
11/16" x 3-5/8"
 P

B WMSBASE
9/16" x 5-1/4"
 P C M

C WM164 (8453)
11/16" x 1-1/8"
 P

P FINGER JOINTED & PRIMED
 M MEDIUM DENSITY FIBERBOARD

C CLEAR PINE
 CP CLEAR POPLAR

FP FJ POPLAR DOUBLE PRIMED
 SP SOLID POPLAR (NO FJ) DOUBLE PRIMED

W WINDSORONE TRIPLE COAT PRIME
 M METRIE 3 DAY LEAD TIME

F FLEXIBLE
 V CURVED, PG. 58

STOCK
 NS NON-STOCK AVAILABLE FOR QUICK DELIVERY

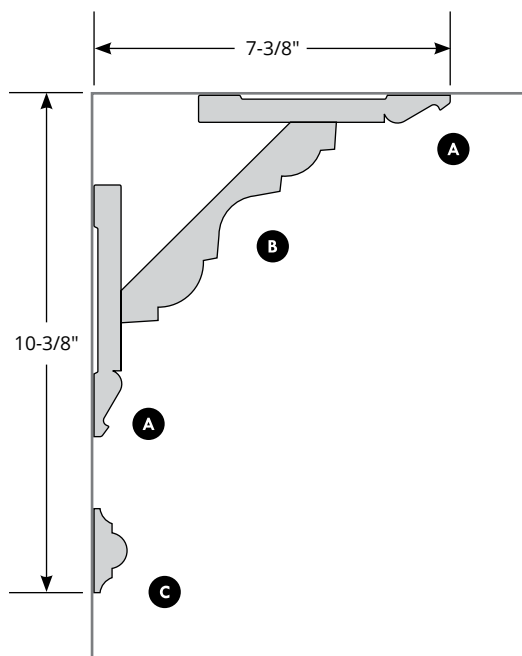
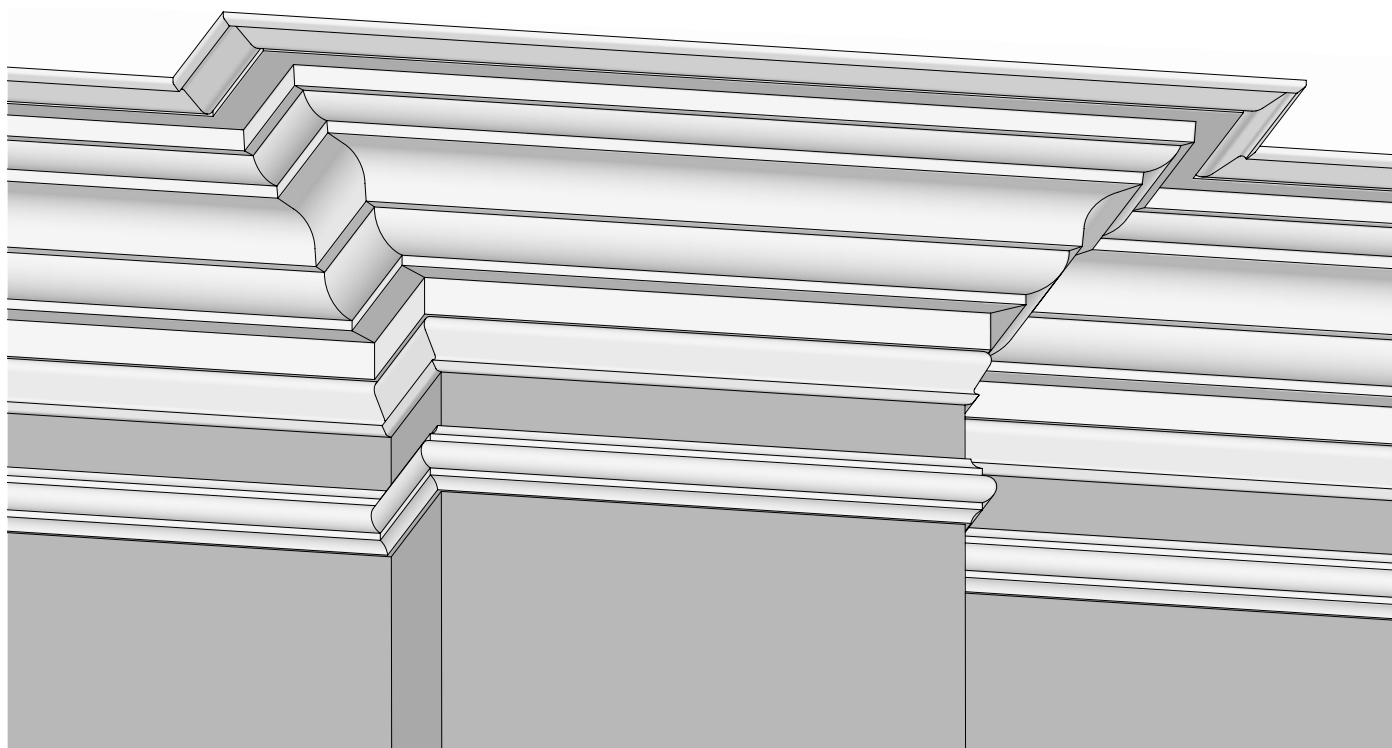

- A** WMSBASE
9/16" x 5-1/4"

P C M
- B** N-1605
1-1/16" x 6-1/8"

SP
- C** WM133 (8171)
11/16" x 1-3/4"

P

P FINGER JOINTED & PRIMED	C CLEAR PINE	FP FJ POPLAR DOUBLE PRIMED	W WINDSORONE TRIPLE COAT PRIME	F FLEXIBLE	<input checked="" type="checkbox"/> STOCK
M MEDIUM DENSITY FIBERBOARD	CP CLEAR POPLAR	SP SOLID POPLAR (NO FJ) DOUBLE PRIMED	M METRIE 3 DAY LEAD TIME	V CURVED, PG. 58	<input type="checkbox"/> NS NON-STOCK AVAILABLE FOR QUICK DELIVERY

BUILT-UP CROWNS

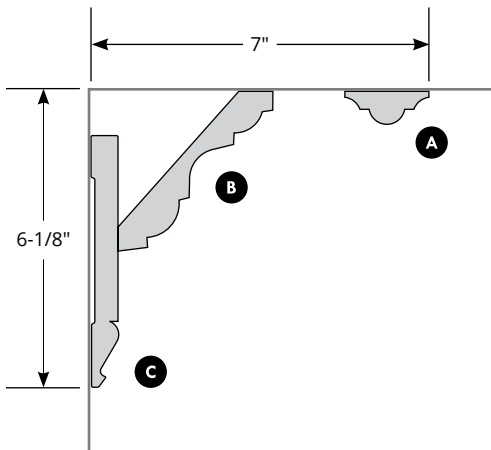
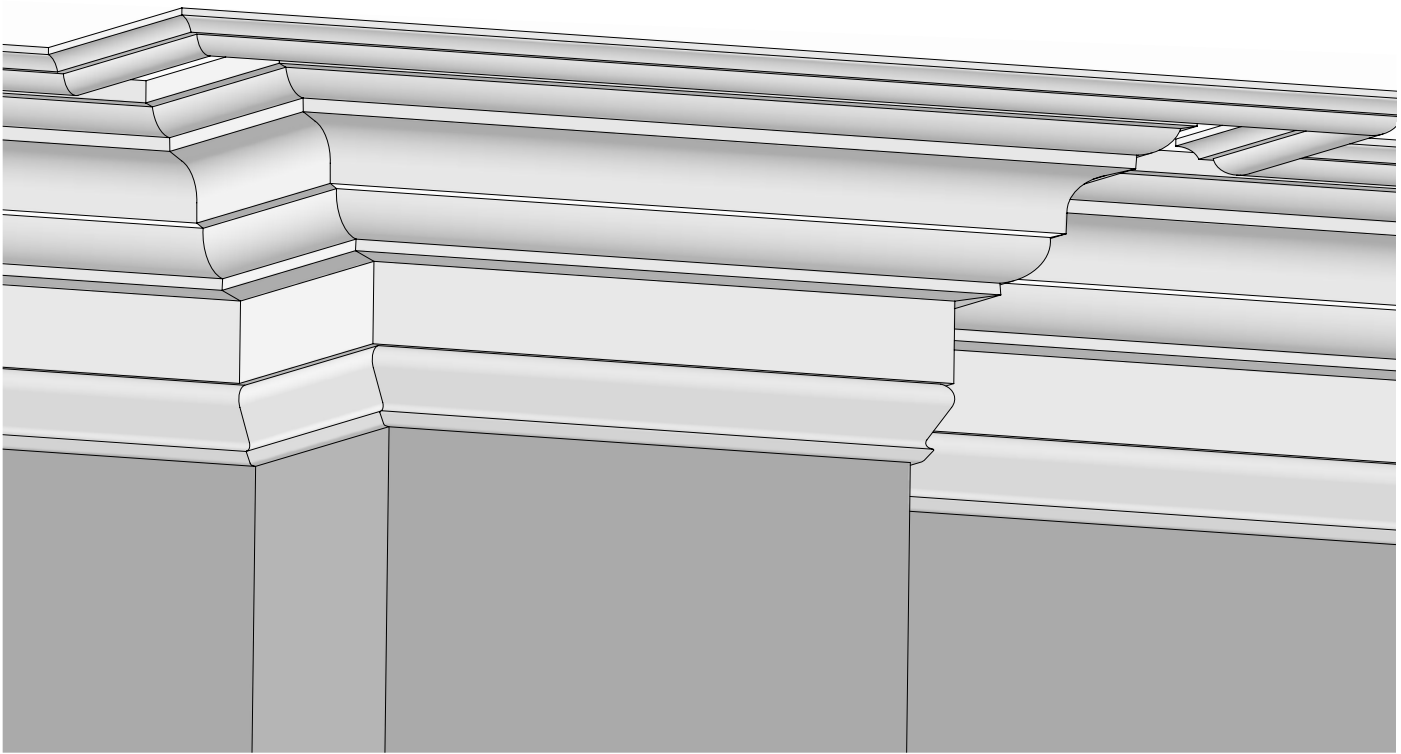

A WM133 (8171)
11/16" x 1-3/4"
 P

B N-1943
13/16" x 4-5/8"
 FP

C WMSBASE
9/16" x 5-1/4"
 P C M

P FINGER JOINTED & PRIMED
 M MEDIUM DENSITY FIBERBOARD

C CLEAR PINE
 CP CLEAR POPLAR

FP FJ POPLAR DOUBLE PRIMED
 SP SOLID POPLAR (NO FJ) DOUBLE PRIMED

W WINDSORONE TRIPLE COAT PRIME
 M METRIE 3 DAY LEAD TIME

F FLEXIBLE
 V CURVED, PG. 58

STOCK
 NS NON-STOCK AVAILABLE FOR QUICK DELIVERY

Rosettes

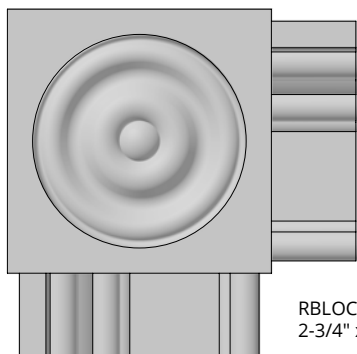

RBLOCK234 Standard Bullseye
2-3/4" x 2-3/4" x 3/4"

shown with WMBWINDSOR

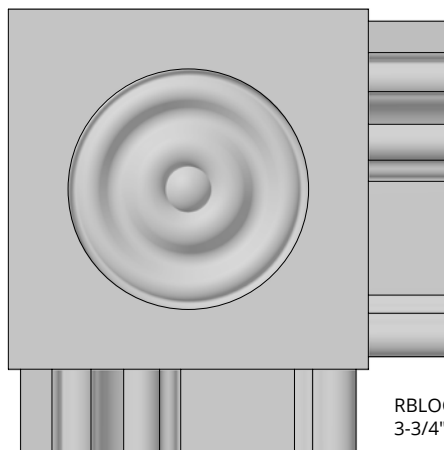

RBLOCK3114 Standard Bullseye
3-3/4" x 3-3/4" x 1-1/4"

shown with WMWINDSOR

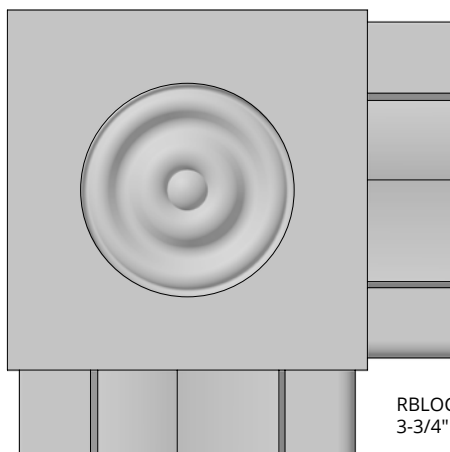

RBLOCK334 Standard Bullseye
3-3/4" x 3-3/4" x 3/4"

shown with WM444 (8754)

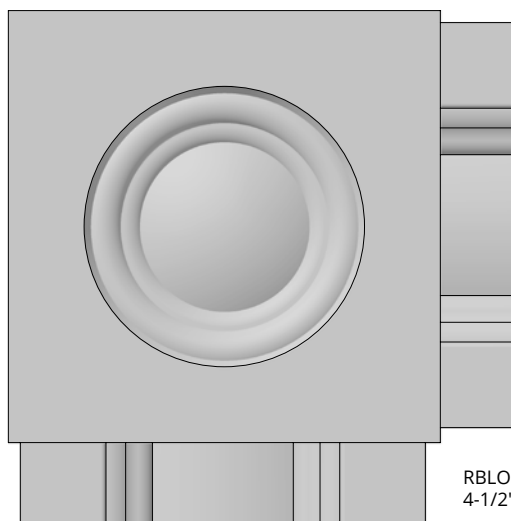

RBLOCK41 Belly Band Bullseye
4-1/2" x 4-1/2" x 1"

shown with WMB100

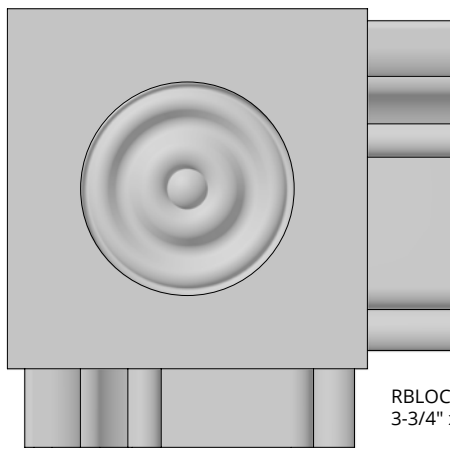

RBLOCK31 Standard Bullseye
3-3/4" x 3-3/4" x 1"

shown with WMSTAFFP



<input type="checkbox"/> P FINGER JOINTED & PRIMED	<input type="checkbox"/> C CLEAR PINE	<input type="checkbox"/> FP FJ POPLAR DOUBLE PRIMED	<input type="checkbox"/> W WINDSORONE TRIPLE COAT PRIME	<input type="checkbox"/> F FLEXIBLE	<input checked="" type="checkbox"/> STOCK
<input type="checkbox"/> M MEDIUM DENSITY FIBERBOARD	<input type="checkbox"/> CP CLEAR POPLAR	<input type="checkbox"/> SP SOLID POPLAR (NO FJ) DOUBLE PRIMED	<input type="checkbox"/> M METRIE 3 DAY LEAD TIME	<input type="checkbox"/> V CURVED, PG. 58	<input type="checkbox"/> NS NON-STOCK AVAILABLE FOR QUICK DELIVERY

9" SAMPLES AVAILABLE UPON REQUEST. ALL MOULDINGS AVAILABLE IN ANY HARDWOOD OR SOFTWOOD SPECIES WITH SHORT LEAD TIME. AVAILABLE UNFINISHED, DOUBLE PRIMED, CLEAR FINISHED, STAINED OR PAINTED. WE HAVE KNIVES FOR OVER 5,000 PATTERNS AND WE ADD NEW CUSTOM PATTERNS EVERY DAY!

STOOL CAP & NOSING

Stool Cap & Nosing



WOWS002
Classical Craftsmen
1-1/16" x 4-1/4"

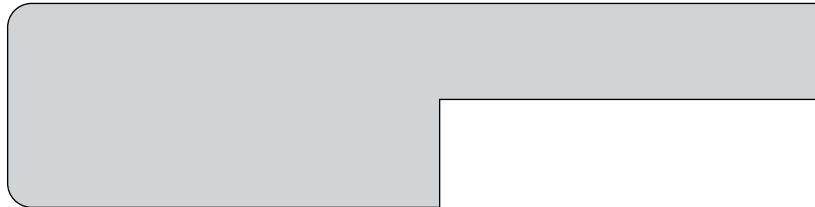

WM1021B
6-9/16 wall
11/16" x 4-1/4"



WM1274
6-9/16 wall
11/16" x 5-3/16"

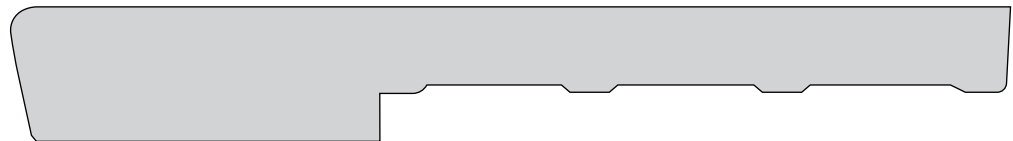

P FINGER JOINTED & PRIMED
M MEDIUM DENSITY FIBERBOARD

C CLEAR PINE
CP CLEAR POPLAR

FP FJ POPLAR DOUBLE PRIMED
SP SOLID POPLAR (NO FJ) DOUBLE PRIMED

W WINDSORONE TRIPLE COAT PRIME
M METRIE 3 DAY LEAD TIME

F FLEXIBLE
V CURVED, PG. 58

✓ STOCK
NS NON-STOCK AVAILABLE FOR QUICK DELIVERY



WOWS001
 Colonial Revival
 1-1/16" x 4-1/2"

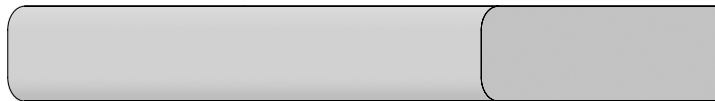

N-91
 Flat Nosed Stool
 1" x 3-1/2"

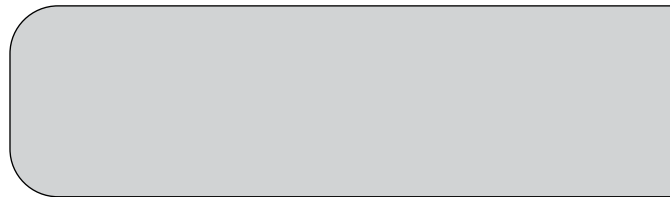

N-91
 Flat Nosed Stool
 1" x 5-1/2"



P FINGER JOINTED & PRIMED	C CLEAR PINE	FP FJ POPLAR DOUBLE PRIMED	W WINDSORONE TRIPLE COAT PRIME	F FLEXIBLE	<input checked="" type="checkbox"/> STOCK
M MEDIUM DENSITY FIBERBOARD	CP CLEAR POPLAR	SP SOLID POPLAR (NO FJ) DOUBLE PRIMED	M METRIE 3 DAY LEAD TIME	V CURVED, PG. 58	NS NON-STOCK AVAILABLE FOR QUICK DELIVERY

STOOL CAP & NOSING

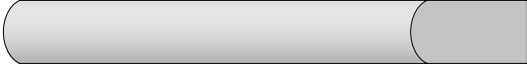

WM8144
11/16" x 1-3/4"



N-761
544PRMBULL
1" x 3-1/2"



N-761
546PRMBULL
1" x 5-1/2"

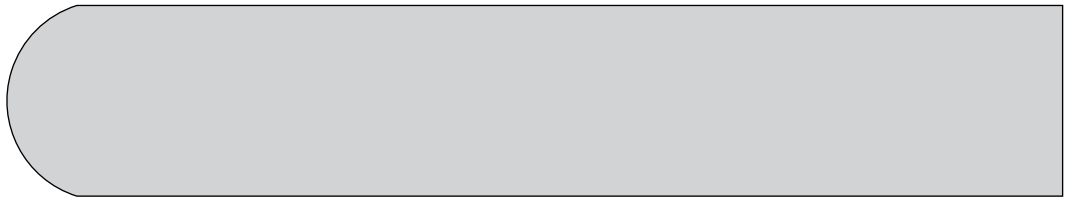

P FINGER JOINTED & PRIMED
 M MEDIUM DENSITY FIBERBOARD

C CLEAR PINE
 CP CLEAR POPLAR

FP FJ POPLAR DOUBLE PRIMED
 SP SOLID POPLAR (NO FJ) DOUBLE PRIMED

W WINDSORONE TRIPLE COAT PRIME
 M METRIE 3 DAY LEAD TIME

F FLEXIBLE
 V CURVED, PG. 58

STOCK
 NS NON-STOCK AVAILABLE FOR QUICK DELIVERY

Bead Board

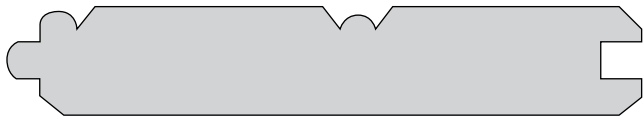

SPBC4 5/8 x 4
 5/8" x 3-5/16"

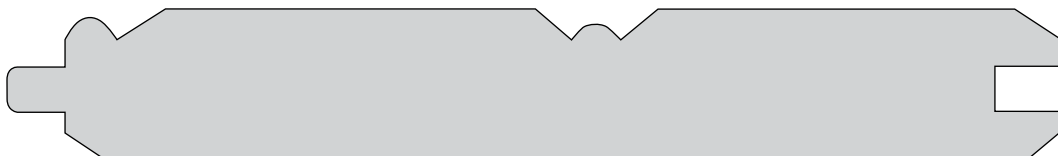

WOBC6 1 x 6
 3/4" x 5-3/8"

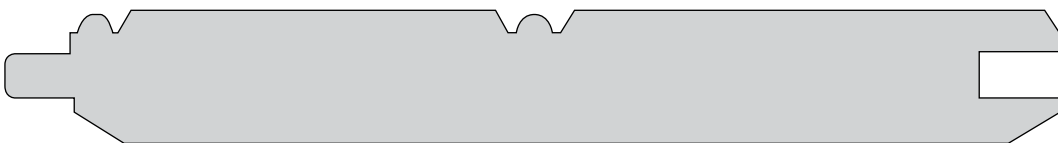

SPBC6 1 x 6
 23/32" x 5-1/2"



WOTG6 1 x 6
 23/32" x 5-1/2"

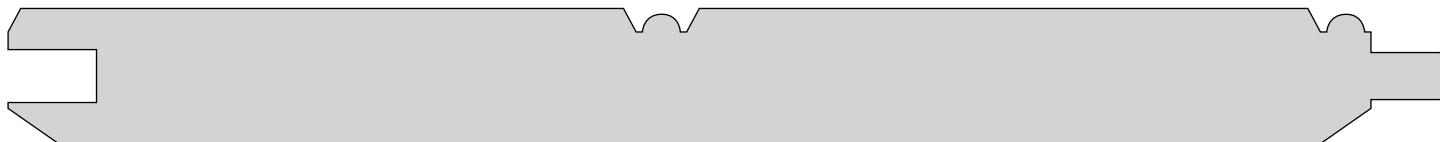

SPBC8 1 x 8
 23/32" x 7-1/2"



P FINGER JOINTED & PRIMED

C CLEAR PINE

FP FJ POPLAR DOUBLE PRIMED

W WINDSORONE TRIPLE COAT PRIME

F FLEXIBLE

STOCK

M MEDIUM DENSITY FIBERBOARD

CP CLEAR POPLAR

SP SOLID POPLAR (NO FJ) DOUBLE PRIMED

M METRIE 3 DAY LEAD TIME

V CURVED, PG. 58

NON-STOCK AVAILABLE FOR QUICK DELIVERY

NICKEL GAP, SHIPLAP

Nickel Gap

PRESET 3/16" GAP



WOSN6
3/4" x 5-1/2"



WOSN8
3/4" x 7-1/4"



Shiplap

CHOOSE YOUR OWN GAP



WORS6
3/4" x 5-1/2"



WORS8
3/4" x 7-1/4"



- | | | | | | |
|--|--|--|---|---|--|
| <input type="checkbox"/> P FINGER JOINTED & PRIMED | <input type="checkbox"/> C CLEAR PINE | <input type="checkbox"/> FP FJ POPLAR DOUBLE PRIMED | <input type="checkbox"/> W WINDSORONE TRIPLE COAT PRIME | <input type="checkbox"/> F FLEXIBLE | <input checked="" type="checkbox"/> STOCK |
| <input type="checkbox"/> M MEDIUM DENSITY FIBERBOARD | <input type="checkbox"/> CP CLEAR POPLAR | <input type="checkbox"/> SP SOLID POPLAR (NO FJ) DOUBLE PRIMED | <input type="checkbox"/> M METRIE 3 DAY LEAD TIME | <input type="checkbox"/> V CURVED, PG. 58 | <input type="checkbox"/> NS NON-STOCK AVAILABLE FOR QUICK DELIVERY |

Flat Trim Boards

	ACTUAL SIZE	WINDSORONE TRADITIONAL TRIPLE PRIMED (MUST FINISH CUT ENDS)	WINDSORONE PROTECTED 30 YEAR WARRANTY (MUST FINISH CUT ENDS)	PRIMED TRIM BOARDS INTERIOR USE	CLEAR PINE GRADE C OR BETTER	CLEAR POPLAR	SOLID POPLAR (NO FJ) DOUBLE PRIMED	MDF
S4S								
1 x 2	3/4" x 1-1/2"							
1 x 3	3/4" x 2-1/2"							
1 x 4	3/4" x 3-1/2"							
1 x 5	3/4" x 4-1/2"							
1 x 6	3/4" x 5-1/2"							
1 x 8	3/4" x 7-1/4"							
1 x 10	3/4" x 9-1/4"							
1 x 12	3/4" x 11-1/4"							
5/4 x 4	1" x 3-1/2"							
	1-1/16" x 3-1/2"							
5/4 x 6	1" x 5-1/2"							
	1-1/16" x 5-1/2"							
5/4 x 8	1" x 7-1/4"							
	1-1/16" x 7-1/4"							
5/4 x 10	1" x 9-1/4"							
	1-1/16" x 9-1/4"							
5/4 x 12	1-1/16" x 11-1/4"							
LATTICE								
WM267 (8281)	9/32" x 1-3/8"							
WM265 (8282)	9/32" x 1-3/4"							
MDF1468	1/4" x 4" x 8'							
MDF1488	1/4" x 6" x 8'							
MDF14128	1/4" x 12" x 8'							

FINGER JOINTED & PRIMED	CLEAR PINE	FJ POPLAR DOUBLE PRIMED	WINDSORONE TRIPLE COAT PRIME	FLEXIBLE	STOCK
MEDIUM DENSITY FIBERBOARD	CLEAR POPLAR	SOLID POPLAR (NO FJ) DOUBLE PRIMED	METRIE 3 DAY LEAD TIME	CURVED, PG. 58	NON-STOCK AVAILABLE FOR QUICK DELIVERY

ASTRAGAL, APRON, BAND

Astragal

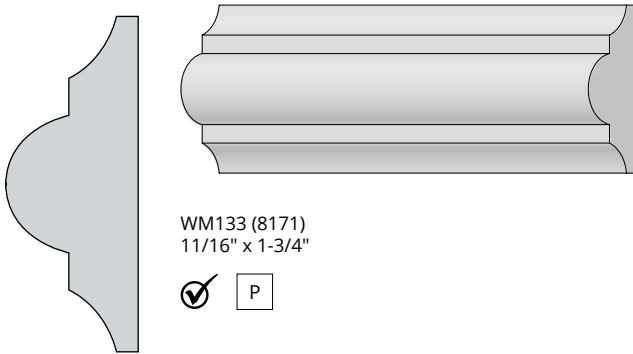

WM133 (8171)
11/16" x 1-3/4"

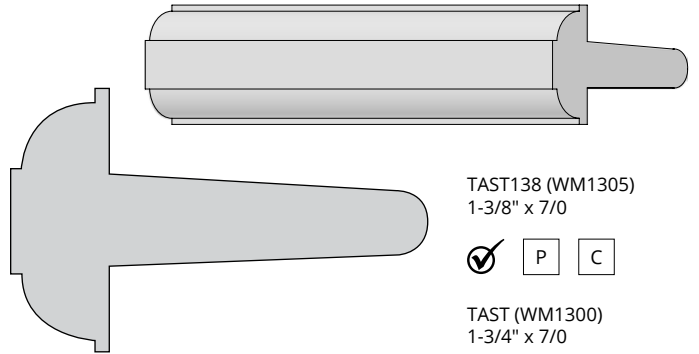

TAST138 (WM1305)
1-3/8" x 7/0

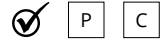

TAST (WM1300)
1-3/4" x 7/0



TASTWS Weatherstripped
1-3/4" x 7/0



Apron



WOCS004 Classical Craftsmen
3/4" x 3-9/16"



WOCS006 Colonial Revival
3/4" x 3-9/16"



Band

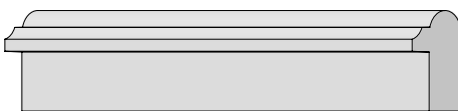

N-488
11/16" x 1-1/32"

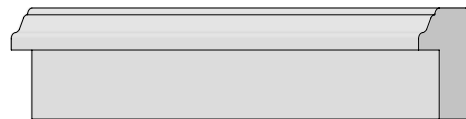
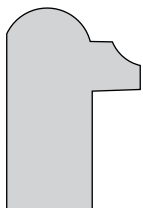

N-405
25/32" x 1-5/32"

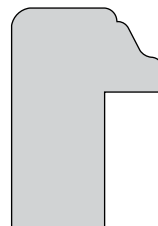

P FINGER JOINTED & PRIMED
 M MEDIUM DENSITY FIBERBOARD

C CLEAR PINE
 CP CLEAR POPLAR

FP FJ POPLAR DOUBLE PRIMED
 SP SOLID POPLAR (NO FJ) DOUBLE PRIMED

WI WINDSORONE TRIPLE COAT PRIME
 M METRIE 3 DAY LEAD TIME

F FLEXIBLE
 V CURVED, PG. 58

STOCK
 NS NON-STOCK AVAILABLE FOR QUICK DELIVERY

Band (cont.)

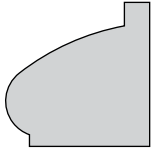

WOBB002 Greek Revival
 3/4" x 3/4"

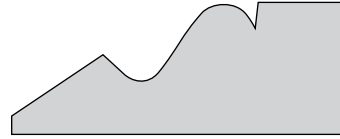
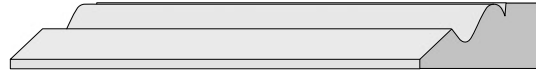

WM217
 11/16" x 1-3/4"

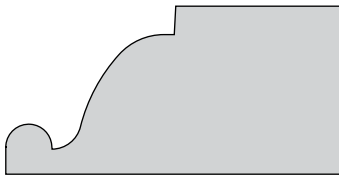
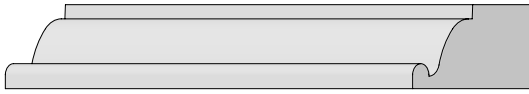

WOBB001 Classical Colonial
 7/8" x 1-3/4"



Bead



N-515
 3/4" x 3/8"

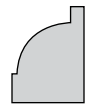

WM8590
 3/8" x 1/2"



Bolection Moulding

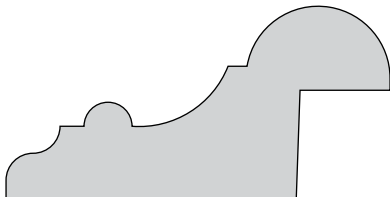
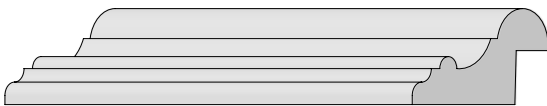

N-10
 1" x 2"

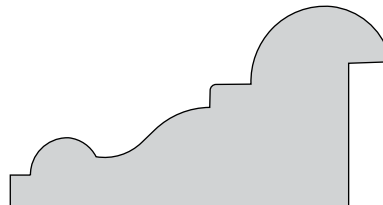
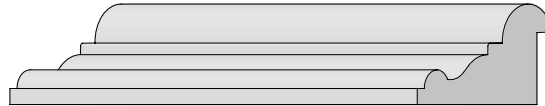

N-489
 1-1/16" x 1-15/16"



P FINGER JOINTED & PRIMED	C CLEAR PINE	FP FJ POPLAR DOUBLE PRIMED	W WINDSORONE TRIPLE COAT PRIME	F FLEXIBLE	<input checked="" type="checkbox"/> STOCK
M MEDIUM DENSITY FIBERBOARD	CP CLEAR POPLAR	SP SOLID POPLAR (NO FJ) DOUBLE PRIMED	M METRIE 3 DAY LEAD TIME	V CURVED, PG. 58	NS NON-STOCK AVAILABLE FOR QUICK DELIVERY

CLOSET POLE, COVE, HAND RAIL

Closet Pole



WM233 (8912)
Fir
1-1/4"

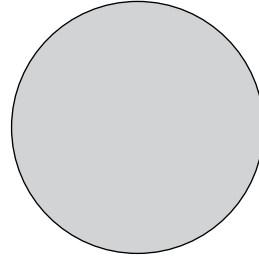

Cove

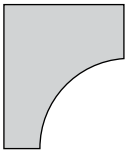

WM96 (8062)
Scotia
5/8" x 3/4"

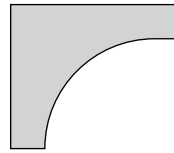

WOCV001
Classical Craftsmen
3/4" x 7/8"



Hand Rail

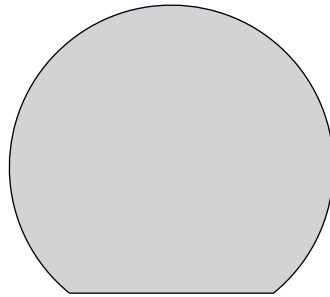

WM231 (#75)
Finger Jointed Fir
1-1/2" x 1-5/8"

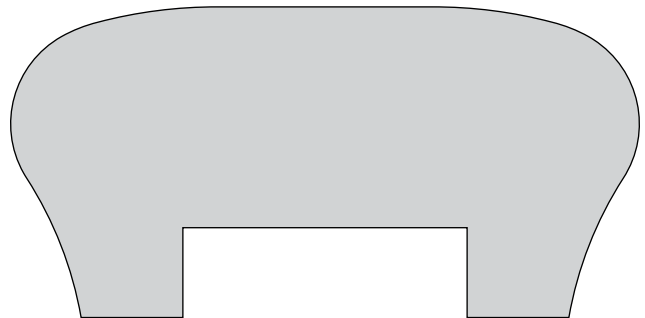

N-1696
1-5/8" x 3-9/32"



P FINGER JOINTED & PRIMED
M MEDIUM DENSITY FIBERBOARD

C CLEAR PINE
CP CLEAR POPLAR

FP FJ POPLAR DOUBLE PRIMED
SP SOLID POPLAR (NO FJ) DOUBLE PRIMED

W WINDSORONE TRIPLE COAT PRIME
M METRIE 3 DAY LEAD TIME

F FLEXIBLE
V CURVED, PG. 58

STOCK
NS NON-STOCK AVAILABLE FOR QUICK DELIVERY

Header Stop & Cap

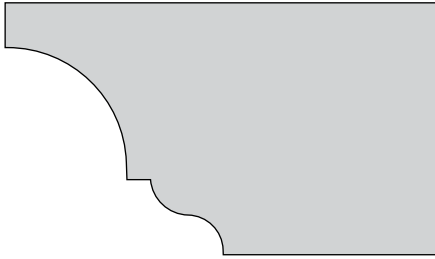
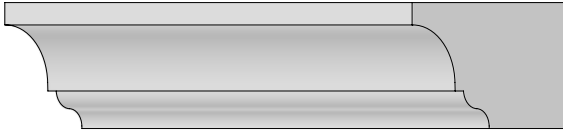

WOHC001
 Classical Craftsmen
 1-5/16" x 2-1/4"



WOST001
 Classical Craftsmen
 7/16" x 1-1/16"



Panel Moulding



WOSP001 Federal
 7/8" x 1-1/4"

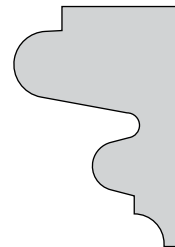

Picture Moulding

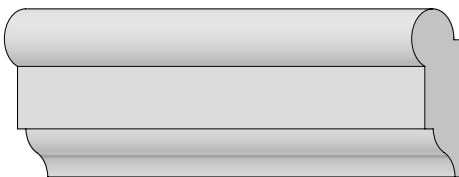

WOPM004
 Colonial Revival
 3/4" x 1-3/4"

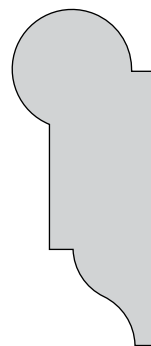

P FINGER JOINTED & PRIMED	C CLEAR PINE	FP FJ POPLAR DOUBLE PRIMED	W WINDSORONE TRIPLE COAT PRIME	F FLEXIBLE	<input checked="" type="checkbox"/> STOCK
M MEDIUM DENSITY FIBERBOARD	CP CLEAR POPLAR	SP SOLID POPLAR (NO FJ) DOUBLE PRIMED	M METRIE 3 DAY LEAD TIME	V CURVED, PG. 58	<input type="checkbox"/> NON-STOCK AVAILABLE FOR QUICK DELIVERY

QUARTER ROUND, STOP

Quarter Round

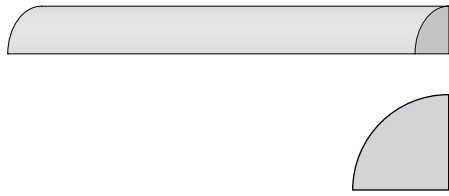

WM108 (8063)
1/2" x 1/2"

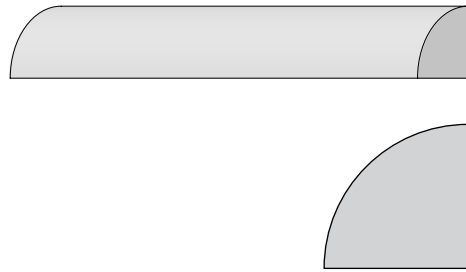

WM105 (8065)
3/4" x 3/4"

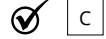

Stop

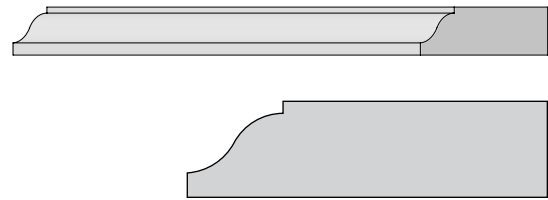

WOST004
Colonial Revival
1/2" x 1-7/8"

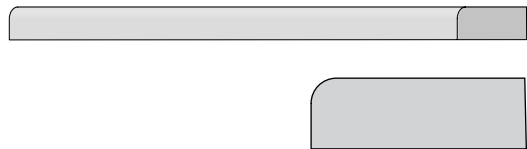

WM888
Flat Stop
3/8" x 1-1/8" x 7/0



WM888
Flat Stop
31/64" x 1-1/8" x 7/3



WM888
Flat Stop
1/2" x 1-1/8" x 8/3

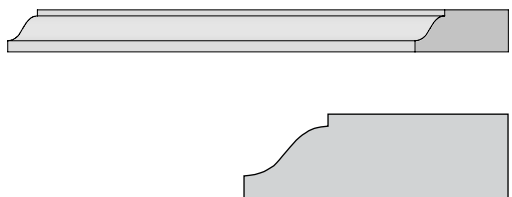

WM936
Colonial Stop
23/64" x 1-3/8" x 7/0



WM936
Colonial Stop
3/8" x 1-3/8" x 7/3



WM936
Colonial Stop
31/64" x 1-3/8" x 8/3



P FINGER JOINTED & PRIMED
M MEDIUM DENSITY FIBERBOARD

C CLEAR PINE
CP CLEAR POPLAR

FP FJ POPLAR DOUBLE PRIMED
SP SOLID POPLAR (NO FJ) DOUBLE PRIMED

W WINDSORONE TRIPLE COAT PRIME
M METRIE 3 DAY LEAD TIME

F FLEXIBLE
V CURVED, PG. 58

STOCK
NS NON-STOCK AVAILABLE FOR QUICK DELIVERY

Wainscot Cap

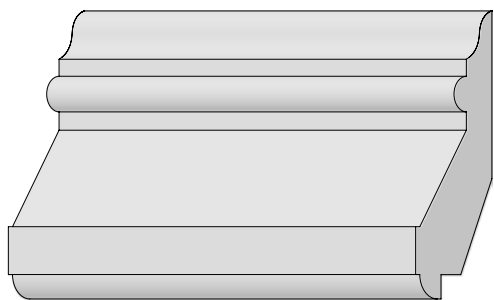

WOWC002
 1-1/8" x 3"

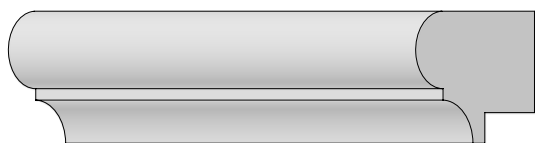
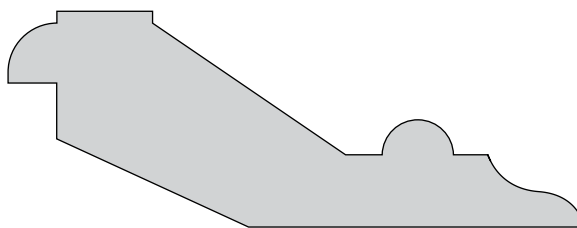

WOWC003
 1-3/8" x 1-3/4"

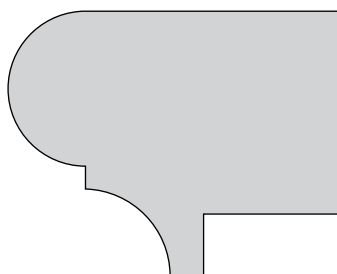

Window Jamb



WEXT
 2 1/32" x 2"

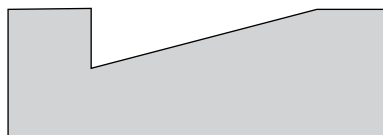

P FINGER JOINTED & PRIMED

C CLEAR PINE

FP FJ POPLAR DOUBLE PRIMED

W WINDSORONE TRIPLE COAT PRIME

F FLEXIBLE

✓ STOCK

M MEDIUM DENSITY FIBERBOARD

CP CLEAR POPLAR

SP SOLID POPLAR (NO FJ) DOUBLE PRIMED

M METRIE 3 DAY LEAD TIME

V CURVED, PG. 58

NS NON-STOCK AVAILABLE FOR QUICK DELIVERY





Wholesale Doors
COMMERCIAL DIVISION

For our complete offering of interior millwork and other products and services, please visit our website:
CLEARYWHOLESALE.COM



1255B Grand Army Highway, Somerset, MA 02726
PHONE 800-899-4533

2049 Silas Deane Highway, Suite 1A, Rocky Hill, CT 06067
PHONE 800-486-7600

120 Defreest Drive, Suite 19 (Rensselaer Technology Park), Troy, NY 12180
PHONE 800-350-0448

WHOLESALE DOORS
220 Forbes Road, Suite 403, Braintree, MA 02184
PHONE 800-225-4252